



Bauer Maschinen

# Service-Katalog

Equipment and Accessories

DE | EN

N° 8



## Technical Support



**+800 1000 1200**  
(toll-free number, where available) or

**+49 8252 97-2888**



**BMA-Service@bauer.de**

Learn more about our  
Service Network





Drehbohrwerkzeuge  
Drilling Tools



Kellystangen  
Kelly Bars



Schlitzwand  
Diaphragm Walls



Misch- und Trenntechnik  
Slurry Handling Systems



Single-Pass-Verfahren  
Single Pass Methods



Instandhaltung  
Maintenance



Elektrik  
Electrics



Hydraulik  
Hydraulics



Zubehör  
Accessories



Service-Koffer  
Service Cases



Werkzeug und Material  
Tools and Consumables



Merchandising  
Merchandising





# Drehbohrwerkzeuge

## Drilling Tools



### Verschleißteile Bohrwerkzeuge – Bohrstrang

#### Wear Parts Drilling Tools – Drill String

· Verschleißteile Drehteller Wear Parts Casing Drive Adapter	6 - 7
· Bohrrohrverschraubungen Casing Screws	8 - 10
· Wechselstollen Replaceable Teeth	12 - 13
· Anschweißstollen Weld-on Teeth	14 - 15
· Flachzähne Flat Teeth	16 - 18
· Rundschaftmeißel Round Shank Chisel	20 - 25
· Rollenmeißel Roller Bits	26
· Verschleißwinkel/-leisten Wear Angles/Wear Strips	27
· Piloten Pilot Bits	28

### Wechselwerkzeuge

#### Exchanging Tools

29 - 36

### Ersatzteile Rohrstrang

#### Spare Parts Casing String

37 - 40

· Rohrverbinder Casing Joints	37
· Schneidringe Rohrschuhe Cutting Rings Casing Shoes	38 - 40

### Ersatzteile Bohrwerkzeuge

#### Spare Parts Drilling Tools

41 - 73

· Schneidringe Kernrohr Cutting Rings Core Barrel	41 - 43
· Drehböden für Kastenbohrer Turn Bottoms for Drilling Buckets	44 - 49
· Schneidleisten für Bohrwerkzeuge Cutting Ledges for Drilling Tools	50 - 56
· Ersatzteile Kastenbohrer einschneidig Spare Parts Drilling Buckets Single Cut	58 - 63
· Ersatzteile Kastenbohrer zweischneidig Spare Parts Drilling Buckets Double Cut	64 - 68
· Allgemeine Verschleiß- und Ersatzteile Bohrwerkzeuge General Wear and Spare Parts Drilling Tools	69 - 70
· Betonierschüttrohre Tremie Pipe Systems	71 - 73

### Ausrüstung Schrägpfähle

#### Equipment for Inclined Drilling





74 - 75

# Verschleißteile Bohrwerkzeuge – Bohrstrang

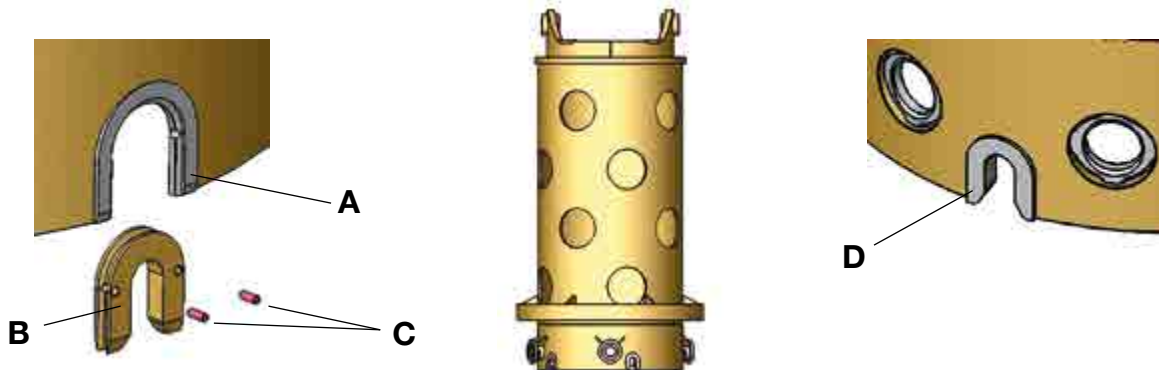
## Wear Parts Drilling Tools – Drill String

### Verschleißteile Drehteller | Wear Parts for Casing Drive Adapter













Position Position	Darstellung Illustration	Bauer-Best.Nr. Bauer Item No.	Bezeichnung Description
A		634107	Halter Einsatzstück Drehteller Ø 880 - 1300 <a href="#">Support Insert Casing Driver</a>
		689226	Halter Einsatzstück Drehteller Ø 1500 - 1800 <a href="#">Support Insert Casing Driver</a>
		853691	Halter Einsatzstück Drehteller Ø 2000 - 2500 <a href="#">Support Insert Casing Driver</a>
B		634128	Einsatzstück Drehteller Ø 880 - 1300 <a href="#">Insert Casing Driver</a>
		689227	Einsatzstück Drehteller Ø 1500 - 1800 <a href="#">Insert Casing Driver</a>
		853676	Einsatzstück Drehteller Ø 2000 - 2500 <a href="#">Insert Casing Driver</a>
C		21403	Spannstift Einsatzstück Ø 880 - 1800 <a href="#">Pin Insert Casing</a>
		87904	Spannstift Einsatzstück Ø 2000 - 2500 <a href="#">Pin Insert Casing</a>
D		204346	Einsatzstück eingeschweißt Ø 620 - 1300 <a href="#">Insert Welded</a>
		204900	Einsatzstück eingeschweißt Ø 1500 - 1800 <a href="#">Insert Welded</a>
		103044	Einsatzstück eingeschweißt Ø 2000 - 2500 <a href="#">Insert Welded</a>

# Verschleißteile Bohrwerkzeuge – Bohrstrang

## Wear Parts Drilling Tools – Drill String



Darstellung Illustration	Bauer-Best.Nr. Bauer Item No.	Bezeichnung Description
	80213	Absteckbolzen Casing Drive Adapter Pin
	109366	Absteckbolzen Casing Drive Adapter Pin
	109369	Führungsstift Locating Pin
	220094	Zyl. Schraube mit Innensechskant Hexagon Socket Head Cap Screw
	26698	Sicherungsscheibe 8 Washer/Disc
	109343	Buchse Ø 620 - 1800 mm Bushing
	109347	Rippe Ø 620 - 1800 mm Rip
	109344	Ring Ø 620 - 1800 mm Ring
	380816	Buchse Ø 2000 - 2500 mm Bushing
	380820	Rippe Ø 2000 - 2500 mm Rip
	380818	Ring Ø 2000 - 2500 mm Ring
	110802	Stange Teleskop kpl. Telescope Rod cpl.

# Verschleißteile Bohrwerkzeuge – Bohrstrang

## Wear Parts Drilling Tools – Drill String

### Bohrrohrverschraubungen | Casing Screws

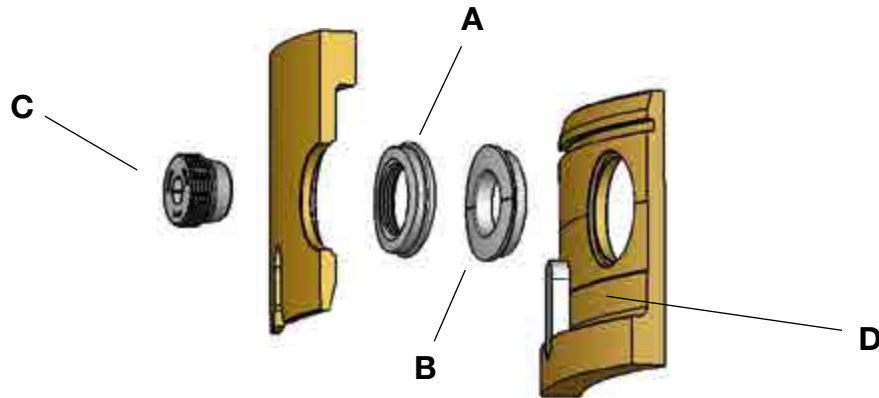

Position Position	Darstellung Illustration	Bauer-Best.Nr. Bauer Item No.	Bezeichnung Description	Ø Bohrruhr (mm) Ø Casing (mm)
A		465873	Gewinding Threaded Ring	620 - 899 (VDW 610)
		465874		900 - 1499
		465875		1500 - 1999
		469930		2000 - 2500
		1350789		406
		1350790		508
B		465878	Konusring Conical Ring	620 - 899 (VDW 610)
		465879		900 - 1499
		465880		1500 - 1999
		469931		2000 - 2500
		1351120		406
		1351241		508
C		206981	Rohrschraube Casing Screw	620 - 1499 Sechskant SW 27   Hexagon
		206982		1500 - 1999 Sechskant SW 27   Hexagon
		102354		2000 - 2500 Sechskant SW 41   Hexagon
		431748		620 - 1499 Vierkant SW 26, gerundet   Square, r. shape
		431749		1500 - 1999 Vierkant SW 26, gerundet   Square, r. shape
		1351471		406 - 508 Sechskant SW 27   Hexagon
		859079	Verschlusschraube Sealing Plug	620 - 1999 Vierkant SW 28   Square
		859141		2000 - 2500 Vierkant SW 28   Square
D		85254	Passfeder Key	620 - 1499
		700603		1500 - 1999
		102892		2000 - 2500
		1202486		406 - 508
-		220591	Zubehör Accessories	Mehrzwecktuch 10 kg Multipurpose Towel

# Verschleißteile Bohrwerkzeuge – Bohrstrang



## Wear Parts Drilling Tools – Drill String



### Vorteile der BAUER-Bohrrohrschrauben















#### Advantages of the BAUER Casing Screws



Darstellung Illustration	Bauer-Best.Nr. Bauer Item No.	Bezeichnung Description	Ø Bohrröhr (mm) Ø Casing (mm)			
	45368	O-Ring (Schraube)	620 / 750 / 880 / 1000 / 1180 / 1300 / 1500 / 1800			
	40018	O-Ring (Screw)	2000 / 2200 / 2500			
	52275	O-Ring / Dichtung Röhrverbinder	620 (535)			
	52276		750 (665)			
	52277		880 (790)			
	52278		1000 (910)			
	52279		1180 (1090)			
	52280		1300 (1210)			
	52281		1500 (1400)			
	52282		1800 (1695)			
	358603		2000 (1870)			
	358604		2200 (2070)			
358605	2500 (2360)					
Darstellung Illustration	Bauer-Best.Nr. Bauer Item No.			Ø Bohrröhr (mm) Ø Casing (mm)	Anzahl Bohrröhrschrauben/O-Ringe Quantity Casing Screws/O-Rings	
Bezeichnung Description	Vierkant (SW 28) Square Bolt	Sechskant (SW 27) Hexagon Bolt				
	1284815	503779	620	8		
	1284817	503781	750	10		
	1284818	503782	880	10		
	1284819	503784	1000	10		
	1284820	503788	1180	12		
	1284841	503790	1300	12		
	1284842	504949	1500	12		
	1284843	504951	1800	16		
			Sechskant (SW 41) Hexagon Bolt			
	-	504952		2000	18	
-	504953		2200	18		
-	504954		2500	24		
Komplettsatz Bohrrohrverbindung inkl. Schrauben, O-Ringe, Dichtung (für je ein Röhr)						
Entire Kit Casing Screws incl. Casing Screws Sealing Rings Sealing Ring, Casing Joint (for one Casing)						

# Verschleißteile Bohrwerkzeuge – Bohrstrang

## Wear Parts Drilling Tools – Drill String

Werkzeuge – Bohrrohrverschraubung		Tools – Casing Screws
Darstellung Illustration	Bauer-Best.Nr. Bauer Item No.	Bezeichnung Description
	206979	Bohrrohrschlüssel Sechskant SW 27 Wrench Hexagon
	641254	Bohrrohrschlüssel Sechskant SW 41 Wrench Hexagon
	1194316	Bohrrohrschlüssel Vierkant SW 26 Wrench Square
	52295	Bohrrohrschlüssel Vierkant SW 28 Wrench Square
	460585	Schlagschlüssel Sechskant SW 27 Bump Key Hexagon
	641271	Schlagschlüssel Sechskant SW 41 Bump Key Hexagon
	464939	Schlagschlüssel Vierkant SW 26 Bump Key Square
	457044	Schlagschlüssel Vierkant SW 28 Bump Key Square
	726723	Druckluftschlagschrauber 3/4“ Air Impact Wrench
	1084811	Akku M18B5 Li-Ion 18 V/5,0 Ah Accumulator
	1340519	Ladegerät 24 V -> 18 V Charger
	1087850	Akkuschlagschrauber 18 V Rechargeable Impact Wrench
	726772	Steckschlüsseinsatz 3/4“ Sechskant SW 27 Wrench Insert Hexagon
	278881	Verbindungsstück 3/4“ – 1“ (für Konusschrauben Vierkant SW 26 und SW 28) Connection Piece (for Casing Screws Square)
	924830	Steckschlüsseinsatz 3/4“ Sechskant SW 41 Connection Piece (for CS Hexagon)
	1350054	Reinigungsbürste Bohrrohrverschraubung Cleaning Brush for Casing Connection
	1377819	Reinigungswerkzeug Rohrschraube Cleaning Tool Casing Screw

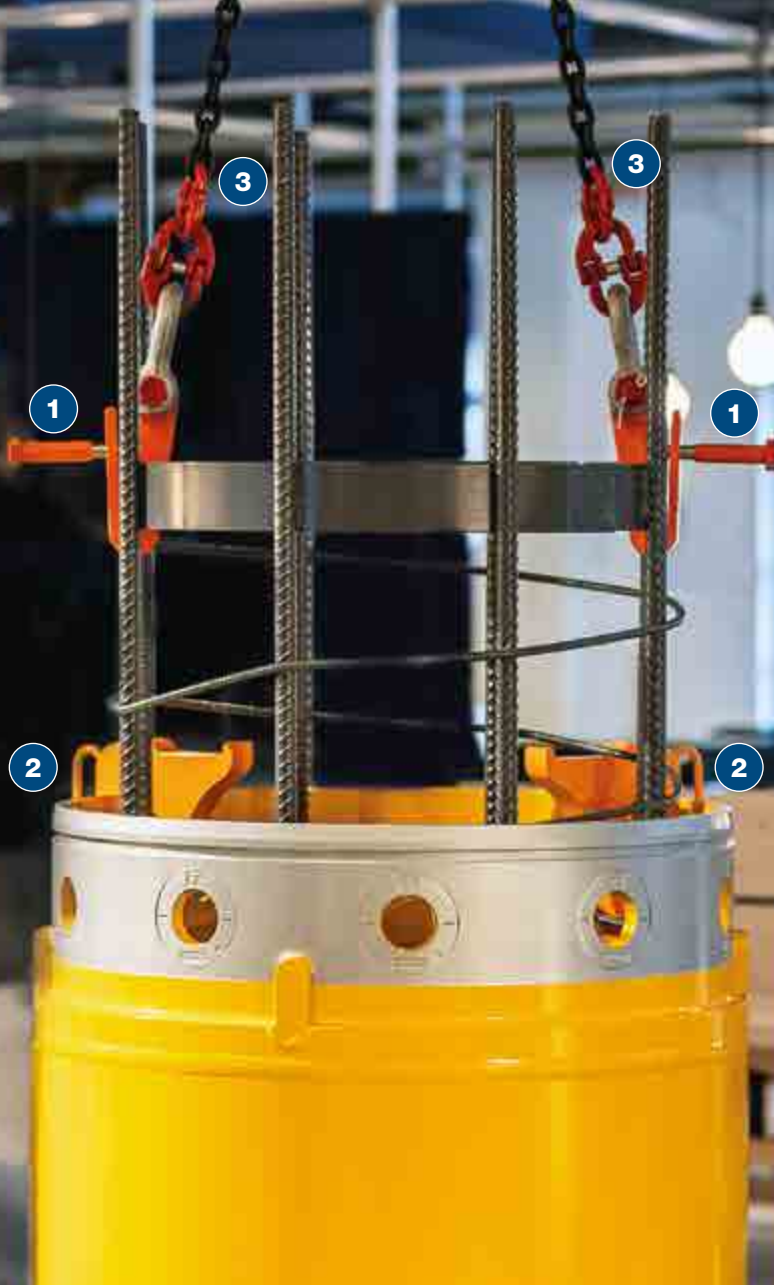

- 1** 1418074 Korbeinhebehaken für Bewehrungskörbe | Lifting Hook for Reinforcement Cage
- 2** 1467787 Korbriegel | Basket Bar
- 3** 1421989 Anschlagkette 2-strängig, L: 3000 mm | Chain Sling 2 stranded

## Zertifizierter Korbeinhebehaken *Certified Lifting Hook*

### Ihre Vorteile:

- Sehr sicheres Ver- und Einheben des Bewehrungskorbs
- Schneller Einbau des Bewehrungskorb
- Geschlossenes Anschlagmittel während dem Verhebe-Vorgang
- Kein unnötiges Hineingreifen in den abgelassenen Bewehrungskorb, um das Anschlagmittel zu öffnen
- Kein Ablegen des Bewehrungskorbs auf einem anderweitigen Hilfsmittel
- Einfaches Aushängen des Hebemittels aus dem in die Bohrung abgelassenen Bewehrungskorb
- Hakenlast: 8 t (max.)

### Advantages:

- *Very safe lifting and lowering of the reinforcement cage*
- *Quick installation of the reinforcement cage*
- *Closed lifting gear during the lifting process*
- *No unnecessary reaching into the lowered reinforcement cage to open the lifting gear*
- *No need to place the reinforcement cage on another (unsafe) piece*
- *Easy removal of the lifting device from the lowered reinforcement cage*
- *Hook load: 8 tons (max.)*

# Verschleißteile Bohrwerkzeuge – Bohrstrang

## Wear Parts Drilling Tools – Drill String

### Wechselstollen | Replaceable Teeth

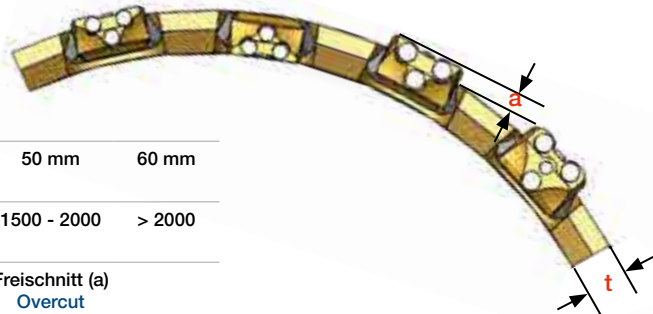

Rohrwandstärke (t) Casing Wall Thickness	40 mm	50 mm	60 mm
Bohrrohr-Außendurchmesser Casing Outer Diameter	< 1500	1500 - 2000	> 2000
Typ Type	Freischnitt (a) Overcut		
WS 39 / WS 39-R / WS 39-T	7 mm	-	-
WS 46 / WS 46-R	13 mm	7 mm	-
WS 52 / WS 52-R	18 mm	13 mm	7 mm

Darstellung Illustration	Bauer-Best.Nr. Bauer Item No.	Darstellung Illustration	Bauer-Best.Nr. Bauer Item No.
	Bezeichnung Description		Bezeichnung Description
	453255		450920
	WS 20 Wechselstollen Replaceable Teeth		WS 46 Wechselstollen Replaceable Teeth
	1351219		636906
	WS 29-R Wechselstollen Replaceable Teeth		WS 52 Wechselstollen Replaceable Teeth
	126208		1351078
	WS 39 Wechselstollen Replaceable Teeth		WSH 29 Wechselstollen Halter Replaceable Teeth Holder

# Verschleißteile Bohrwerkzeuge – Bohrstrang

## Wear Parts Drilling Tools – Drill String











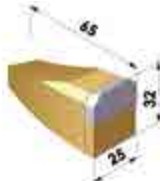









Darstellung Illustration	Bauer-Best.Nr. Bauer Item No.	Darstellung Illustration	Bauer-Best.Nr. Bauer Item No.
	Bezeichnung Description		Bezeichnung Description
	403369		985628
	WS 39-T Wechselstollen Replaceable Teeth		WS 52-R Wechselstollen Replaceable Teeth
	792281		453253
	WS 39-R Wechselstollen Replaceable Teeth		WSH 20 Wechselstollen Halter Holder Replaceable Teeth
	921821		126207
	WS 46-R Wechselstollen Replaceable Teeth		WSH 39-52 Wechselstollen Halter Holder Replaceable Teeth
	1354827		462946
	WS 46-VS Wechselstollen Replaceable Teeth		Pin WS 20
			1294205
			Pin WS 29
			362432
			Pin WS 39
			18297
		Pin WS 46/52	

# Verschleißteile Bohrwerkzeuge – Bohrstrang

## Wear Parts Drilling Tools – Drill String



















### Anschweißstollen | Weld-on Teeth

Darstellung Illustration	Bauer-Best.Nr. Bauer Item No.	Darstellung Illustration	Bauer-Best.Nr. Bauer Item No.	Darstellung Illustration	Bauer-Best.Nr. Bauer Item No.
	Bezeichnung Description		Bezeichnung Description		Bezeichnung Description
 	205065	 	1035218	 	1035219
	<p>AZ 25 x 65 x 32-1-R Anschweißzahn Weld-on Teeth</p>		<p>AZ 25 x 65 x 32-1-L Anschweißzahn Weld-on Teeth</p>		<p>AZ 25 x 71 x 25-1 Anschweißzahn Weld-on Teeth</p>
 	204677	 	1035220	 	1035212
	<p>AZ 32 x 90 x 67-4 Anschweißzahn Weld-on Teeth</p>		<p>AZ 47 x 75 x 85-4 Anschweißzahn Weld-on Teeth</p>		<p>AS 16 x 54 x 36-3 Anschweißstollen Weld-on Teeth</p>
 	77804	 	305149	 	1035213
	<p>AS 22 x 55 x 43-4 Anschweißstollen Weld-on Teeth</p>		<p>AS 27 x 52 x 49-5 Anschweißstollen Weld-on Teeth</p>		<p>AS 32 x 50 x 47-7 Anschweißstollen Weld-on Teeth</p>



# Verschleißteile Bohrwerkzeuge – Bohrstrang

## Wear Parts Drilling Tools – Drill String

Darstellung Illustration	Bauer-Best.Nr. Bauer Item No.	Darstellung Illustration	Bauer-Best.Nr. Bauer Item No.	Darstellung Illustration	Bauer-Best.Nr. Bauer Item No.
	Bezeichnung Description		Bezeichnung Description		Bezeichnung Description
 	1035214	 	100436	 	96482
	AS 33 x 63 x 39-5 Anschweißstollen Weld-on Teeth		AS 35 x 91 x 48-5 Anschweißstollen Weld-on Teeth		AS 38 x 70 x 47-7 Anschweißstollen Weld-on Teeth
 	1035215	 	1035216	 	846046
	AS 41 x 92 x 66-9 Anschweißstollen Weld-on Teeth		AS 42 x 100 x 67-9 Anschweißstollen Weld-on Teeth		AS 42 x 98 x 66-7 Anschweißstollen Weld-on Teeth
 	214912	 	412471	 	1035217
	AS 43 x 95 x 65-7 Anschweißstollen Weld-on Teeth		AS 55 x 90 x 52-6 Anschweißstollen Weld-on Teeth		AS 58 x 95 x 64-12 Anschweißstollen Weld-on Teeth

# Verschleißteile Bohrwerkzeuge – Bohrstrang

## Wear Parts Drilling Tools – Drill String

### Flachzähne | Flat Teeth

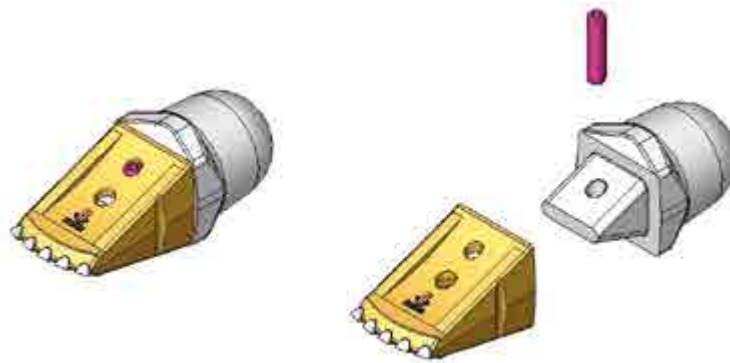

Darstellung Illustration	Bauer-Best.Nr. Bauer Item No.	Darstellung Illustration	Bauer-Best.Nr. Bauer Item No.
	Bezeichnung Description		Bezeichnung Description
	645565		645442
	FZI 54 Flachzahn Flat Teeth		FZI 72 Flachzahn Inverse Flat Teeth Inverse
	645543		645443
	FZHI 54 Flachzahnhalter Inverse Holder Flat Teeth Inverse		FZHI 72 Flachzahnhalter Inverse Holder Flat Teeth Inverse
	21403		1066177
	Pin FZI 54		FZI 72-L Flachzahn Flat Teeth
	29736		Pin FZI 72

# Verschleißteile Bohrwerkzeuge – Bohrstrang











## Wear Parts Drilling Tools – Drill String

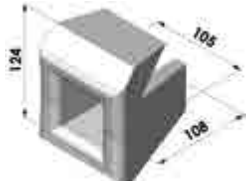

Darstellung Illustration	Bauer-Best.Nr. Bauer Item No.	Darstellung Illustration	Bauer-Best.Nr. Bauer Item No.
	Bezeichnung Description		Bezeichnung Description
	386933		126032
	FZ 54 Flachzahn Flat Teeth		FZH 72 Flachzahnhalter Holder Flat Teeth
	386892		1320252
	FZH 54 Flachzahnhalter Holder Flat Teeth		FZI 72-TL Flachzahn Flat Teeth
	645567		645444
	FZAI 54 Flachzahn Adapter Inverse Adapter Flat Teeth Inverse		FZAI 72 Flachzahn Adapter Inverse Adapter Flat Teeth Inverse
	126031		126036
	FZ 72-L Flachzahn Flat Teeth		FZ 72 Flachzahn Flat Teeth
	126027		FZ 72-L-TF Flachzahn ohne Tungsten Flat Teeth Tungsten-Free
	FZ 72 Flachzahn Flat Teeth		

# Verschleißteile Bohrwerkzeuge – Bohrstrang

## Wear Parts Drilling Tools – Drill String

Darstellung Illustration	Bauer-Best.Nr. Bauer Item No.	Darstellung Illustration	Bauer-Best.Nr. Bauer Item No.
	Bezeichnung Description		Bezeichnung Description
	88832		86854
	FZ 80 Flachzahn Flat Teeth		FZ 80-TF Flachzahn ohne Tungsten Flat Teeth Tungsten-Free
 	205047		86855
	FZ 64 Flachzahn Flat Teeth		FZH 80 Flachzahnhalter Holder Flat Teeth
 	205044		55599
	FZH 64 Flachzahnhalter Holder Flat Teeth		FZH SB 80 Flachzahnhalter Sicherungsbügel Holder Safety Bow Flat Teeth
	21076		203120
	Pin FZ 64		Schraube Sicherungsbügel Flachzahn 80 Screw Safety Bow Flat Teeth



## **Dritoc – Erster Bohrwerkzeugkonfigurator weltweit** *Dritoc – First Drilling Tool Configurator worldwide*

- Online-Konfigurator, rund um die Uhr verfügbar (24/7)
- Beratungstool für Standard-Bohrwerkzeuge
- Anlaufstelle für unsere Kunden und auch für Neukunden
- Kostenlose Beratung für Kollegen und Kunden
- Plattform zum direkten Auffinden aller eingebauten und alternativen Verschleißteile und Zubehörteile
- *Online configurator available around the clock (24/7)*
- *Consultant for standard drilling tools*
- *Contact point for our customer and also for new customers*
- *Free advice for colleagues and customers*
- *Platform to find all fitted wear parts and accessories directly*

### Ihre Vorteile:

- **Einfache und schnelle** Konfiguration Ihrer Projekte
- **Jederzeit** die richtige Bohrwerkzeug-Empfehlung für jede Bodenschicht erhalten
- **Visualisierung** der Bohrwerkzeug-Empfehlung inkl. Verschleißteile und Zubehör für jede Bodenschicht
- **Verschleißteile-Empfehlung** für ausgewählte Bohrwerkzeuge

### Advantages:

- **Easy and fast** configuration of your projects
- **Get the right drilling tool recommendation for each soil layer at any time**
- **Visualization** of the drilling tool recommendation per soil layer
- **Wear parts recommendation** for selected drilling tools

# Verschleißteile Bohrwerkzeuge – Bohrstrang

## Wear Parts Drilling Tools – Drill String

### Rundschaftmeißel | Round Shank Chisel

<b>Kurzbezeichnung</b> Short Description	<b>RSM</b>	<b>D</b>	<b>17 x 30</b>	<b>HF</b>		
<b>Langbezeichnung</b> Long Description	<b>RSM</b>	<b>38 - 50</b>	<b>HF</b>	<b>17 x 30</b>	<b>131</b>	<b>CL</b>
	∅ Schaft ∅ Shaft	∅ Bund ∅ Body	∅ Hartmetall ∅ Tungsten	Länge Hartmetall Length Tungsten	Gesamtlänge Zahn Total Length Tooth	

#### Optionale Spezifikation | Optional Specification

**HF** mit Hartauftragring | with Hardfacing Ring  
**L** lange Version | Long Version  
**S** kurze Version | Short Version  
**TF** ohne Hartmetall | Tungsten-Free  
**P** spezielle Form | specific form

#### Befestigungsart | Fixing Method

**CL** Spannhülse lang | Clamping Sleeve Long  
**CS** Spannhülse kurz | Clamping Sleeve Short  
**SR** Sicherungsring | Snap Ring

#### Kürzel für Kombination Schaft und Bund | Short Term for Combination Shaft and Body

A	B	C	D	E	F	G	I	J
47-65	38-60	38-59	38-50	38-38	30-45	25-38	25-33	22-38
K	L	M	N	R	S	T		
19,4-38	19,4-27	18,7-27	13,9-20	12,9-20	11,3-20	11,3-17,5		

#### Rundschaftmeißel RSM-D und RSM-F | Round Shank Chisel

Darstellung Illustration	Bauer-Best.Nr. Bauer Item No.	Bezeichnung Description	Darstellung Illustration	Bauer-Best.Nr. Bauer Item No.	Bezeichnung Description
	205421	RSM-D 17x30 RSM-38-50-17x30-131-CL		849635	RSM-D 17x22 RSM 38-50-17x22-131-CL
	1137888	RSM-D 17x30-HF RSM 38-50-HF-17x30-131-CL		1148171	RSM-D 17x22-HF RSM 38-50-HF-17x22-131-CL
	205420	RSM-D 22x34 RSM 38-50-22x34-131-CL		795800	RSM-D 22x27 RSM 38-50-22x27-131-CL

# Verschleißteile Bohrwerkzeuge – Bohrstrang













## Wear Parts Drilling Tools – Drill String



Darstellung Illustration	Bauer-Best.Nr. Bauer Item No.	Darstellung Illustration	Bauer-Best.Nr. Bauer Item No.
	Bezeichnung Description		Bezeichnung Description
	909219		1035233
	RSM-D 22x34-HF RSM 38-50-HF-22x34-131-CL		RSM-D 22x27-HF RSM 38-50-HF-22x27-131-CL
	1190906		104968
	RSM-D 17x26-HF-P RSM 38-50-HF-T-17x26-131-CL		RSMH 38 mit Hartmetall with Tungsten
	205386		471506
	RSMH 38-TF-AS ohne Hartmetall aufschweißbar Tungsten-Free, Weld-on Version		RSMH 38-TF ohne Hartmetall Tungsten-Free
	390622		163601
	RSM-F 13x25 RSM 30-45-13x25-118-CS		RSMH 30-TF ohne Hartmetall Tungsten-Free

# Verschleißteile Bohrwerkzeuge – Bohrstrang

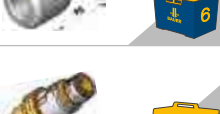
## Wear Parts Drilling Tools – Drill String

Rundschaftmeißel RSM-A   Round Shank Chisel				
Darstellung Illustration	Bauer-Best.Nr. Bauer Item No.	Bezeichnung Description		
	129131	RSM-A 25x30	RSM 47-65-25x30-152-CS	
	129132	RSMH 47-TF	ohne Hartmetall   <a href="#">Tungsten-Free</a>	
Rundschaftmeißel RSM-B   Round Shank Chisel				
	1035231	RSM-B 30x30	RSM 38-60-30x30-124-CL	
	104968	RSMH 38	mit Hartmetall   <a href="#">with Tungsten</a>	
	471506	RSMH 38-TF	ohne Hartmetall   <a href="#">Tungsten-Free</a>	
Rundschaftmeißel Zusatz RSM-D   Round Shank Chisel Additional				
	1271292	RSM-D 17x26-A	RSM 38-50-17x26-125-CL-LC-A	
	912684	RSM-D 17x28	RSM 38-50-17x28-125-CL	
	372442	RSM-D 19x29	RSM 38-50-19x29-125-CL	
	671866	RSM-D 19x29-L	RSM 38-50-19x29-140-CL	
	1035234	RSM-D 30x28	RSM 38-50-30x28-130-CL	
	104968	RSMH 38	mit Hartmetall   <a href="#">with Tungsten</a>	
	1320515	RSM-D 17x30 2x Klippring	RSM 38-50-17x30-130-CL-CS 2x Klippring   <a href="#">2x Clip Ring</a>	
	1320374	RSMH 38-G	mit Hartmetall und zusätzlicher Nut <a href="#">with Tungsten and additional groove</a>	

# Verschleißteile Bohrwerkzeuge – Bohrstrang











## Wear Parts Drilling Tools – Drill String



Rundschaftmeißel RSM-E   Round Shank Chisel				
Darstellung Illustration	Bauer-Best.Nr. Bauer Item No.	Bezeichnung Description		
	1035235	RSM-E 19x25	RSM 38-38-19x25-140-SR	
	1035236	RSM-E 19x25-L	RSM 38-38-19x25-163-SR	
	373989	RSMH 38-TF-SR	ohne Hartmetall   <a href="#">Tungsten-Free</a>	
Rundschaftmeißel RSM-G   Round Shank Chisel				
	728339	RSM-G 15x24	RSM 25-38-15x24-122-CS	
	739285	RSM-G 17x28	RSM 25-38-17x28-124-CS	
	239371	RSMH 25-TF	ohne Hartmetall   <a href="#">Tungsten-Free</a>	
Rundschaftmeißel RSM-I   Round Shank Chisel				
	1035237	RSM-I 9x18	RSM 25-33-09x18-121-CS	
	372443	RSM-I 12x19	RSM 25-33-12x19-118-CS	
	239371	RSMH 25-TF	ohne Hartmetall   <a href="#">Tungsten-Free</a>	
Rundschaftmeißel RSM-K   Round Shank Chisel				
	1035238	RSM-K 12x19	RSM 19,4-38-12x19-087-CS	
	925549	RSMH 19,4-TF-S	kurz, ohne Hartmetall   <a href="#">Short</a> , <a href="#">Tungsten-Free</a>	
	205387	RSMH 19,4-TF-L	lang, ohne Hartmetall   <a href="#">Long</a> , <a href="#">Tungsten-Free</a>	
	1324008	RSM-J 12x22	RSM 22-38-12x22-98,6-CL	

# Verschleißteile Bohrwerkzeuge – Bohrstrang

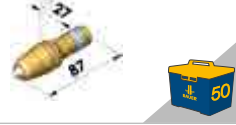









## Wear Parts Drilling Tools – Drill String

Rundschaftmeißel RSM-L   Round Shank Chisel				
Darstellung Illustration	Bauer-Best.Nr. Bauer Item No.	Bezeichnung Description		
	1035239	RSM-L 9x18	RSM 19,4-27-09x18,5-084-CS	
	876535	RSM-L 11x22	RSM 19,4-27-11x22-084-CS	
	205388	RSM-L 12x19	RSM 19,4-27-12x19-084-CS	
	1059203	RSM-L 12x19-L	RSM 19,4-27-12x19-086-CL	
	925549	RSMH 19,4-TF-S	kurz, ohne Hartmetall   <a href="#">Short, Tungsten-Free</a>	
	205387	RSMH 19,4-TF-L	lang, ohne Hartmetall   <a href="#">Long, Tungsten-Free</a>	
Rundschaftmeißel RSM-M   Round Shank Chisel				
	876534	RSM-M 8x15	RSM 18,7-27-08x15-085-CS	
	1035240	RSM-M 8x16	RSM 18,7-27-08x16,4-091-CS	
	768594	RSM-M 12x19	RSM 18,7-27-12x19-087-CS	
	726624	RSM-M 16x13	RSM 18,7-27-16x13,3-085-CS	
	932034	RSMH 18,7-TF	ohne Hartmetall   <a href="#">Tungsten-Free</a>	

# Verschleißteile Bohrwerkzeuge – Bohrstrang

## Wear Parts Drilling Tools – Drill String









Rundschaftmeißel RSM-N   Round Shank Chisel				
Darstellung Illustration	Bauer-Best.Nr. Bauer Item No.	Bezeichnung Description		
	392321	RSM-N 16x13	RSM 13,9-20-16x13,3-054-CL	
	1035251	RSM-N 16x16	RSM 13,9-20-16x16-054-CL	
	392336	RSMH 13,9-TF	ohne Hartmetall   <a href="#">Tungsten-Free</a>	
Rundschaftmeißel RSM-R   Round Shank Chisel				
	1035252	RSM-R 8x16	RSM 12,9-20-08x16,4-055-CL	
	1035253	RSM-R 16x13	RSM 12,9-20-16x13,3-055-CL	
	1037259	RSMH 12,9-TF	ohne Hartmetall   <a href="#">Tungsten-Free</a>	
Rundschaftmeißel RSM-S   Round Shank Chisel				
	876311	RSM-S 16x13	RSM 11,3-20-16x13,3-051-SR	
	1035254	RSM-S 16x16	RSM 11,3-20-16x16-053-SR	
	680435	RSMH 11,3-TF	ohne Hartmetall   <a href="#">Tungsten-Free</a>	
Rundschaftmeißel RSM-T   Round Shank Chisel				
	387593	RSM-T 8x16	RSM 11,3-17,5-8x16,4-053-SR	
	680435	RSMH 11,3-TF	ohne Hartmetall   <a href="#">Tungsten-Free</a>	

# Verschleißteile Bohrwerkzeuge – Bohrstrang

## Wear Parts Drilling Tools – Drill String

### Rollenmeißel | Roller Bits

Rollenmeißel und Zubehör für Rollenmeißelkernbohrrohr KR-RM-HF, neue Version Roller Bits and Accessories for Roller Bit Core Barrel KR-RM-HF, New Version					
Darstellung Illustration	Bauer-Best.Nr. Bauer Item No.	Bezeichnung Description	Darstellung Illustration	Bauer-Best.Nr. Bauer Item No.	Bezeichnung Description
	1208345	Rollenmeißel kpl. 8 1/2", 114 Typ A-I Roller Bit		1208344	Rollenmeißel, Tiefenbegrenzer RM-TB 114 Roller Bit Depth Limiter
	1208346	Rollenmeißel kpl. 8 1/2", 114 Typ A-II Roller Bit		1285984	Wechselleiste Replaceable Ledge
	1208347	Rollenmeißel kpl. 8 1/2", 114 Typ A-III Roller Bit		18110	Spannstift leicht 12 x 50 Spring Pin Light

Die angegebenen Bauer-IDs der oben genannten Komponenten sind Komplettstücklisten, d. h. die Komponenten werden mit Schrauben, Muttern und Buchsen ausgeliefert. Auf Anfrage können auch einzelne Teile angeboten werden.

Als Ergebnis mehrerer Testreihen wurde unsere A-Serie der Rollenmeißel (für sehr harte Bodenverhältnisse) als Standardbestückung unserer Rollenmeißelkernrohre definiert. Weitere Typen sind auf Anfrage erhältlich.

The Bauer-IDs of the above mentioned components are entire parts lists, which means those components come with screws, nuts and bushes. On request we will offer single parts as well.

As a result of multiple tests our A-series of the roller bits (for very hard soil conditions) got defined as the standard set for our roller bit core barrels. Further types are available on request.



# Verschleißteile Bohrwerkzeuge – Bohrstrang

## Wear Parts Drilling Tools – Drill String

### Verschleißwinkel/-leisten | Wear Angles/Wear Strips

Darstellung Illustration	Bauer-Best.Nr. Bauer Item No.	Darstellung Illustration	Bauer-Best.Nr. Bauer Item No.
	Bezeichnung Description		Bezeichnung Description
	120927		370172
	VW 30 x 26 x 70-13 Verschleißwinkel Vermerk: für Schnecken- bohrer Wear Angle Note: for Auger		VL 100 x 50-10 Verschleißleiste Vermerk: für Kastenbohrer Wear Strip Note: for Drilling Buckets
	120926		362435
	VW 50 x 26 x 70-13 Verschleißwinkel Vermerk: für Drehböden Wear Angle Note: for Turn Bottoms		VL 150 x 50-10 Verschleißleiste Vermerk: für Anfänger Wear Strip Note: for Starter Bits
			620170
			VL 1000 x 50-10 Verschleißleiste Wear Strip









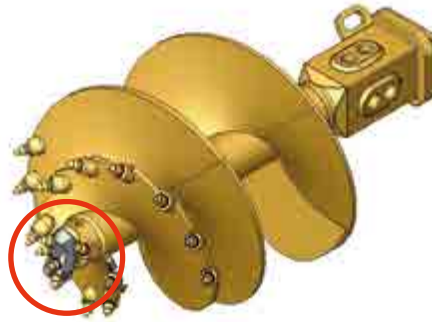

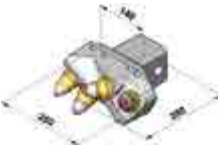

# Verschleißteile Bohrwerkzeuge – Bohrstrang

## Wear Parts Drilling Tools – Drill String

### Piloten | Pilot Bits



Darstellung Illustration	Bauer-Best.Nr. Bauer Item No.	Bezeichnung Description	Darstellung Illustration	Bauer-Best.Nr. Bauer Item No.	Bezeichnung Description
	121027	Rundschaftmeißel- pilot 4 rechteckig Pilot Round Shank Chisel 4 Rectangulare		205075	Wendepilot Fish Tail Pilot
	1131774	Rundschaftmeißel- pilot 4 kpl. mit Austreibbohrungen Pilot Round Shank Chisel 4 cpl. with Tooth Extractor Holes		101991	Absteckbolzen 175 Pilot Pin
	390644	Rundschaftmeißel- pilot 4 quadratisch Pilot Round Shank Chisel 4 Square		101992	Absteckbolzen 200 Pilot Pin
	1026754	Rundschaftmeißel- pilot 3 quadratisch Pilot Round Shank Chisel 3 Square		205527	Pilotaufnahme 177 Pilot Box
	390216	Pilot ohne Zentrum Centreless Pilot		101881	Pilotaufnahme 200 Pilot Box

# Wechselwerkzeuge

## Exchanging Tools



### Montagevorrichtung für WS-Stollen/Stifte | Mounting Device for WS-Teeth/Pins



Kennen Sie die Herausforderung:  
Es müssen auf der Baustelle oder im  
Workshop Wechselstollen getauscht  
werden und man bräuchte eigentlich  
drei Hände dafür?

Have you had the issue of “not enough  
hands” when changing WS Teeth?



Die neue Montagevorrichtung macht  
das Austauschen von Wechselstollen  
einfacher, schneller und sicherer.

Our new mounting device can assist  
you, making the task safer, faster  
and easier.



Dazu legen wir den neuen Zahn in  
die Montagevorrichtung (passend  
für alle WS 39, 46 und 52).

We secure the device and place the  
WS tooth (suitable for all types of  
WS 39 / 46 / 52).

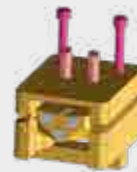

Wir klappen die Führung herunter  
und legen die Stifte ein.

We lower the guide and place the  
pins in the device.



Wir schlagen die Stifte mit dem  
Hammer bis zum Anschlag.

We hammer the pins until mechani-  
cal stop.



Die Stifte sind nun perfekt im Wech-  
selstollen fixiert.

The pins are now perfectly fixed to  
the WS tooth.



Wir entnehmen den Zahn und  
können ihn nun wieder problemlos  
einbauen.

Remove the WS tooth, which is  
now ready to install.









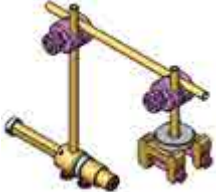

**Bauer-ID: 1187990**

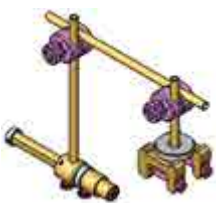
**Montagevorrichtung für WS-Stollen/Stifte**  
Mounting Device for WS-Teeth/Pins







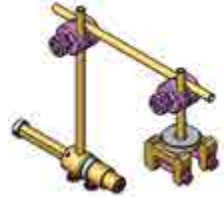

# Wechselwerkzeuge

## Exchanging Tools





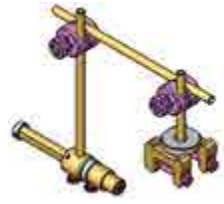



Reparaturvorrichtung   Repair Device			
Verwendung Usage	Bauer-Best.Nr. Bauer Item No.	Bauer-Best.Nr. Bauer Item No.	Bauer-Best.Nr. Bauer Item No.
	Darstellung und Bezeichnung Illustration and Description	Darstellung und Bezeichnung Illustration and Description	Darstellung und Bezeichnung Illustration and Description
 <p>Rundschaftmeißelhalter RSMH 38 Holder Round Shank Chisel</p>	<p>429943</p>  <p>Reparaturvorrichtung Repair Device</p>	-	-
 <p>Flachzahnhalter FZHI 54 Inverse Holder Flat Teeth</p>	<p>429943</p>  <p>Reparaturvorrichtung Repair Device</p>	<p>674026</p>  <p>Reparaturvorrichtung Dorn RV-D FZ 54 Mandrel Repair Device</p>	-
 <p>Flachzahnhalter FZH 54 Holder Flat Teeth</p>	<p>429943</p>  <p>Reparaturvorrichtung Repair Device</p>	<p>674026</p>  <p>Reparaturvorrichtung Dorn RV-D FZ 54 Mandrel Repair Device</p>	<p>645567</p>  <p>Flachzahnadapter FZAI 54 Inverse Adapter Flat Teeth</p>

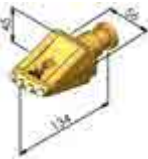

# Wechselwerkzeuge Exchanging Tools

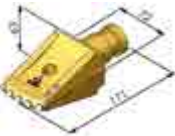
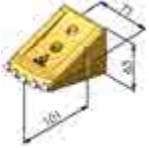



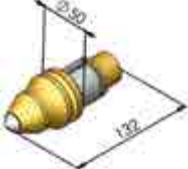
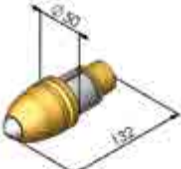



Verwendung Usage	Bauer-Best.Nr. Bauer Item No.  Darstellung und Bezeichnung Illustration and Description	Bauer-Best.Nr. Bauer Item No.  Darstellung und Bezeichnung Illustration and Description	Bauer-Best.Nr. Bauer Item No.  Darstellung und Bezeichnung Illustration and Description
 <p>Flachzahnhalter FZHI 72 Inverse Holder Flat Teeth</p>	<p>429943</p>  <p>Reparaturvorrichtung Repair Device</p>	<p>674024</p>  <p>Reparaturvorrichtung Dorn RV-D FZ 72 Mandrel Repair Device</p>	<p>-</p>
 <p>Flachzahnhalter FZH 72 Holder Flat Teeth</p>	<p>429943</p>  <p>Reparaturvorrichtung Repair Device</p>	<p>674024</p>  <p>Reparaturvorrichtung Dorn RV-D FZ 72 Mandrel Repair Device</p>	<p>645444</p>  <p>Flachzahnadapter FZAI 72 Inverse Adapter Flat Teeth</p>
 <p>Wechselstollen Halter WSH 39 - 52 Holder Replaceable Teeth</p>	<p>429943</p>  <p>Reparaturvorrichtung Repair Device</p>	<p>1104978</p>  <p>Reparaturvorrichtung Dorn für WS-Halter Mandrel Repair Device for WS Holder</p>	<p>-</p>

# Wechselwerkzeuge Exchanging Tools

Schlagabzieher   Impact Extraction Tool				
381355 Schlagabzieher Impact Extractor Tool	Bauer-Best.Nr. Bauer Item No.	Aufsatz Schlagabzieher Top Piece Impact Extractor Tool	Verwendung Usage	
	Bezeichnung Description			
	161881		FZ 54	FZ 54 Inverse
	Wechselwerkzeug- aufsatz FZ 54 Exchanging Tool Attachment			
	373094		FZ 72	FZ 72 Inverse
	Wechselwerkzeug- aufsatz FZ 72 Exchanging Tool Attachment			
	381427		Rundschaftmeißel RSM-C Round Shank Chisel	
	Wechselwerkzeug- aufsatz RSM-C Exchanging Tool Attachment			
124345		Rundschaftmeißel RSM-D Round Shank Chisel		
Wechselwerkzeug- aufsatz RSM-D Exchanging Tool Attachment				

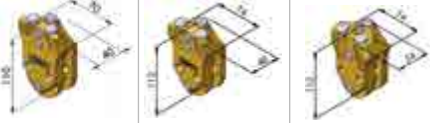



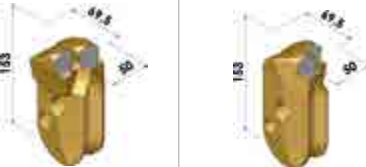







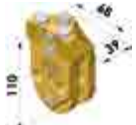





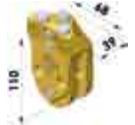



# Wechselwerkzeuge Exchanging Tools



381355 Schlagabzieher Impact Extractor Tool	Bauer-Best.Nr. Bauer Item No.	Aufsatz Schlagabzieher Top Piece Impact Extractor Tool	Verwendung Usage
Bezeichnung Description			
	114928		Rundschaftmeißel RSM-F Round Shank Chisel
	Wechselwerkzeug- aufsatz RSM-F Exchanging Tool Attachment		
	381356		Wechselstollen WS 39/46/52 Replaceable Teeth
	Wechselwerkzeug- aufsatz WS 39-52 Exchanging Tool Attachment		
	779037		Standard Fräszähne BFZ Standard Cutter Teeth
	Wechselwerkzeug- aufsatz BFZ Exchanging Tool Attachment		
1339256		Standard Fräszähne BFZ Standard Cutter Teeth	
Wechselwerkzeug- aufsatz BFZ T2 Exchanging Tool Attachment			

# Wechselwerkzeuge

## Exchanging Tools

Ein- und Austreibwerkzeuge   Insertion and Extraction Tools				
Darstellung Illustration	Bauer-Best.Nr. Bauer Item No.	Verwendung Usage		
	Bezeichnung Description			
	673994	FZ Inverse 54/72	WS 39/46/52	
	Austreiber F12 mit Handschutz <a href="#">Pin Extractor with Hand Guard</a>			
	674039	FZ Inverse 54/72	WS 39/46/52	
	Austreiber F12 flexibel <a href="#">Pin Extractor Flexible</a>			
	680952	FZ Inverse 54/72	WS 39/46/52	Stand. Fräszähne <a href="#">Std. Cutter Teeth</a>
	Bolzentreiber F12 <a href="#">Pin Driver</a>			
	1331854			
		681144	FZ Inverse 54/72	WS 39/46/52
Pneumatik-Hammer <a href="#">Pneumatic Hammer Drill</a>				
	1255437	für den Betrieb am Pneumatikhammer <a href="#">for Pneumatic Hammer Drill</a>		
	Speed-Pinner WS mit Schaft, rund <a href="#">Speed-Pinner</a>			
	1331748	für den Betrieb am Akku-Bohrhammer <a href="#">for Rechargeable Hammer Drill</a>		
	Speed-Pinner WS mit Schaft, SDS-plus <a href="#">Speed-Pinner</a>			
	508998	Gliederbänder   <a href="#">Link Conveyor</a> Ø 368/470 mm		
	Gliederband 368/470 <a href="#">Wedge Chain</a>			
	92125	WS 20		
	Splinttreiber 6 mm <a href="#">Pin Punch</a>			



## Speed-Pinner

Was unseren neuen Speed-Pinner besonders macht:













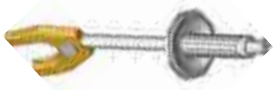

- Schneller und einfacher Austausch der Wechselstollen
- Garantierte Einschlagtiefe der Spannstifte
- Keine „drei Hände“ für die Montage erforderlich
- Sichere Anwendung – keine Quetschgefahr, da Finger/Hände außerhalb des Arbeitsbereichs
- Gleiche Montagevorrichtung für beide Einbaurichtungen des Wechselstollen
- Zum Auspinnen ist der Bolzentreiber einfach ohne Montageaufwand aus dem Speed-Pinner herausnehmbar

*What are the specials of our new Speed-Pinner:*

- *Fast exchange of the replaceable teeth*
- *Guaranteed mounting depth of the pin*
- *No “three hands” for replacement necessary*
- *Safe application – no risk of crushing hazards because fingers and hands are outside of the working area*
- *Same mounting device for both mounting directions of the replaceable teeth*
- *To remove the pin the pin driver gets easily pulled out of the Speed-Pinner*

# Wechselwerkzeuge

## Exchanging Tools



Darstellung Illustration	Bauer-Best.Nr. Bauer Item No.	Verwendung Usage	
	Bezeichnung Description		
	1133303	Rundschaftmeißelpilot 4 kpl. mit Austreibbohrungen  Pilot Round Shank Chisel 4 cpl. with Tooth Extractor Holes	
	Meißelaustreiber RSM-D Bit Extractor		
	113511	-	
	Austreibdorn für RSM 113 Mandrel		
	247149	Rundschaftmeißel RSM-D Round Shank Chisel	
	Ausziehgabel RSM-D Extraction Fork		
	1054527	Rundschaftmeißel RSM F Round Shank Chisel	
	Ausziehgabel mit Kupferscheibe Extraction Fork with Copper Washer		
	789307	Rundschaftmeißel RSM F Round Shank Chisel	
	Ausziehgabel RSM-F Extraction Fork		
	138471	Standard Fräszähne Standard Cutter Teeth	
	Austreiber F16 mit Handschutz Pin Extractor with Hand Guard		
	138463	Standard Fräszähne Standard Cutter Teeth	
	Austreiber F16 flexibel Pin Extractor Flexible		
	1100195		
	Kupferhammer Copper Hammer		
	1415754		
	Leichtmetallhammer Light Metal Hammer		
	1400971		
	Werkzeugkoffer - Bohrwerkzeug Tool Box - Drilling Tools		



# Ersatzteile Rohrstrang

## Spare Parts Casing String

### Rohrverbinder | Casing Joints



Darstellung Illustration	Bauer-Best.Nr. Bauer Item No.	Bezeichnung Description	Ø Bohrröhr (mm) Ø Casing (mm)	Anzahl Gewindinge Quantity Thread Rings
	70479	Rohrkragen Mutterteil Casing Joint Female	620	8
	70478		750	10
	70477		880	10
	70476		1000	10
	70474		1180	12
	70473		1300	12
	70472		1500	12
	70471		1800	16
	236451		2000	18
	470252		2200	18
	236452		2500	24
	70470	Rohrkragen Vaterteil Casing Joint Male	620	8
	70469		750	10
	70468		880	10
	70467		1000	10
	70465		1180	12
	70464		1300	12
	70463		1500	12
	70462		1800	16
	236418		2000	18
	470197		2200	18
	236455		2500	24

Auf Anfrage sind Schneidringe in weiteren Durchmessern erhältlich.  
On request further diameters of cutting rings are available.

# Ersatzteile Rohrstrang

## Spare Parts Casing String

### Schneidringe Rohrschuhe | Cutting Rings Casing Shoes



Darstellung Illustration	Bauer-Best.Nr. Bauer Item No.	Bezeichnung Description	Ø Schneidring (mm) Ø Cutting Ring (mm)	Anzahl Zähne Quantity Teeth
<b>Schneidring RS-WS 20   Cutting Ring</b>				
	463068	Schneidring RS-WS Cutting Ring	305	8
	463069		406	8
	463070		508	10
	463071		610	10
	723311		750	10
	463072		813	12
	658222		880	12
	658223		1000	12
<b>Schneidring RS-WS 39   Cutting Ring</b>				
	407474	Schneidring RS-WS Cutting Ring	620	12
	407450		750	16
	742395		800	18
	407446		880	18
	742396		900	18
	407441		1000	18
	990901		1080	18
	406606		1180	20
	813144		1200	20
	407437		1300	24
	407433		1350	24
	<b>Schneidring 360°   Cutting Ring</b>			
	1140549	Schneidring RS-WS-E Cutting Ring	620	9
	1140552		750	9
	1115850		880	12
	1140557		900	12
	1140466		1000	12
	1136563		1180	15
	1140569		1300	18

Auf Anfrage sind Schneidringe in weiteren Durchmessern erhältlich.  
On request further diameters of cutting rings are available.



# Ersatzteile Rohrstrang



## Spare Parts Casing String

Darstellung Illustration	Bauer-Best.Nr. Bauer Item No.	Bezeichnung Description	Ø Schneidring (mm) Ø Cutting Ring (mm)	Anzahl Zähne Quantity Teeth
Schneidring RS-WS 46   <a href="#">Cutting Ring</a>				
	404415	Schneidring RS-WS Cutting Ring	1500	30
	671251		1650	30
	509238		1800	36
Schneidring RS-WS 52   <a href="#">Cutting Ring</a>				
	670043	Schneidring RS-WS Cutting Ring	2000	36
	670044		2200	36
	670045		2500	36
Schneidring RS-BR (AS 35 x 91 x 48-5)   <a href="#">Cutting Ring</a>				
	386444	Schneidring RS-BR Cutting Ring	620	16
	386445		750	16
	386446		880	18
	394643		900	18
	386447		1000	18
	386448		1180	20
	260490		1200	20
	386449		1300	24

Auf Anfrage sind Schneidringe in weiteren Durchmessern erhältlich.  
On request further diameters of cutting rings are available.

# Ersatzteile Rohrstrang

## Spare Parts Casing String

Darstellung Illustration	Bauer-Best.Nr. Bauer Item No.	Bezeichnung Description	Ø Schneidring (mm) Ø Cutting Ring (mm)	Anzahl Zähne Quantity Teeth
Schneidring RS-AS 43 (AS 43 x 95 x 65-7)   <a href="#">Cutting Ring</a>				
	101859	Schneidring RS-BR <a href="#">Cutting Ring</a>	1500	30
	247528		1650	30
	226319		1800	36
Schneidring RS-AZ 32 (AZ 32 x 90 x 67-4)   <a href="#">Cutting Ring</a>				
	226326	Schneidring RS-BH <a href="#">Cutting Ring</a>	620	16
	226347		750	16
	101867		880	18
	226348		1000	18
	226349		1180	20
	226350		1300	24
	101869		1500	30
	226351		1800	36
Schneidring RS-AS 22 (AS 22 x 55 x 43-4)   <a href="#">Cutting Ring</a>				
	104417	Schneidring RS-AS <a href="#">Cutting Ring</a>	305	8
	241318		406	10
	229481		508	12
	230013		610	12
	374937		815	16



Auf Anfrage sind Schneidringe in weiteren Durchmessern erhältlich.  
On request further diameters of cutting rings are available.



# Ersatzteile Bohrwerkzeuge

## Spare Parts Drilling Tools



### Schneidringe Kernrohr | Cutting Rings Core Barrel

Darstellung Illustration	Bauer-Best.Nr. Bauer Item No.	Bezeichnung Description	Ø Kernrohr (mm) Ø Core Barrel (mm)	Anzahl Zähne Quantity Teeth
Schneidring KR-R (RSM-D 17 x 30)   <a href="#">Cutting Ring</a>				
	377930	Schneidring KR-R <a href="#">Cutting Ring</a>	520	6
	377976		650	7
	377979		780	9
	377980		900	11
	377982		1060	11
	378023		1180	15
	378026		1350	15
	378028		1500	15
	378029		1650	15
	378030		1830	15
Schneidring KR-AS (AS 27 x 52 x 49-5)   <a href="#">Cutting Ring</a>				
	205464	Schneidring KR-AS <a href="#">Cutting Ring</a>	520	12
	205465		650	14
	205467		900	26
	205469		1060	32
	205471		1350	40
	205472		1500	32
	228664		1650	49
	210355		1830	55

Auf Anfrage sind Schneidringe in weiteren Durchmessern erhältlich.  
On request further diameters of cutting rings are available.

# Ersatzteile Bohrwerkzeuge

## Spare Parts Drilling Tools



Darstellung Illustration	Bauer-Best.Nr. Bauer Item No.	Bezeichnung Description	Ø Kernrohr (mm) Ø Core Barrel (mm)	Anzahl Zähne Quantity Teeth
Schneidring KR-AS (AS 38 x 70 x 47-7)   <a href="#">Cutting Ring</a>				
	474459	Schneidring KR-AS <a href="#">Cutting Ring</a>	780	12
	474462		1180	20
Schneidring KR-S (Bohrspitze 15 x 20)   <a href="#">Cutting Ring (Drill Bit 15 x 20)</a>				
	205488	Schneidring KR-S <a href="#">Cutting Ring</a>	520	32
	205489		650	32
	205490		780	40
	205491		900	46
	205493		1060	54
	205494		1200	60
	205495		1350	68
	205496		1500	76
	52030		1650	84
	228861		1800	90

Auf Anfrage sind Schneidringe in weiteren Durchmessern erhältlich.  
On request further diameters of cutting rings are available.



# Ersatzteile Bohrwerkzeuge

## Spare Parts Drilling Tools



Darstellung Illustration	Bauer-Best.Nr. Bauer Item No.	Bezeichnung Description	Ø Kernrohr (mm) Ø Core Barrel (mm)	Anzahl Zähne Quantity Teeth
Schneidring KR-WS (WS 46)   <a href="#">Cutting Ring</a>				
	461458	Schneidring KR-WS <a href="#">Cutting Ring</a>	520	9
	461459		650	9
	461457		780	12
	461460		900	12
	461461		1060	15
	461462		1180	18
	461463		1350	21
	461464		1500	24
	505026		1520	24
Schneidring KS-R (RSM-D 17 x 30)   <a href="#">Cutting Ring</a>				
	420938	Schneidring KS-R <a href="#">Cutting Ring</a>	780	11
	472999		900	13
	477175		1060	15
	409052		1180	17
	477176		1350	19
	163573		1500	22
	416740		1650	23
	616655		1850	25
	603189		1970	26
	786818		2100	28
	786819		2250	30
	764987		2500	33

Auf Anfrage sind Schneidringe in weiteren Durchmessern erhältlich.  
On request further diameters of cutting rings are available.

# Ersatzteile Bohrwerkzeuge

## Spare Parts Drilling Tools



### Drehböden für Kastenbohrer | Turn Bottoms for Drilling Buckets

Darstellung Illustration	Bauer-Best.Nr. Bauer Item No.	Bezeichnung Description	Ø Drehboden (mm) Ø Turn Bottom (mm)
Drehboden: KB FZ Inverse   <a href="#">Turn Bottom</a>			
	799200	Drehboden kpl. 520 KB   <a href="#">Turn Bottom cpl.</a>	520
	799202	Drehboden kpl. 650 KB   <a href="#">Turn Bottom cpl.</a>	650
	799203	Drehboden kpl. 780 KB   <a href="#">Turn Bottom cpl.</a>	780
	799205	Drehboden kpl. 900 KB   <a href="#">Turn Bottom cpl.</a>	900
	799206	Drehboden kpl. 1000 KB   <a href="#">Turn Bottom cpl.</a>	1000
	799207	Drehboden kpl. 1060 KB   <a href="#">Turn Bottom cpl.</a>	1060
	799218	Drehboden kpl. 1180 KB   <a href="#">Turn Bottom cpl.</a>	1180
	799221	Drehboden kpl. 1350 KB   <a href="#">Turn Bottom cpl.</a>	1350
	799222	Drehboden kpl. 1500 KB   <a href="#">Turn Bottom cpl.</a>	1500
	799223	Drehboden kpl. 1650 KB   <a href="#">Turn Bottom cpl.</a>	1650
Drehboden: KB   <a href="#">Turn Bottom</a>			
	371988	Drehboden kpl. 520 KB   <a href="#">Turn Bottom cpl.</a>	520
	372088	Drehboden kpl. 650 KB   <a href="#">Turn Bottom cpl.</a>	650
	372090	Drehboden kpl. 780 KB   <a href="#">Turn Bottom cpl.</a>	780
	372122	Drehboden kpl. 1000 KB   <a href="#">Turn Bottom cpl.</a>	1000
	372104	Drehboden kpl. 1060 KB   <a href="#">Turn Bottom cpl.</a>	1060
	372110	Drehboden kpl. 1180 KB   <a href="#">Turn Bottom cpl.</a>	1180
	372108	Drehboden kpl. 1350 KB   <a href="#">Turn Bottom cpl.</a>	1350
	376530	Drehboden kpl. 1500 KB   <a href="#">Turn Bottom cpl.</a>	1500
Drehboden: KB-2 FZ Inverse   <a href="#">Turn Bottom</a>			
	817875	Drehboden kpl. 1060 KB-2   <a href="#">Turn Bottom cpl.</a>	1060
	817876	Drehboden kpl. 1180 KB-2   <a href="#">Turn Bottom cpl.</a>	1180
	817873	Drehboden kpl. 1350 KB-2   <a href="#">Turn Bottom cpl.</a>	1350
	817874	Drehboden kpl. 1500 KB-2   <a href="#">Turn Bottom cpl.</a>	1500
	817879	Drehboden kpl. 1650 KB-2   <a href="#">Turn Bottom cpl.</a>	1650
	817878	Drehboden kpl. 1830 KB-2   <a href="#">Turn Bottom cpl.</a>	1830

# Ersatzteile Bohrwerkzeuge



## Spare Parts Drilling Tools



Darstellung Illustration	Bauer-Best.Nr. Bauer Item No.	Bezeichnung Description	Ø Drehboden (mm) Ø Turn Bottom (mm)
Drehboden: KB 2   <a href="#">Turn Bottom</a>			
	374298	Drehboden kpl. 1350 KB-2   <a href="#">Turn Bottom cpl.</a>	1350
	381312	Drehboden kpl. 1500 KB-2   <a href="#">Turn Bottom cpl.</a>	1500
Drehboden: KB-K FZ Inverse   <a href="#">Turn Bottom</a>			
	799625	Drehboden kpl. 520 KB-K   <a href="#">Turn Bottom cpl.</a>	520
	799627	Drehboden kpl. 650 KB-K   <a href="#">Turn Bottom cpl.</a>	650
	799638	Drehboden kpl. 780 KB-K   <a href="#">Turn Bottom cpl.</a>	780
	799640	Drehboden kpl. 900 KB-K   <a href="#">Turn Bottom cpl.</a>	900
	799641	Drehboden kpl. 1000 KB-K   <a href="#">Turn Bottom cpl.</a>	1000
	799642	Drehboden kpl. 1060 KB-K   <a href="#">Turn Bottom cpl.</a>	1060
	799643	Drehboden kpl. 1180 KB-K   <a href="#">Turn Bottom cpl.</a>	1180
	799645	Drehboden kpl. 1350 KB-K   <a href="#">Turn Bottom cpl.</a>	1350
	799624	Drehboden kpl. 1500 KB-K   <a href="#">Turn Bottom cpl.</a>	1500
799647	Drehboden kpl. 1650 KB-K   <a href="#">Turn Bottom cpl.</a>	1650	
Drehboden: KB-K   <a href="#">Turn Bottom</a>			
	799625	Drehboden kpl. 520 KB-K   <a href="#">Turn Bottom cpl.</a>	520
	799627	Drehboden kpl. 650 KB-K   <a href="#">Turn Bottom cpl.</a>	650
	799638	Drehboden kpl. 780 KB-K   <a href="#">Turn Bottom cpl.</a>	780
	799640	Drehboden kpl. 900 KB-K   <a href="#">Turn Bottom cpl.</a>	900
	799641	Drehboden kpl. 1000 KB-K   <a href="#">Turn Bottom cpl.</a>	1000
	799642	Drehboden kpl. 1060 KB-K   <a href="#">Turn Bottom cpl.</a>	1060
	799643	Drehboden kpl. 1180 KB-K   <a href="#">Turn Bottom cpl.</a>	1180

# Ersatzteile Bohrwerkzeuge

## Spare Parts Drilling Tools

Darstellung Illustration	Bauer-Best.Nr. Bauer Item No.	Bezeichnung Description	Ø Drehboden (mm) Ø Turn Bottom (mm)
Drehboden: KB-K2 FZ Inverse   <a href="#">Turn Bottom</a>			
	817596	Drehboden kpl. 1060 KB-K2   <a href="#">Turn Bottom cpl.</a>	1060
	817597	Drehboden kpl. 1180 KB-K2   <a href="#">Turn Bottom cpl.</a>	1180
	817593	Drehboden kpl. 1350 KB-K2   <a href="#">Turn Bottom cpl.</a>	1350
	817594	Drehboden kpl. 1500 KB-K2   <a href="#">Turn Bottom cpl.</a>	1500
	817600	Drehboden kpl. 1650 KB-K2   <a href="#">Turn Bottom cpl.</a>	1650
	817599	Drehboden kpl. 1830 KB-K2   <a href="#">Turn Bottom cpl.</a>	1830
Drehboden: KB-K2   <a href="#">Turn Bottom</a>			
	391082	Drehboden kpl. 1180 KB-K2   <a href="#">Turn Bottom cpl.</a>	1180
	365799	Drehboden kpl. 1350 KB-K2   <a href="#">Turn Bottom cpl.</a>	1350
	392307	Drehboden kpl. 1500 KB-K2   <a href="#">Turn Bottom cpl.</a>	1500
Drehboden: KB-P FZ Inverse   <a href="#">Turn Bottom</a>			
	507923	Drehboden kpl. 780 KB-P   <a href="#">Turn Bottom cpl.</a>	780
	950130	Drehboden kpl. 900 KB-P   <a href="#">Turn Bottom cpl.</a>	900
	507924	Drehboden kpl. 1060 KB-P   <a href="#">Turn Bottom cpl.</a>	1060
	507922	Drehboden kpl. 1180 KB-P   <a href="#">Turn Bottom cpl.</a>	1180
	487150	Drehboden kpl. 1350 KB-P   <a href="#">Turn Bottom cpl.</a>	1350
	486659	Drehboden kpl. 1500 KB-P   <a href="#">Turn Bottom cpl.</a>	1500
	790217	Drehboden kpl. 1650 KB-P   <a href="#">Turn Bottom cpl.</a>	1650

# Ersatzteile Bohrwerkzeuge

## Spare Parts Drilling Tools





Darstellung Illustration	Bauer-Best.Nr. Bauer Item No.	Bezeichnung Description	Ø Drehboden (mm) Ø Turn Bottom (mm)
<b>Drehboden: KB-L   Turn Bottom</b>			
	246539	Drehboden kpl. 520 KB-L   <a href="#">Turn Bottom cpl.</a>	520
	246541	Drehboden kpl. 650 KB-L   <a href="#">Turn Bottom cpl.</a>	650
	246543	Drehboden kpl. 780 KB-L   <a href="#">Turn Bottom cpl.</a>	780
	246544	Drehboden kpl. 900 KB-L   <a href="#">Turn Bottom cpl.</a>	900
	246545	Drehboden kpl. 1000 KB-L   <a href="#">Turn Bottom cpl.</a>	1000
	246546	Drehboden kpl. 1060 KB-L   <a href="#">Turn Bottom cpl.</a>	1060
	246548	Drehboden kpl. 1350 KB-L   <a href="#">Turn Bottom cpl.</a>	1350
	137755	Drehboden kpl. 1500 KB-L   <a href="#">Turn Bottom cpl.</a>	1500
	139735	Drehboden kpl. 1680 KB-L   <a href="#">Turn Bottom cpl.</a>	1680
<b>Drehboden: KB-L2   Turn Bottom</b>			
	381329	Drehboden kpl. 1500 KB-L2   <a href="#">Turn Bottom cpl.</a>	1500
	390514	Drehboden kpl. 1680 KB-L2   <a href="#">Turn Bottom cpl.</a>	1680
<b>Drehboden: KB-WL*   Turn Bottom</b>			
	1092104	Drehboden kpl. 520 KB-WL   <a href="#">Turn Bottom cpl.</a>	520
	1092105	Drehboden kpl. 650 KB-WL   <a href="#">Turn Bottom cpl.</a>	650
	1092106	Drehboden kpl. 780 KB-WL   <a href="#">Turn Bottom cpl.</a>	780
	1092107	Drehboden kpl. 900 KB-WL   <a href="#">Turn Bottom cpl.</a>	900
	1092108	Drehboden kpl. 1060 KB-WL   <a href="#">Turn Bottom cpl.</a>	1060
	1092103	Drehboden kpl. 1180 KB-WL   <a href="#">Turn Bottom cpl.</a>	1180
	991490	Drehboden kpl. 1350 KB-WL   <a href="#">Turn Bottom cpl.</a>	1350
	991511	Drehboden kpl. 1500 KB-WL   <a href="#">Turn Bottom cpl.</a>	1500

\* Wechselleiste siehe Kapitel „Allg. Verschleißteile und Zubehör KB“

\* Replaceable Ledge on Section „General Consumables and Accessories KB“

# Ersatzteile Bohrwerkzeuge

## Spare Parts Drilling Tools

Darstellung Illustration	Bauer-Best.Nr. Bauer Item No.	Bezeichnung Description	Ø Drehboden (mm) Ø Turn Bottom (mm)
Drehboden: KB-WL2*   <a href="#">Turn Bottom</a>			
	920982	Drehboden kpl. 1350 KB-WL2   <a href="#">Turn Bottom cpl.</a>	1350
	920983	Drehboden kpl. 1500 KB-WL2   <a href="#">Turn Bottom cpl.</a>	1500
	920984	Drehboden kpl. 1650 KB-WL2   <a href="#">Turn Bottom cpl.</a>	1650
	886575	Drehboden kpl. 1850 KB-WL2   <a href="#">Turn Bottom cpl.</a>	1850
Drehboden: KBF   <a href="#">Turn Bottom</a>			
	388620	Drehboden kpl. 520 KBF   <a href="#">Turn Bottom cpl.</a>	520
	388631	Drehboden kpl. 780 KBF   <a href="#">Turn Bottom cpl.</a>	780
	388615	Drehboden kpl. 1350 KBF   <a href="#">Turn Bottom cpl.</a>	1350
Drehboden: KBF-K   <a href="#">Turn Bottom</a>			
	87829	Drehboden kpl. 520 KBF-K   <a href="#">Turn Bottom cpl.</a>	520
	88727	Drehboden kpl. 650 KBF-K   <a href="#">Turn Bottom cpl.</a>	650
	89129	Drehboden kpl. 780 KBF-K   <a href="#">Turn Bottom cpl.</a>	780
	89152	Drehboden kpl. 900 KBF-K   <a href="#">Turn Bottom cpl.</a>	900
	367231	Drehboden kpl. 1000 KBF-K   <a href="#">Turn Bottom cpl.</a>	1000
	89176	Drehboden kpl. 1060 KBF-K   <a href="#">Turn Bottom cpl.</a>	1060
	363915	Drehboden kpl. 1180 KBF-K   <a href="#">Turn Bottom cpl.</a>	1180
	62272	Drehboden kpl. 1350 KBF-K   <a href="#">Turn Bottom cpl.</a>	1350
	376562	Drehboden kpl. 1500 KBF-K   <a href="#">Turn Bottom cpl.</a>	1500



\* Wechselleiste siehe Kapitel „Allg. Verschleißteile und Zubehör KB“

\* Replaceable Ledge on Section „General Consumables and Accessories KB“

# Ersatzteile Bohrwerkzeuge

## Spare Parts Drilling Tools



Darstellung Illustration	Bauer-Best.Nr. Bauer Item No.	Bezeichnung Description	Ø Drehboden (mm) Ø Turn Bottom (mm)
<b>Drehboden: KBF-K2   Turn Bottom</b>			
	378776	Drehboden kpl. 1060 KBF-K2   Turn Bottom cpl.	1060
	373175	Drehboden kpl. 1350 KBF-K2   Turn Bottom cpl.	1350
	388393	Drehboden kpl. 1680 KBF-K2   Turn Bottom cpl.	1680
	371745	Drehboden kpl. 1830 KBF-K2   Turn Bottom cpl.	1830
<b>Drehboden: KBF-P   Turn Bottom</b>			
	885541	Drehboden kpl. 520 KBF-P   Turn Bottom cpl.	520
	885542	Drehboden kpl. 650 KBF-P   Turn Bottom cpl.	650
	885543	Drehboden kpl. 780 KBF-P   Turn Bottom cpl.	780
	885544	Drehboden kpl. 900 KBF-P   Turn Bottom cpl.	900
	885545	Drehboden kpl. 1060 KBF-P   Turn Bottom cpl.	1060
	885546	Drehboden kpl. 1180 KBF-P   Turn Bottom cpl.	1180
	885548	Drehboden kpl. 1350 KBF-P   Turn Bottom cpl.	1350
	885549	Drehboden kpl. 1500 KBF-P   Turn Bottom cpl.	1500



# Ersatzteile Bohrwerkzeuge

## Spare Parts Drilling Tools

### Schneidleisten für Bohrwerkzeuge | Cutting Ledges for Drilling Tools

SB einschneidig | Single Cut

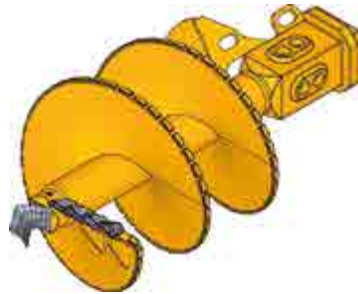

Bauer-Best.Nr. Bauer Item No.	Bezeichnung Description	Ø Schneckenbohrer (mm) Ø Auger (mm)
757588	Schneidleiste mit FZHI Cutting Ledge	520
757591		650
757595		780
757598		900
757603		1060
757607		1350

SB-2 zweischneidig | Double Cut

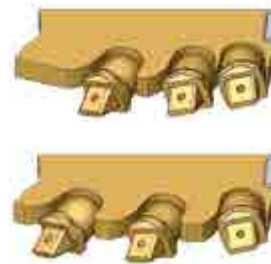

Bauer-Best.Nr. Bauer Item No.	Bezeichnung Description	Ø Schneckenbohrer (mm) Ø Auger (mm)
752387	Schneidleiste mit FZHI 1 Cutting Ledge	520
752460		650
752468		780
752474		900
752486		1060
752496		1350
752508		1650

Bauer-Best.Nr. Bauer Item No.	Bezeichnung Description	Ø Schneckenbohrer (mm) Ø Auger (mm)
752387	Schneidleiste mit FZHI 2 Cutting Ledge	520
752461		650
752469		780
752475		900
752487		1060
752496		1350
752509		1650



# Ersatzteile Bohrwerkzeuge

## Spare Parts Drilling Tools

SB-K einschneidig | Single Cut



Bauer-Best.Nr. Bauer Item No.	Bezeichnung Description	Ø Schneckenbohrer (mm) Ø Auger (mm)
757588	Schneidleiste mit FZHI Cutting Ledge	520
757591		650
757595		780
757598		900
757603		1060
757607		1350

SB-K2 zweischneidig | Double Cut



Bauer-Best.Nr. Bauer Item No.	Bezeichnung Description	Ø Schneckenbohrer (mm) Ø Auger (mm)
752387	Schneidleiste mit FZHI 1 Cutting Ledge	520
752460		650
752468		780
752474		900
752486		1060
752496		1350
752508		1650

Bauer-Best.Nr. Bauer Item No.	Bezeichnung Description	Ø Schneckenbohrer (mm) Ø Auger (mm)
752387	Schneidleiste mit FZHI 2 Cutting Ledge	520
752461		650
752469		780
752475		900
752487		1060
752496		1350
752509		1650

# Ersatzteile Bohrwerkzeuge

## Spare Parts Drilling Tools

SBF-K einschneidig | [Single Cut](#)



Bauer-Best.Nr. Bauer Item No.	Bezeichnung Description	Ø Schneckenbohrer (mm) Ø Auger (mm)
414298	Schneidleiste RSM Cutting Ledge	520
246812		650
246810		780
246808		900
246806		1060
102852		1350
756001		1650

SBF-K2 zweischneidig | [Double Cut](#)



Bauer-Best.Nr. Bauer Item No.	Bezeichnung Description	Ø Schneckenbohrer (mm) Ø Auger (mm)
784591	Schneidleiste RSM 1 Cutting Ledge	520
784592		650
784487		780
784560		900
784563		1060
784567		1350

Bauer-Best.Nr. Bauer Item No.	Bezeichnung Description	Ø Schneckenbohrer (mm) Ø Auger (mm)
784629	Schneidleiste RSM 2 Cutting Ledge	520
784630		650
784595		780
784598		900
784601		1060
784605		1350



# Ersatzteile Bohrwerkzeuge

## Spare Parts Drilling Tools

SBF-Z2 zweischneidig | Double Cut

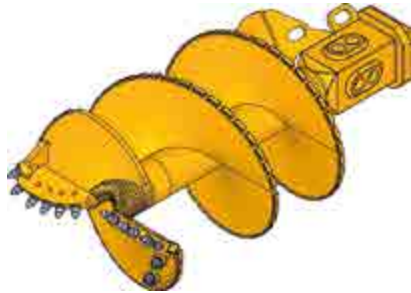

Bauer-Best.Nr. Bauer Item No.	Bezeichnung Description	Ø Schneckenbohrer (mm) Ø Auger (mm)
352975	Schneidleiste RSM 1 Cutting Ledge	520
352970		650
108920		780
352971		900
352972		1060
352974		1350
477415		1650

Bauer-Best.Nr. Bauer Item No.	Bezeichnung Description	Ø Schneckenbohrer (mm) Ø Auger (mm)
718532	Schneidleiste RSM 2 Cutting Ledge	520
352976		650
108927		780
352977		900
352978		1060
352980		1350
477416		1650



# Ersatzteile Bohrwerkzeuge

## Spare Parts Drilling Tools

KB einschneidig | Single Cut



Bauer-Best.Nr. Bauer Item No.	Bezeichnung Description	Ø Kastenbohrer (mm) Ø Drilling Bucket (mm)
850707	Schneidleiste mit FZHI Cutting Ledge	520
850708		650
850709		780
850710		900
850731		1060
850734		1350
850737		1650

KB-2 zweischneidig | Double Cut



Bauer-Best.Nr. Bauer Item No.	Bezeichnung Description	Ø Kastenbohrer (mm) Ø Drilling Bucket (mm)
802559	Schneidleiste mit FZHI 1 Cutting Ledge	1060
817209		1350
817313		1650

Bauer-Best.Nr. Bauer Item No.	Bezeichnung Description	Ø Kastenbohrer (mm) Ø Drilling Bucket (mm)
817204	Schneidleiste mit FZHI 2 Cutting Ledge	1060
817210		1350
817314		1650

# Ersatzteile Bohrwerkzeuge

## Spare Parts Drilling Tools



KB-K einschneidig | Single Cut



Bauer-Best.Nr. Bauer Item No.	Bezeichnung Description	Ø Kastenbohrer (mm) Ø Drilling Bucket (mm)
850707	Schneidleiste mit FZHI Cutting Ledge	520
850708		650
850709		780
850710		900
850731		1060
850734		1350
850737		1650

KB-K2 zweischneidig | Double Cut

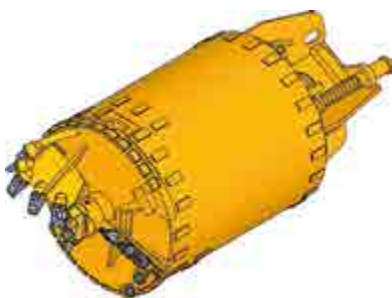

Bauer-Best.Nr. Bauer Item No.	Bezeichnung Description	Ø Kastenbohrer (mm) Ø Drilling Bucket (mm)
802559	Schneidleiste mit FZHI 1 Cutting Ledge	1060
817209		1350
817313		1650

Bauer-Best.Nr. Bauer Item No.	Bezeichnung Description	Ø Kastenbohrer (mm) Ø Drilling Bucket (mm)
817204	Schneidleiste mit FZHI 2 Cutting Ledge	1060
817210		1350
817314		1650

# Ersatzteile Bohrwerkzeuge Spare Parts Drilling Tools

KBF-K einschneidig | [Single Cut](#)

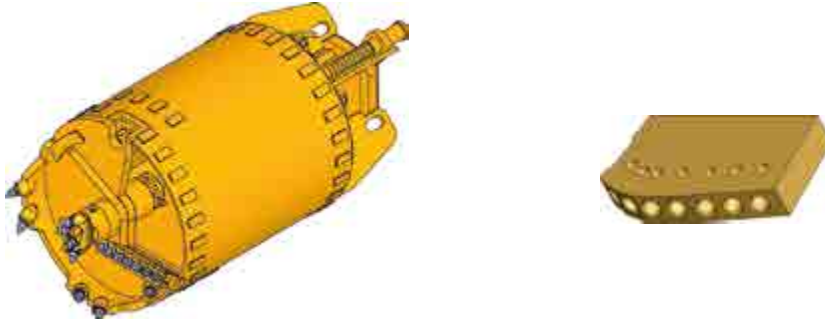

Bauer-Best.Nr. Bauer Item No.	Bezeichnung Description	Ø Kastenbohrer (mm) Ø Drilling Bucket (mm)
87630	Schneidleiste RSM Cutting Ledge	520
87632		650
87634		780
87635		900
87636		1060
62273		1350
731384		1650

KBF-K2 zweischneidig | [Double Cut](#)

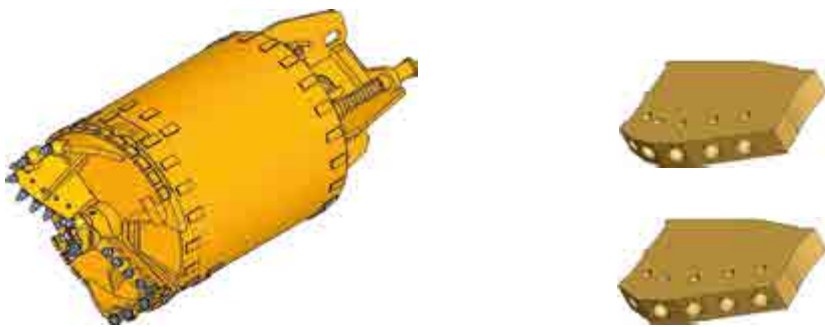

Bauer-Best.Nr. Bauer Item No.	Bezeichnung Description	Ø Kastenbohrer (mm) Ø Drilling Bucket (mm)
379007	Schneidleiste RSM 1 Cutting Ledge	1060
376702		1350
395060		1650

Bauer-Best.Nr. Bauer Item No.	Bezeichnung Description	Ø Kastenbohrer (mm) Ø Drilling Bucket (mm)
379006	Schneidleiste RSM 2 Cutting Ledge	1060
376689		1350
395061		1650



## Bauer Foundation Simulator

Der Bauer Foundation Simulator wurde von der BAUER Maschinen GmbH zur Simulation des Arbeitsablaufes im Spezialtiefbau mit einem Bauer-Gerät entwickelt.

### Vorteile

- Kostengünstiges Training und realitätsnahe Simulation
- Ideal geeignet als Einsteigertraining
- Sicherheit und Umweltschutz durch das Erlernen von Grundfähigkeiten in einer virtuellen Umgebung
- Steigerung der Produktivität im realen Betrieb durch Reduzierung der Einarbeitungszeit

*The Bauer Foundation Simulator has been developed by BAUER Maschinen GmbH to simulate the working process in special foundation construction with a Bauer rig.*

### Advantages

- *Cost-effective training and realistic simulation*
- *Ideally suited for training of beginners*
- *Safety and environmental protection by learning basic skills in a virtual environment*
- *Increase in productivity during actual operations by reducing the period required for training*

# Ersatzteile Bohrwerkzeuge

## Spare Parts Drilling Tools

### Ersatzteile Kastenbohrer einschneidig | Spare Parts Drilling Bucket Single Cut

Grundkörper Ø 520 - 780 | Main Body

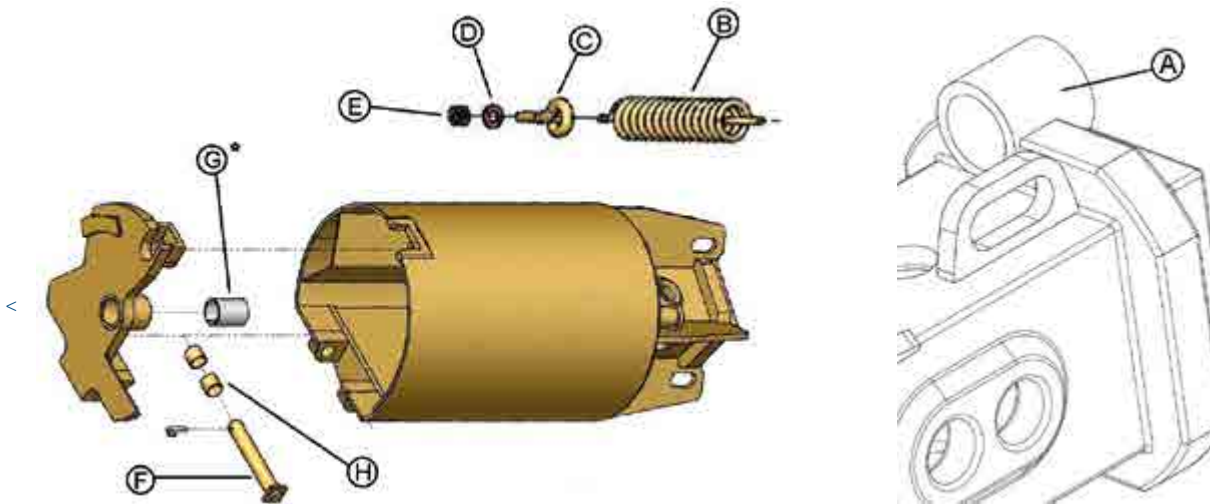

\* Ab Ø 970 wird diese Einspannbuchse 2x benötigt!

\* From Ø 970 two tension bushings required!

Bezeichnung Description	Bauer-Best.Nr. Bauer Item No.			
	A	B	C	D
Führungsrohr Guide Pipe		Zugfeder Spring	Gewindeöse Eyebolt	Scheibe Disc
KB-1 520 - 1200 KB-1 520 - 1500	128627	357730	246386	201988
KB-1 650 - 1200 KB-1 650 - 1500	128627	357730	246386	201988
KB-1 780 - 1200 KB-1 780 - 1500	-	357730	246386	201988

Bezeichnung Description	Bauer-Best.Nr. Bauer Item No.			
	E	F	G	H
Sechskantmutter Nut		Bolzen MK s+b Pin	Einspannbuchse Tension Bushing	Einspannbuchse Tension Bushing
KB-1 520 - 1200 KB-1 520 - 1500	208602	128326	85417 <sup>1</sup>	32206 <sup>3</sup>
KB-1 650 - 1200 KB-1 650 - 1500	208602	128326	48160 <sup>2</sup>	32206 <sup>3</sup>
KB-1 780 - 1200 KB-1 780 - 1500	208602	473575	48160 <sup>2</sup>	32206 <sup>3</sup>

<sup>1</sup> 65 x 55; L: 120 mm | <sup>2</sup> 105 x 90; L: 140 mm | <sup>3</sup> 60 x 50; L: 60 mm

# Ersatzteile Bohrwerkzeuge

## Spare Parts Drilling Tools



Grundkörper Ø 900 - 1650 | Main Body

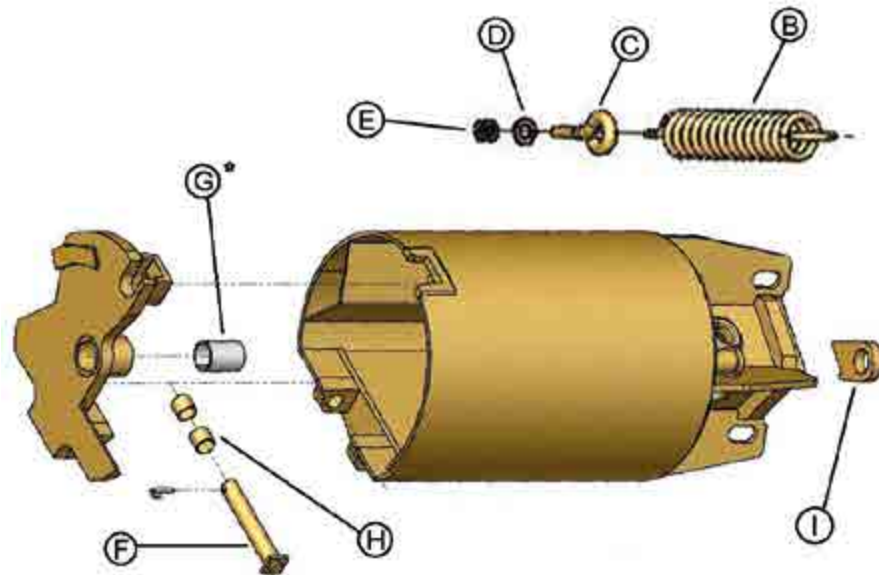

\* Ab Ø 970 wird diese  
Einspannbuchse 2x benötigt!

\* From Ø 970 two tension bushings required!

Bezeichnung Description	Bauer-Best.Nr. Bauer Item No.							
	B	C	D	E	F	G	H	I
	Zugfeder Spring	Gewinde- öse Eyebolt	Scheibe U-Form Disc	Sicherungs- mutter Nut	Bolzen/ U-Stift Pin/U-Pin	Einspann- buchse Bushing	Einspann- buchse Bushing	Führungs- auge 61 Lug
KB-1 900 - 1200 KB-1 900 - 1500	357730	246386	40841	208602	365812 305148	48160 <sup>*1</sup>	33108 <sup>*1</sup>	107991
KB-1 1000 - 1200 KB-1 1000 - 1500					365812 305148			
KB-1 1060 - 1200 KB-1 1060 - 1500					375571 305148			
KB-1 1180 - 1200 KB-1 1180 - 1500					375571 305148			
KB-1 1350 - 1200 KB-1 1350 - 1500	357730	246386	40841	208602	375720 305148	46634 <sup>*2</sup>	33108 <sup>*3</sup>	107991
KB-1 1500 - 1200 KB-1 1500 - 1500					375720 305148			
KB-1 1650 - 1200 KB-1 1650 - 1500					647842 305148			

<sup>\*1</sup> 105 x 90; L: 140 mm | <sup>\*2</sup> 135 x 120; L: 90 mm | <sup>\*3</sup> 70 x 60; L: 60 mm

# Ersatzteile Bohrwerkzeuge

## Spare Parts Drilling Tools

### Öffnerstange Ø 520 - 650 | Opening Rod

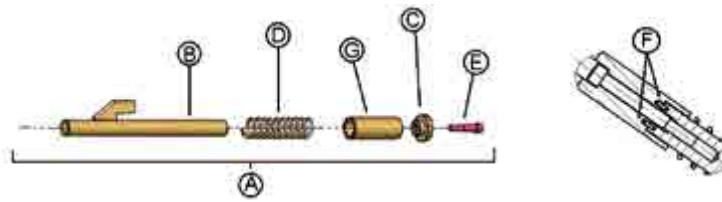

Bezeichnung Description	Bauer-Best.Nr. Bauer Item No.					
	A	B	C	D	E	F
	Öffnerstange kpl. Rod cpl.	Öffnerstange s+b Rod	Buchse s+b Bushing	Druck- feder Spring	Zyl. Schraube mit I-6-kant Screw	Spannstift leicht Pin
KB-1 520 - 1200 KB-1 520 - 1500	427091	427089	427092	54362	371945	20764
KB-1 650 - 1200 KB-1 650 - 1500	631220	427089	631134	54362	210801	20764

### Öffnerstange Ø 780 - 1650 | Opening Rod

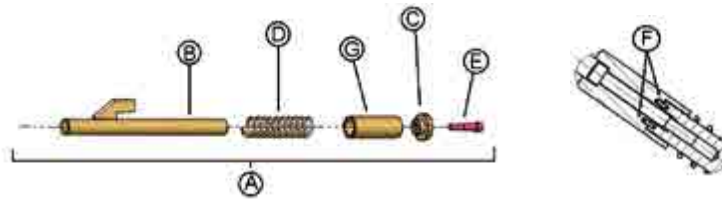

Bezeichnung Description	Bauer-Best.Nr. Bauer Item No.						
	A	B	C	D	E	F	G
	Öffner- stange kpl. Rod cpl.	Öffner- stange s+b Rod	Buchse Bushing	Druckfeder Spring	Zyl. Schraube mit I-6-kant M 24 x 120 Screw	Spannstift leicht Pin	Rohr 82,5 x 10 x 220 Pipe
KB-1 780 - 1200 KB-1 780 - 1500 KB-1 900 - 1200 KB-1 900 - 1500 KB-1 1000 - 1500 KB-1 1060 - 1200 KB-1 1060 - 1500 KB-1 1180 - 1200 KB-1 1180 - 1500 KB-1 1350 - 1200 KB-1 1350 - 1500 KB-1 1500 - 1200 KB-1 1500 - 1500 KB-1 1650 - 1200 KB-1 1650 - 1500	127968	375562	191111	54362	210801	20764	375563



# Ersatzteile Bohrwerkzeuge

## Spare Parts Drilling Tools

Verriegelungsstange Ø 520 - 780, L: 1200 | [Locking Rod](#)

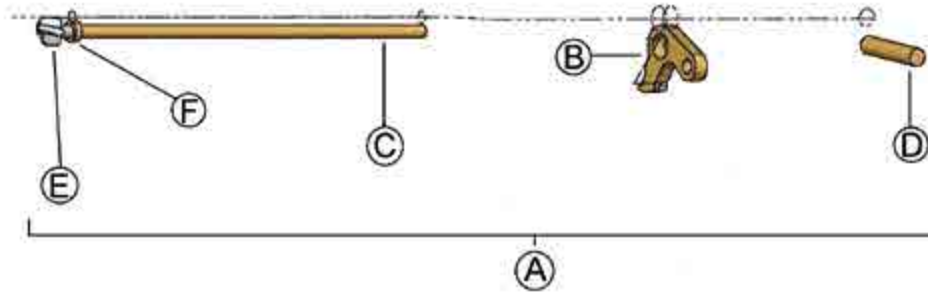

Bezeichnung Description	Bauer-Best.Nr. Bauer Item No.					
	A	B	C	D	E	F
Verriegelungs- stange s+b 1200 Rod	Drehherz s+b Lathe Dog	Rundstahl Steel	Rundstahl Steel	Verriegelungs- spitze Tip	Ring 36 Ring	
KB-1 520-1200 KB-1 650-1200 KB-1 780-1200	128303	128310	128306	128312	49282	86671

Verriegelungsstange Ø 520 - 780, L: 1500 | [Locking Rod](#)

Bezeichnung Description	Bauer-Best.Nr. Bauer Item No.					
	A	B	C	D	E	F
Verriegelungs- stange s+b 1500 Rod	Drehherz s+b Lathe Dog	Rundstahl Steel	Rundstahl Steel	Verriegelungs- spitze Tip	Ring 36 Ring	
KB-1 520-1500 KB-1 650-1500 KB-1 780-1500	128304	128310	128307	128312	49282	86671

# Ersatzteile Bohrwerkzeuge

## Spare Parts Drilling Tools

Verriegelungsstange Ø 900 - 1650, L: 1200 | [Locking Rod](#)

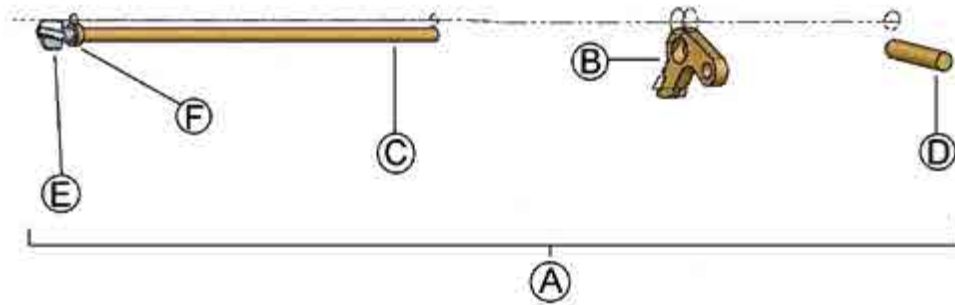

Bezeichnung Description	Bauer-Best.Nr. Bauer Item No.					
	A	B	C	D	E	F
Verriegelungs- stange s+b 1200 Rod		Drehherz s+b Lathe Dog	Rundstahl Steel	Rundstahl Steel	Verriegelungs- spitze Tip	Ring 36 Ring
KB-1 900 - 1200 KB-1 1000 - 1200 KB-1 1060 - 1200 KB-1 1180 - 1200 KB-1 1350 - 1200 KB-1 1500 - 1200 KB-1 1650 - 1200	375570	375569	139064	128312	49282	86671

Verriegelungsstange Ø 900 - 1650, L: 1500 | [Locking Rod](#)

Bezeichnung Description	Bauer-Best.Nr. Bauer Item No.					
	A	B	C	D	E	F
Verriegelungs- stange s+b 1500 Rod		Drehherz s+b Lathe Dog	Rundstahl Steel	Rundstahl Steel	Verriegelungs- spitze Tip	Ring 36 Ring
KB-1 900 - 1500 KB-1 1000 - 1500 KB-1 1060 - 1500 KB-1 1180 - 1500 KB-1 1350 - 1500 KB-1 1500 - 1500 KB-1 1650 - 1500	375948	375569	139065	128312	49282	86671

# Ersatzteile Bohrwerkzeuge

## Spare Parts Drilling Tools



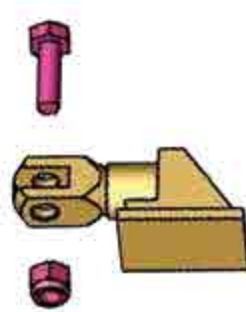

Riegel | Bar

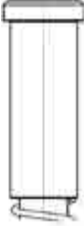

Bezeichnung Description		Bauer-Best.Nr. Bauer Item No.
KB-1 900 - 1200 / KB-1 900 - 1500	Riegel kpl. 190   Bar cpl.	375742
KB-1 1000 - 1200 / KB-1 1000 - 1500	Riegel kpl. 220   Bar cpl.	375636
KB-1 1060 - 1200 / KB-1 1060 - 1500	Riegel kpl. 150   Bar cpl.	375696
KB-1 1180 - 1200 / KB-1 1180 - 1500	Riegel kpl. 190   Bar cpl.	375742
KB-1 1350 - 1200 / KB-1 1350 - 1500	Riegel kpl. 270   Bar cpl.	485781
KB-1 1500 - 1200 / KB-1 1500 - 1500	Riegel kpl. 330   Bar cpl.	485783
KB-1 1650 - 1200 / KB-1 1650 - 1500	Riegel kpl. 400   Bar cpl.	519881

Bei einigen Ausrüstungen müssen zusätzlich folgende Teilenummern bestellt werden:  
For some special fittings the enclosed parts have to be ordered additionally:

Bezeichnung Description	Bauer-Best.Nr. Bauer Item No.			
				
	Auge Lug	Rohr 82,5 x 10 x 220 Pipe	Bolzen 50-690 MK s+b Pin	Buchse Bushing
KB-1 780 - 1200 KB-1 780 - 1500	128169	375563	473575	191111
KB-1 900 - 1200 KB-1 900 - 1500	-	375563	-	191111

# Ersatzteile Bohrwerkzeuge

## Spare Parts Drilling Tools

### Ersatzteile Kastenbohrer zweischneidig | Spare Parts Drilling Bucket Double Cut

Grundkörper Ø 1060-1830 | Main Body

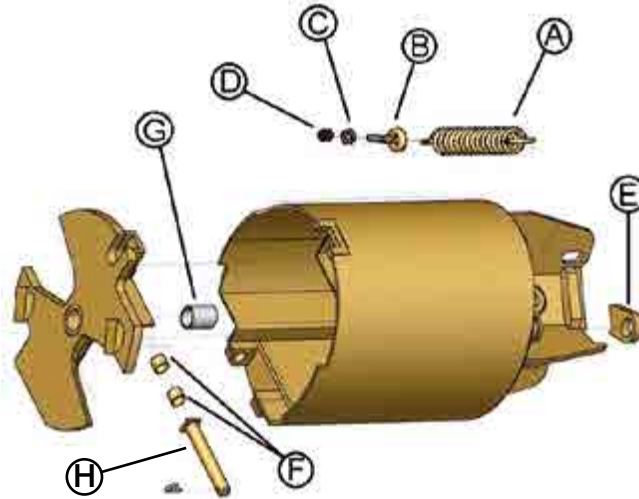

Bezeichnung Description	Bauer-Best.Nr. Bauer Item No.							
	A	B	C	D	E	F	G	H
	Zugfeder Spring	Gewinde- öse Eyebolt	Scheibe U-Form Disc	Sicherungs- mutter Nut	Führungs- auge 61 Lug	Einspann- buchse Bushing	Einspann- buchse Bushing	Bolzen Pin
KB-2 1060-1200 KB-2 1060-1500	357730	246386	40841	208602	107991	33108 <sup>*1</sup>	48160 <sup>*3</sup>	375684
KB-2 1180-1200 KB-2 1180-1500								547345
KB-2 1200-1200								
KB-2 1350-1500	357730	246386	40841	208602	107991	32208 <sup>*2</sup>	48160 <sup>*3</sup>	
KB-2 1380-1500								
KB-2 1500-1200 KB-2 1500-1500								547346
KB-2 1650-1200 KB-2 1650-1500	357730	246386	40841	208602	107991	32208 <sup>*2</sup>	46634 <sup>*4</sup> (2x)	547347
KB-2 1830-1500								

<sup>\*1</sup> 70 x 60; L: 60 mm | <sup>\*2</sup> 95 x 80; L: 70 mm | <sup>\*3</sup> 105 x 90; L: 140 mm | <sup>\*4</sup> 135 x 120; L: 90 mm

# Ersatzteile Bohrwerkzeuge

## Spare Parts Drilling Tools



Öffnerstange Ø 1060-1830 | Opening Rod

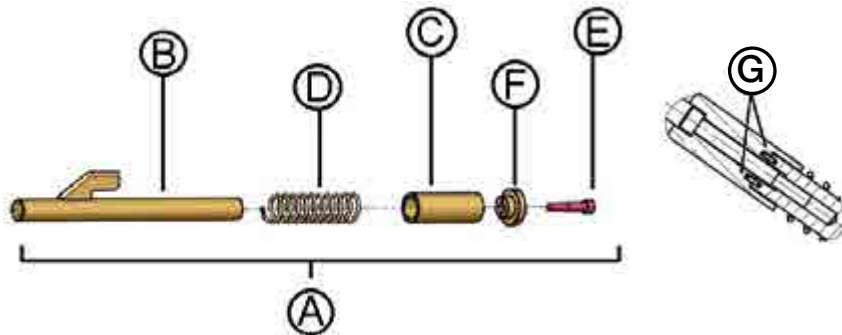

Bezeichnung Description	Bauer-Best.Nr. Bauer Item No.						
	A	B	C	D	E	F	G
	Öffner- stange kpl. Rod cpl.	Öffner- stange s+b Rod	Rohr 82,5 x 10 x 220 Pipe	Druckfeder Spring	Zyl. Schraube mit I-6-kant M 24 x 120 Screw	Buchse Bushing	Spannstift leicht Pin
KB-2 1060-1200 KB-2 1060-1500							
KB-2 1180-1200 KB-2 1180-1500							
KB-2 1200-1200							
KB-2 1350-1500	127968	375562	375563	54362	210801	191111	20764
KB-2 1380-1500							
KB-2 1500-1200 KB-2 1500-1500							
KB-2 1650-1200 KB-2 1650-1500							
KB-2 1830-1500							

# Ersatzteile Bohrwerkzeuge

## Spare Parts Drilling Tools

Verriegelungsstange Ø 1060-1650, L: 1200 | [Locking Rod](#)

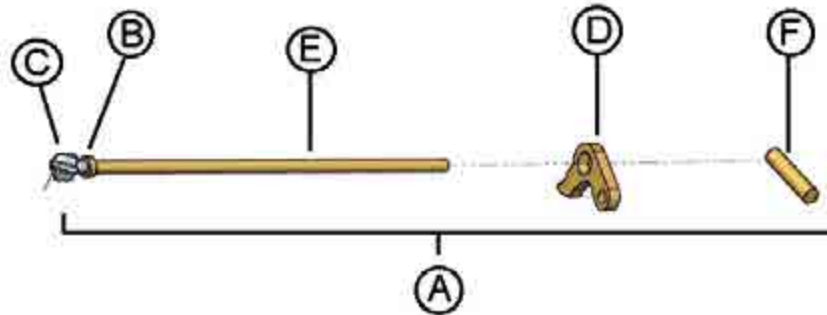

Bezeichnung Description	Bauer-Best.Nr. Bauer Item No.					
	A	B	C	D	E	F
Verriegelungs- stange s+b 1200 Rod		Ring Ring	Verriegelungs- spitze Tip	Drehherz s+b Lathe Dog	Rundstahl Steel	Rundstahl Steel
KB-2 1060-1200 KB-2 1180-1200 KB-2 1200-1200 KB-2 1500-1200	375570	86671	49282	375569	139064	128312
KB-2 1650-1200	548193	519090	62102	548192	548026	128312

Verriegelungsstange Ø 1060-1830, L: 1500 | [Locking Rod](#)

Bezeichnung Description	Bauer-Best.Nr. Bauer Item No.					
	A	B	C	D	E	F
Verriegelungs- stange s+b Rod		Ring Ring	Verriegelungs- spitze Tip	Drehherz s+b Lathe Dog	Rundstahl Steel	Rundstahl Steel
KB-2 1060-1500	375949	86671	49282	375569	139066	128312
KB-2 1180-1500 KB-2 1350-1500 KB-2 1380-1500 KB-2 1500-1500	375948	86671	49282	375569	139065	128312
KB-2 1650-1500 KB-2 1830-1500	548194	519090	62102	548192	548027	128312

# Ersatzteile Bohrwerkzeuge

## Spare Parts Drilling Tools



Riegel Ø 1060-1830 | Bar

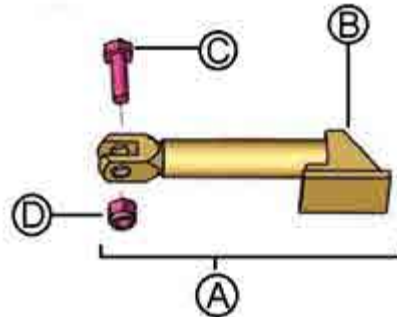





Bezeichnung Description	Bauer-Best.Nr. Bauer Item No.			
	A	B	C	D
	Riegel kpl. Bar cpl.	Riegel s+b Bar	Sechskantschraube Screw	Sicherungsmutter Nut
KB-2 1060-1200 KB-2 1060-1500	519866	717910	45179	208605
KB-2 1180-1200 KB-2 1180-1500 KB-2 1200-1200	519880	717918	45179	208605
KB-2 1350-1500	519882	717920	45179	208605
KB-2 1380-1500	485783	717912	45179	208605
KB-2 1500-1200 KB-2 1500-1500	519881	717919	45179	208605
KB-2 1650-1200 KB-2 1650-1500	548274	548273 (Keil s+b 282) (Wedge)	35323	231234
KB-2 1830-1500	548353	548273 (Keil s+b 282) (Wedge)	35323	231234

# Ersatzteile Bohrwerkzeuge

## Spare Parts Drilling Tools

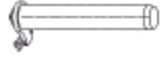
Bei einigen Ausrüstungen müssen zusätzlich folgende Teilenummern bestellt werden:

For some special fittings the enclosed parts have to be ordered additionally:

Bezeichnung Description	Bauer-Best.Nr. Bauer Item No.			
				
	Bolzen kpl. Bolt cpl.	Gewindestange M 30 x 140 Rod	Gewindestange M 30 x 230 Rod	Gabelkopf s+b Fork Head
KB-2 1180-1200 KB-2 1180-1500	547345	-	-	-
KB-2 1650-1200 KB-2 1650-1500	547347	548270	-	621891
KB-2 1830-1500	547347	-	548258	621891









# Ersatzteile Bohrwerkzeuge

## Spare Parts Drilling Tools

### Allgemeine Verschleiß- und Ersatzteile Bohrwerkzeuge | General Wear and Spare Parts Drilling Tools





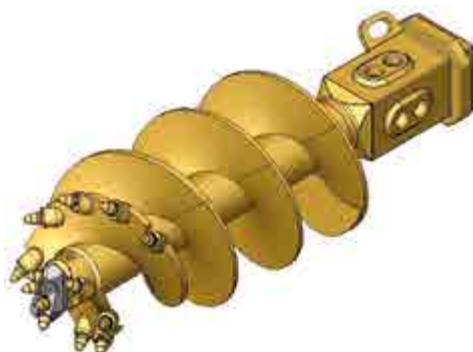

Darstellung Illustration	Bauer-Best.Nr. Bauer Item No.	Zusatzrüstung pro Stück Additional Equipment per Unit		Optionale zus. Ausgleichsscheiben pro Stück Optional Additional Shims per Unit	
	Bezeichnung Description	Bauer-Best.Nr. Bauer Item No.	Bezeichnung Description	Bauer-Best.Nr. Bauer Item No.	Abmessungen (mm) Dimensions (mm)
	86676	602775	Sechskantschraube (1x) Hexagon Screw	440545	100 x 57 x 2
	Stelling 55 KB-1 520-599 Retaining Ring	208604	Sicherungsmutter (1x) Locking Nut	440548	100 x 57 x 3
	87689	602774	Sechskantschraube (1x) Hexagon Screw	440551	100 x 57 x 4
	Stelling 75 KB-1 600-960 KB-2 1000-1500 Retaining Ring	208605	Sicherungsmutter (1x) Locking Nut	440564	100 x 57 x 5
	49153	Aufspannbuchse Bolzen Drehboden (1x) Outer Tension Bushing Bolt Turn Bottom	440546	145 x 77 x 2	
	48273	602776	Sechskantschraube (1x) Hexagon Screw	440549	145 x 77 x 3
	Stelling 105 KB-1 961-1500 KB-2 1501-3000 Retaining Ring	254735	Sicherungsmutter (1x) Locking Nut	440552	145 x 77 x 4
	700803	Aufspannbuchse Bolzen Drehboden (2x) Outer Tension Bushing Bolt Turn Bottom	440565	145 x 77 x 5	
	Wechselbare Räumerleiste Replaceable Ledge	697124	Wechselleiste WL Replaceable Ledge WL	440547	195 x 107 x 2
	35575	Spannstift WL Pin WL	440550	195 x 107 x 3	
				440563	195 x 107 x 4
				440566	195 x 107 x 5

# Ersatzteile Bohrwerkzeuge

## Spare Parts Drilling Tools



Darstellung Illustration	Bauer-Best. Nr. Bauer Item No.	Bezeichnung Description
	63648	Kellybox 110
	923199	Kellybox 130
	163760	Kellybox 150
	80750	Kellybox 200
	743023	Kellybox 200, kurz Kellybox Short
	205410	Bolzen 25 - 145 SO Pin

Darstellung Illustration	Bauer-Best. Nr. Bauer Item No.	Bezeichnung Description
	919209	Bolzen 36 - 218 MB Pin
	1030966	Scheibe Disc
	163778	Bolzen 40 - 263 MB Pin
	205413	Bolzen 60 - 316 MB Pin
	21116	Klappstecker 8 x 42 Linch Pin
	391724	Sicherheits- klappstecker Ø 11,5 mm Safety Split Pin
	305148	U-Sicherungsstift für   for Ø 60 mm U-Safety Pin

# Ersatzteile Bohrwerkzeuge





## Spare Parts Drilling Tools

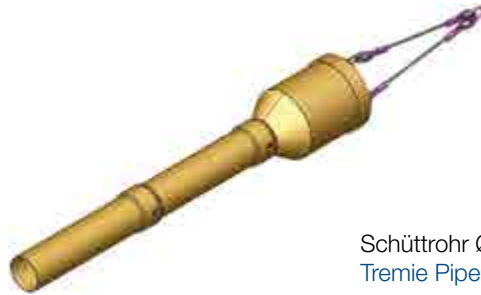

### Betonierschüttrohre | Tremie Pipe Systems



Schüttrohr Ø 244,5 mm  
Tremie Pipe



Schüttrohrsystem einfach abgedichtet*   Tremie Pipe Systems, Single Sealed*					
Darstellung Illustration 	Bauer-Best.Nr. Bauer Item No.	Bezeichnung Description	Ø Schütttrichter (mm) Ø Hopper (mm)	Ø Bohrrohr (mm) Ø Casing (mm)	Gewicht (kg) Weight (kg)
	383846	Schütttrichter einfach abgedichtet  Hopper Single Sealed	400	-	41
	89694		500	620	65
	89693		600	750	70
	89692		750	880	85
	89691		850	1000	115
	641209		850	1180	115
	89690		1150	> 1180	195
50139	Anschlagseil   Lifting Rope	-	-	-	
Darstellung Illustration 	Bauer-Best.Nr. Bauer Item No.	Bezeichnung Description	Länge (mm) Length (mm)		Gewicht (kg) Weight (kg)
	202686	Schüttrohr einfach abgedichtet  Tremie Pipe Single Sealed	1.000		40
	202687		1.500		55
	202688		2.000		70
	202689		3.000		100
	202690		4.000		130
	202691		5.000		160
	202692		6.000		190
	89700	Vaterteil   Male Connector	-		
89701	Mutterteil   Female Connector	-			
Darstellung Illustration 	Bauer-Best.Nr. Bauer Item No.	Bezeichnung Description	Länge (mm) Length (mm)		Gewicht (kg) Weight (kg)
	202913	Anfangsrohr einfache Dichtung  Starter Pipe Single Sealed	1.000		35
	202914		1.500		50
	202915		2.000		65
	202916		3.000		95
	202917		4.000		125
	202918		5.000		155
202919	6.000			185	
Darstellung Illustration 	Bauer-Best.Nr. Bauer Item No.	Bezeichnung Description	Länge (mm) Length (mm)		Gewicht (kg) Weight (kg)
202684	Kappe einfach abgedichtet  Cap Single Sealed	-		15	



\* Nicht kompatibel mit Schüttrohrsystem doppelt abgedichtet

\* Incompatible with double sealed tremie pipe system

# Ersatzteile Bohrwerkzeuge

## Spare Parts Drilling Tools

Schüttrohrsystem doppelt abgedichtet*   Tremie Pipe Systems, Double Sealed*					
Darstellung Illustration	Bauer-Best.Nr. Bauer Item No.	Bezeichnung Description	Schütttrichter (mm) Hopper (mm)	Ø Bohrrohr (mm) Ø Casing (mm)	Gewicht (kg) Weight (kg)
	641155	Schütttrichter doppelt abgedichtet  Hopper Double Sealed	400	-	54
	641156		500	620	67
	641157		600	750	79
	641208		750	880	98
	641209		850	1000	141
	641209		850	1180	141
	641210		1150	> 1180	198
	50139	Anschlagseil   Lifting Rope	-		
Darstellung Illustration	Bauer-Best.Nr. Bauer Item No.	Bezeichnung Description	Länge (mm) Length (mm)	Gewicht (kg) Weight (kg)	
	635526	Schüttrohr doppelt abgedichtet  Tremie Pipe Double Sealed	1000	50	
	635527		1500	65	
	635528		2000	80	
	635529		3000	110	
	635530		4000	140	
	635531		5000	170	
	635532		6000	200	
	635516	Vaterteil   Male Connector	-		
	635517	Mutterteil   Female Connector	-		
	635579	Anfangsrohr doppelt abgedichtet  Starter Pipe Double Sealed	1.000	42	
	635580		1.500	57	
	635581		2.000	72	
	635582		3.000	101	
	635583		4.000	131	
	635584		5.000	161	
	635585		6.000	191	
	635561	Kappe doppelt abgedichtet  Cap Double Sealed	-	15	







Verbindungselemente   Coupling Components		
	52119	Sicherungsseil   Locking Rope
	200613	O-Ring   O-Ring

\* Nicht kompatibel mit Schüttrohrsystem einfach abgedichtet  
\* Incompatible with single sealed tremie pipe system



# Ersatzteile Bohrwerkzeuge

## Spare Parts Drilling Tools

Betonierequipment   Concreting Equipment					
Darstellung Illustration	Bauer-Best.Nr. Bauer Item No.	Bezeichnung Description	Ø Bohrohr (mm) Ø Casing (mm)	Gewicht (kg) Weight (kg)	
	202674	Abfanggabel Support Fork	– 620	10	
	52322		– 880	10	
	52323		– 1300	12	
	52324		– 1800	16	
	361272		– 2500	32	
Darstellung Illustration	Bauer-Best.Nr. Bauer Item No.	Bezeichnung Description	max. Rohrlänge max. Length of Pipes	Anzahl Schüttröhre Number of Tremie Pipes	Gesamtgewicht (Nutzlast) Total Weight (Weight of Tremie Pipes)
	695715	Schüttröhrmagazin Tremie Pipe Rack	6 m	16	7.800 kg (4.600 kg)
	694767		3 m	16	3.800 kg (2.300 kg)
Darstellung Illustration	Bauer-Best.Nr. Bauer Item No.	Bezeichnung Description			
	200026	Betonierball Ø 210 mm   Concreting Ball			
	216100	Luftpumpe für Betonierball   Air Pump Concreting Ball			
	1190579	Schüttbolzen kpl.   Plug Bolt cpl.			
	1124518	Wirbellasthaken 6,5 to   Swivel Hook			
	21436	Blaspistole, Stecknippel   Blow Pistol, Nipple			
	72600	Verlängerungseinsätze 100 mm für Pistole   Extension Rod for Pistol			

# Ausrüstung Schrägpfähle

## Equipment For Inclined Drilling

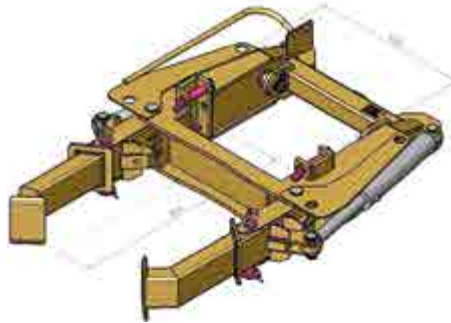

Schrägbohrführung   Guide Arms for Drill Pipe			
Bauer-Best.Nr. Bauer Item No.	Bezeichnung Description	Bohrachse (mm) Drill Axis (mm)	Mastbreite (mm) Mast Width (mm)
1272199	Schrägbohrführung kpl. (ohne Arme)   Guide f. Inclined Drilling cpl. (w/o arms)	1100	600
1272200	Arme für Bohrröhr Ø 880   Guide Arms for Drill Pipe	-	-
1277261	Arme für Bohrröhr Ø 1000   Guide Arms for Drill Pipe	-	-
1272262	Arme für Bohrröhr Ø 1180   Guide Arms for Drill Pipe	-	-
1297385	Schrägbohrführung kpl. (ohne Arme)   Guide f. Inclined Drilling cpl. (w/o arms)	1300	900
1297384	Arme für Bohrröhr Ø 1500   Guide Arms for Drill Pipe	-	-
1291770	Schrägbohrführung kpl. (ohne Arme)   Guide f. Inclined Drilling cpl. (w/o arms)	1550	900
1291763	Arme für Bohrröhr Ø 880   Guide Arms for Drill Pipe	-	-
1291764	Arme für Bohrröhr Ø 1000   Guide Arms for Drill Pipe	-	-
1291765	Arme für Bohrröhr Ø 1180   Guide Arms for Drill Pipe	-	-
1291766	Arme für Bohrröhr Ø 1500   Guide Arms for Drill Pipe	-	-
1291767	Arme für Bohrröhr Ø 1800   Guide Arms for Drill Pipe	-	-



# Ausrüstung Schrägpfähle

## Equipment For Inclined Drilling

### Obere Kellyführung\* | Upper Kelly Guide\*

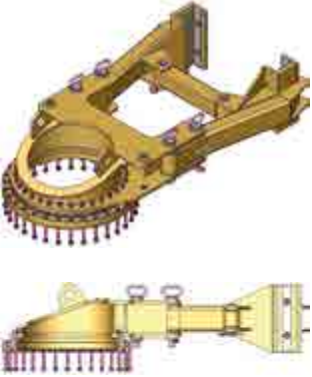
Darstellung Illustration	Bauer-Best.Nr. Bauer Item No.	passend für Kellytyp fits to Kelly Type	Bohrachse (mm) Drill Axis (mm)	Mastprofil (mm) Mast Profile (mm)
 <p>repräsentative Darstellung (Bauer Best.Nr. 845637)</p> <p>representative illustration (Bauer Item No. 845637)</p>	845851	BK XXX/368/X/XX	900	600 x 80 x 80
	845637	BK XXX/394/X/XX BK XXX/419/X/XX	1000	
	841131		1100	
	841132		1400	
	1170874		1100	
	1170875		1400	
	841131		BK XXX/470/X/XX	
	841132	1400		
	787043	BK XXX/470/X/XX	1300	900 x 80 x 80
	926913		1300	
	787044		1550	
	787045		1700	

### Kellystabilisator | Intermediate Stabiliser

Darstellung Illustration	Bauer-Best.Nr. Bauer Item No.	Bezeichnung Description
	auf Anfrage  on request	<p>Kellystabilisatoren (Knickstützen) werden bei Schrägpfahlbohrungen &gt; 5° empfohlen. Da diese abhängig vom Bohrröhrinnendurchmesser sind, sind diese individuell auf Anfrage erhältlich.</p> <p>Intermediate stabilisers (buckling restrained braces) are recommended for inclined pile bores &gt; 5°. They are available on individual request as they are dependent on the drill pipe inner diameter.</p>

### Abstandshalter für Schüttrohre\*\* | Spacer for Tremie Pipes\*\*

Darstellung Illustration	Bauer-Best.Nr. Bauer Item No.	passend für Pfahldurchmesser fits to Pile Diameter	Ø OD Abstandshalter (mm) Ø OD Spacer (mm)
	1121139	880	500
	1121140	1000	620
	1121161	1180	800
	1121162	1500	920

\* Weitere Versionen auf Anfrage verfügbar | Further versions are available on request

\*\* Auf Schüttrohr einfach abgedichtet montierbar | Mountable on single sealed tremie pipe



## Kellystangen Kelly Bars



---

Kellystangen Kelly Bars	78 - 129
· BK130/343/4/XX-S	78 - 82
· BK170/343/3/XX-S	84 - 87
· BK200/368/3/XX-S	88 - 91
· BK200/368/4/XX-S	92 - 96
· BK250/394/4/XX-S	98 - 102
· BK260/394/3/XX-S	104 - 107
· BK280/419/4/XX-S	108 - 112
· BK300/419/3/XX-S	114 - 117
· BK420/470/3/XX-S	118 - 121
· BK420/470/4/XX-S	122 - 126

### Erläuterung | Explanation:

° Abhängig von der Kelly-Baunummer  
Depending on construction number of kelly bar

\* Gewünschte Länge angeben  
Specify desired length

Bei jeder Bestellung von Ersatz- und Verschleißteilen bitte Kellytyp, Baunummer, Positionsnummer und Materialnummer angeben.

When ordering parts, please give type of kelly, kelly construction number, item number and material number.

· Kellyverlängerung Kelly Extension	128
· Kelly Box Adapter Kelly Box Adapter	129

---

Weitere Kellystangen finden Sie in unserem Kelly-Katalog oder in myBAUER.

Further Kelly Bars can be found in our Kelly Catalog or on myBAUER.

# Kelly BK130/343/4/XX-S

## Kelly Bar

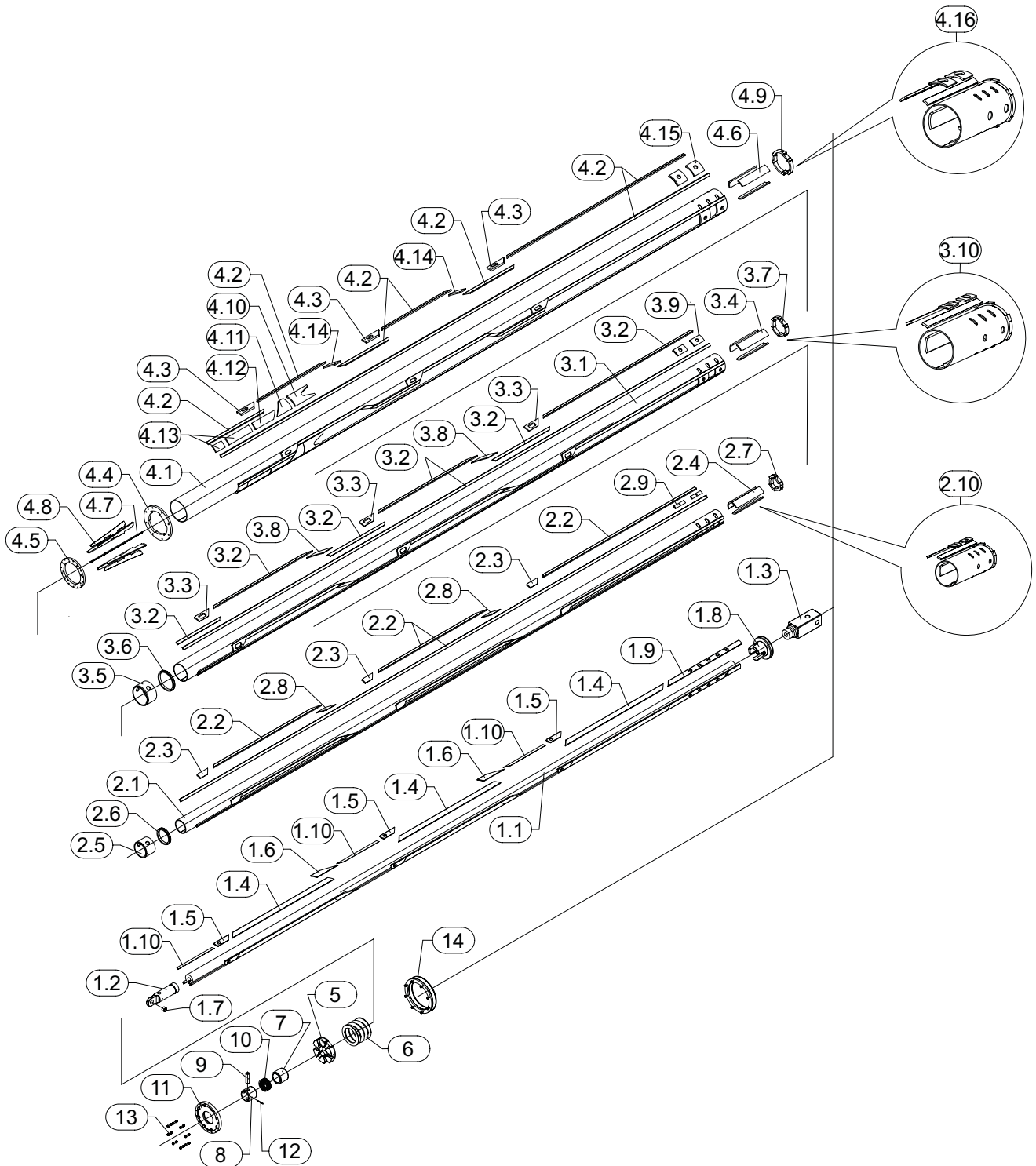

# Kelly BK130/343/4/XX-S

## Kelly Bar

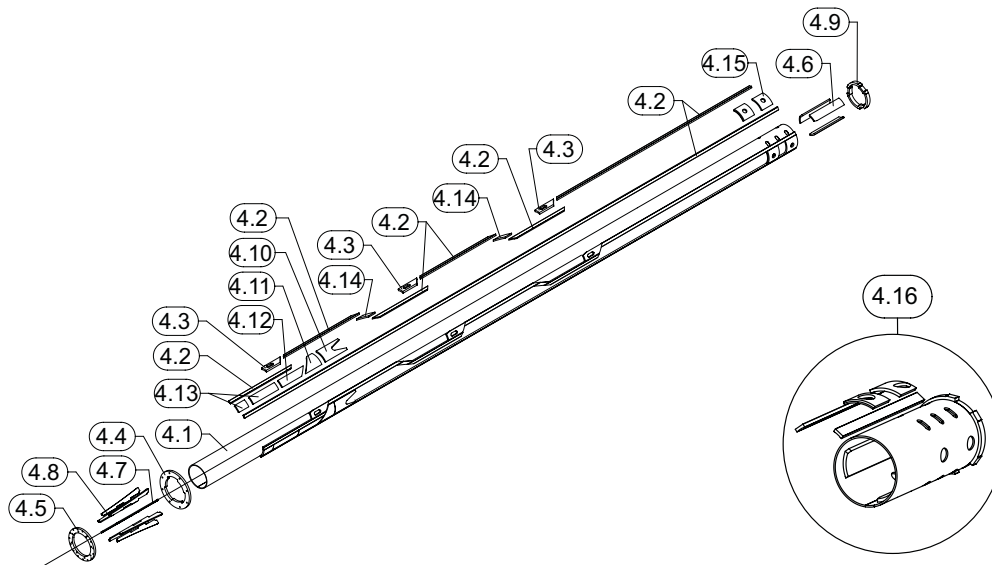

Außenkelly kpl.   Outer Kelly cpl.			
Darstellung Illustration	Bauer-Best.Nr. Bauer Item No.	Bezeichnung Description	Menge (Stck.) Quantity (pcs.)
4.1	51662	Rund-Hohlprofil nahtlos 343-8,8   Round Hollow Sec. Seamless	1*
4.2	1018282	Profilstahl 40 x 22   Section Steel	1*
4.3	96726	Anschlag   Stop	1*
4.4	1093668	Bodenplatte   Plate	1
4.5	1093669	Ring   Ring	1
4.6	1093680	Mitnehmerschale   Driving Shell	3
4.7	1093671	Blech   Sheet	3
4.8	1093673	Blech   Sheet	5
4.9	1093674	Kellyanfänger s+b   Kelly End	1
4.10	399682	Stützschale   Shell	3
4.11	402916	Stützschale   Shell	3
4.12	389935	Stützschale   Shell	3
4.13	389872	Stützschale   Shell	6
4.14	1402820	Schrägsegment   Shell	1*
4.15	1093670	Endschale   End Husk	6
4.16	1100095	Kellyanfänger kpl.   Kelly End cpl.	1
4.17	1103360	Schalldämmplatte 343   Sound Absorber	1*
4.18	1103359	Blechplatte 343   Sheet	1*
4.19	47052	Bandstahl B: 20, S: 3   Steel Strip W: 20, T: 3	1*

# Kelly BK130/343/4/XX-S

## Kelly Bar

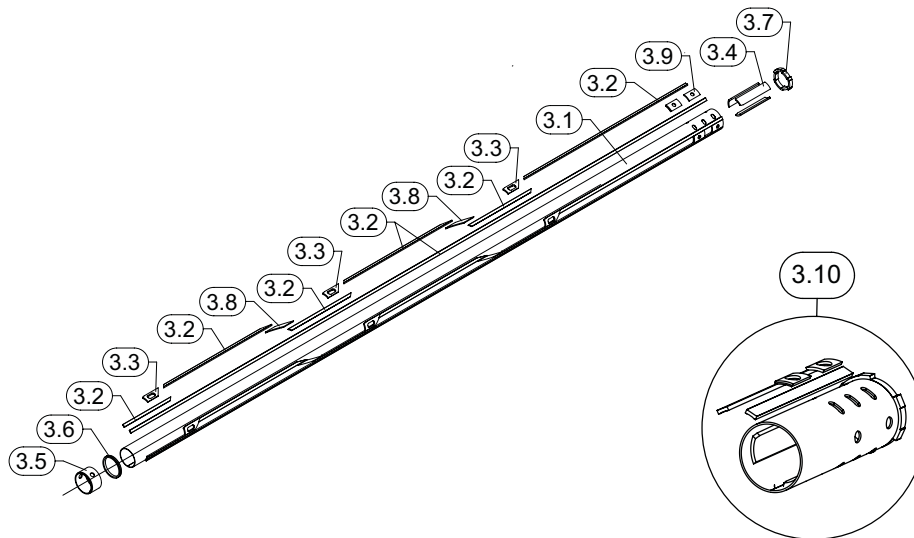

Zwischenkelly kpl.   Intermediate Kelly cpl.			
Darstellung Illustration	Bauer-Best.Nr. Bauer Item No.	Bezeichnung Description	Menge (Stck.) Quantity (pcs.)
3.1	427918	Stahlrohr nahtlos 279-8   Tube Seamless	1*
3.2	1007811	Profilstahl 40 x 18   Section Steel	1*
3.3	369263	Anschlag Druckseite   Stop Pressure Side	1*
3.4	1093863	Mitnehmerschale   Driving Shell	3
3.5	369093	Zentrierring   Center Ring	1
3.6	369092	Verschleißring   Wear Ring	2
3.7	1093868	Kellyanfänger   Kelly End	1
3.8	1403316	Schrägsegment   Shell	1*
3.9	1093869	Endschale   End Husk	6
3.10	1100154	Kellyanfänger kpl.   Kelly End cpl.	1

# Kelly BK130/343/4/XX-S

## Kelly Bar

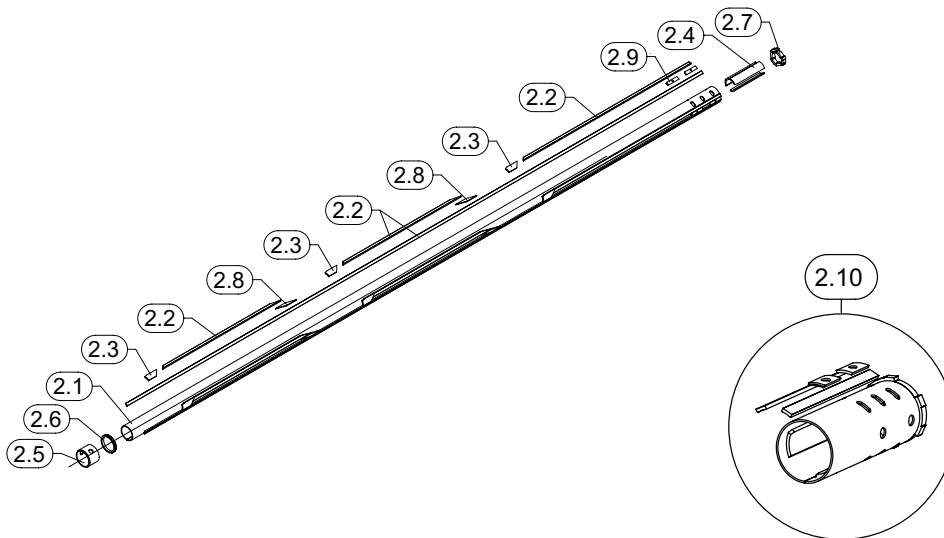

Mittelkelly kpl.   Mid Kelly cpl.			
Darstellung Illustration	Bauer-Best.Nr. Bauer Item No.	Bezeichnung Description	Menge (Stck.) Quantity (pcs.)
2.1	411394	Stahlrohr nahtlos 216-11   Tube Seamless	1*
2.2	1007811	Profilstahl 40 x 18   Section Steel	1*
2.3	112449	Anschlag   Stop	1*
2.4	1097986	Mitnehmerschale   Driving Shell	3
2.5	370946	Zentrierring   Center Ring	1
2.6	370948	Verschleißring   Wear Ring	2
2.7	1097987	Kellyanfänger   Kelly End	1
2.8	1403734	Schrägsegment   Shell	1*
2.9	1097988	Endschale   End Husk	6
2.10	1102764	Kellyanfänger kpl.   Kelly End cpl.	1

# Kelly BK130/343/4/XX-S

## Kelly Bar

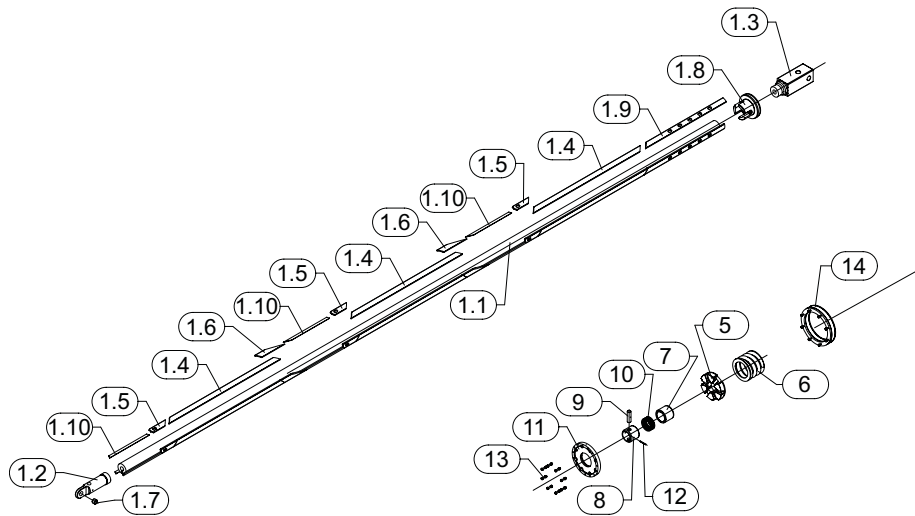

Innenkelly kpl.   Inner Kelly cpl.			
Darstellung Illustration	Bauer-Best.Nr. Bauer Item No.	Bezeichnung Description	Menge (Stck.) Quantity (pcs.)
1.1	412206	Stahlrohr nahtlos 150-45   <a href="#">Tube Seamless</a>	1*
1.2	1098012	Anfangsstange   <a href="#">Initial Rod</a>	1
1.3	415425	Vierkant 200   <a href="#">Square</a>	1
1.4	1052137	Profilstahl 70 x 18   <a href="#">Section Steel</a>	1*
1.5	984803	Anschlag Druckseite   <a href="#">Stop Pressure Side</a>	1*
1.6	1051990	Schrägsegment-IK   <a href="#">Shell</a>	1*
1.7	32177	Einspannbuchse f. Lagerungen 50 x 40   <a href="#">Tension Bushing int. Application</a>	1
1.8	415426	Muffe   <a href="#">Sleeve</a>	1
1.9	750637	Profilstahl   <a href="#">Section Steel</a>	3
1.10	47818	Profilstahl 30 x 17   <a href="#">Section Steel</a>	1*
5.0	415429	Druckplatte   <a href="#">Pressure Plate</a>	1
6.0	77771	Schraubendruckfeder   <a href="#">Spring</a>	1
7.0	1098303	Zentrierring   <a href="#">Center Ring</a>	1
8.0	16451	Hülse   <a href="#">Sleeve</a>	1
9.0	77784	Bolzen 50-160 OK   <a href="#">Pin</a>	1
10.0	16452	Ring   <a href="#">Ring</a>	3
11.0	1098307	Deckel   <a href="#">Cover</a>	1
12.0	21075	Spannstift schwer 10 x 100   <a href="#">Spring Pin Heavy</a>	1
13.0	1094317	Verschraubung   <a href="#">Screwing</a>	8
14.0	1098495	Dämpfer kpl.   <a href="#">Damper cpl.</a>	1

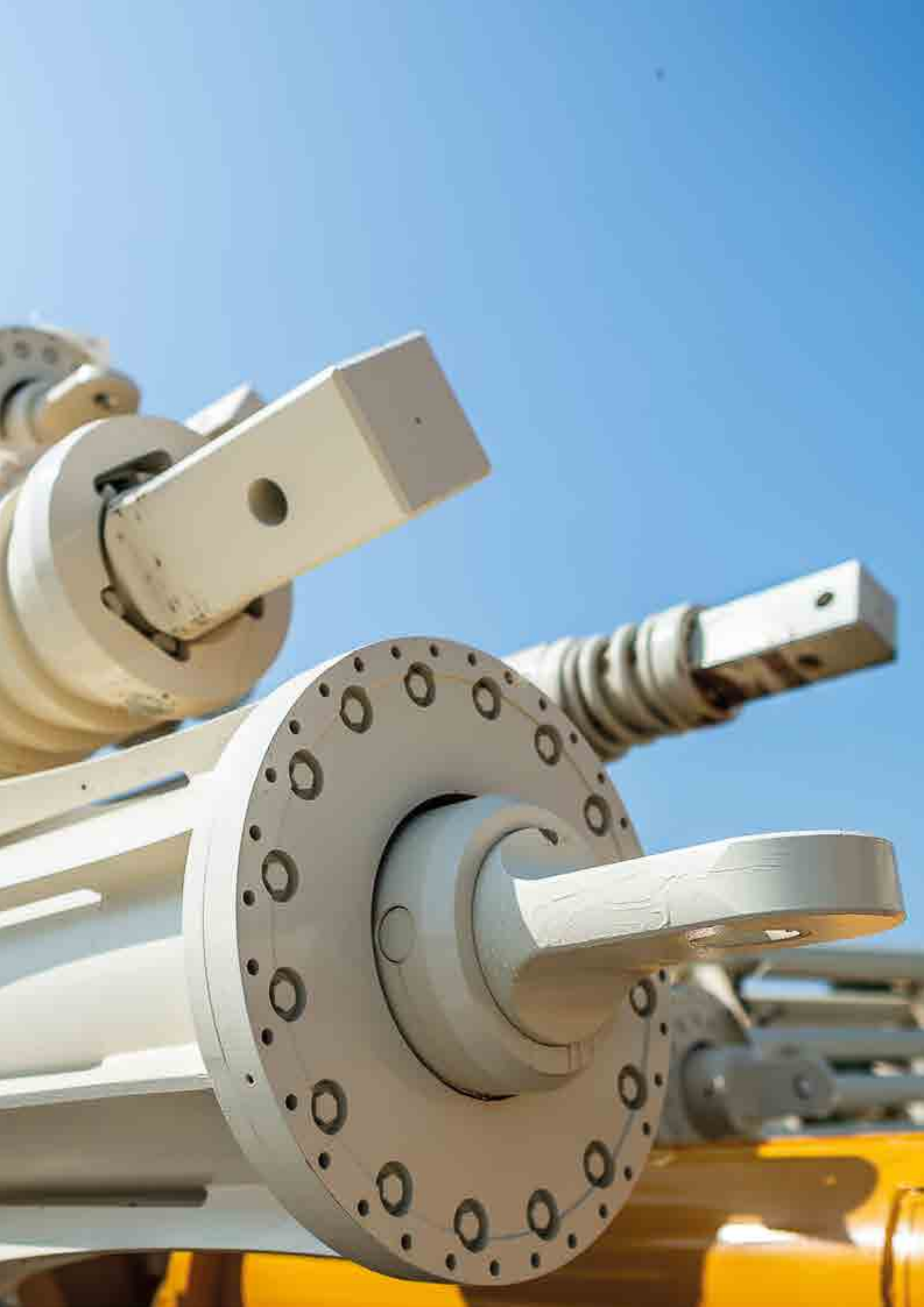

# Kelly BK170/343/3/XX-S

## Kelly Bar

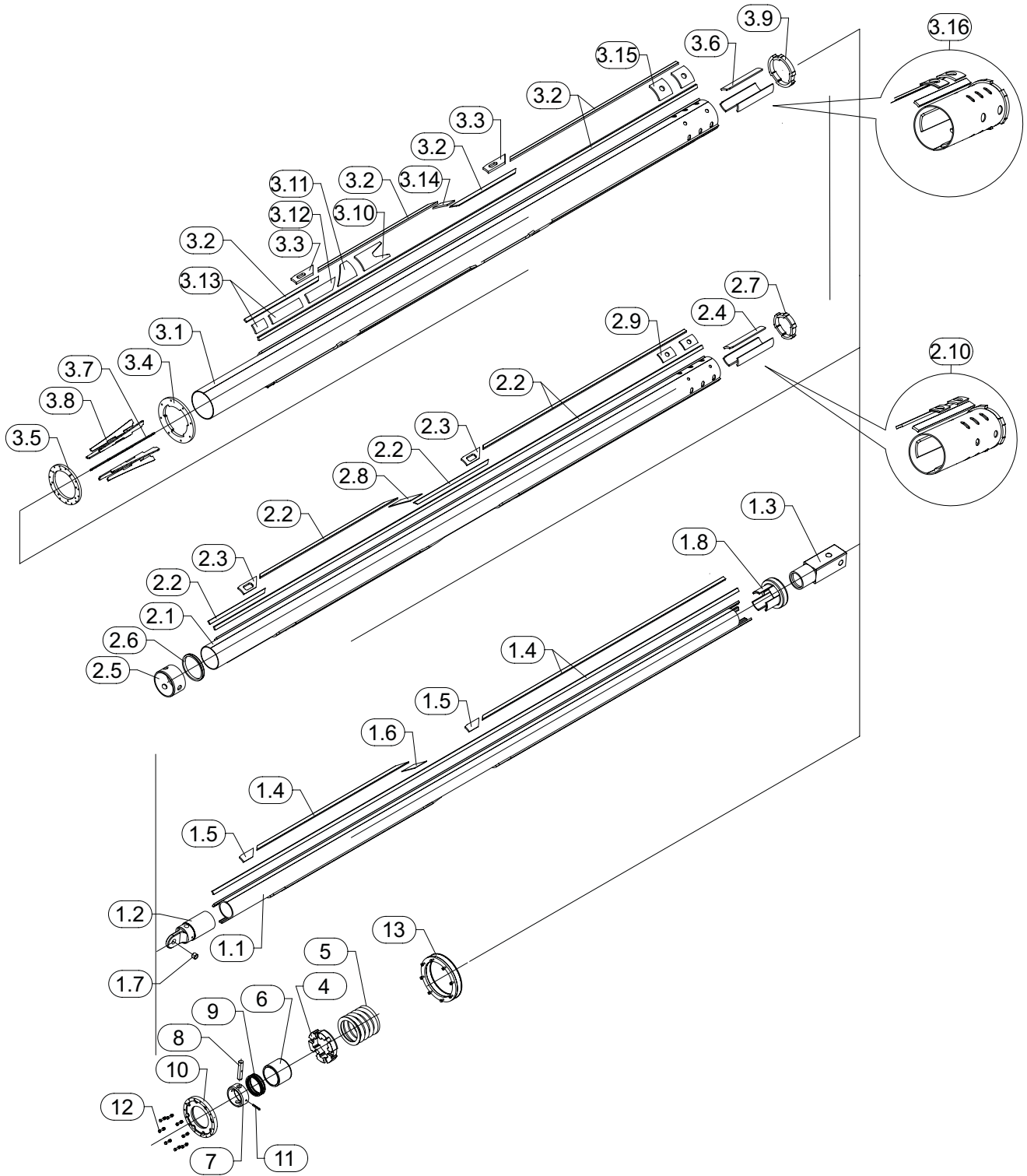

# Kelly BK170/343/3/XX-S

## Kelly Bar

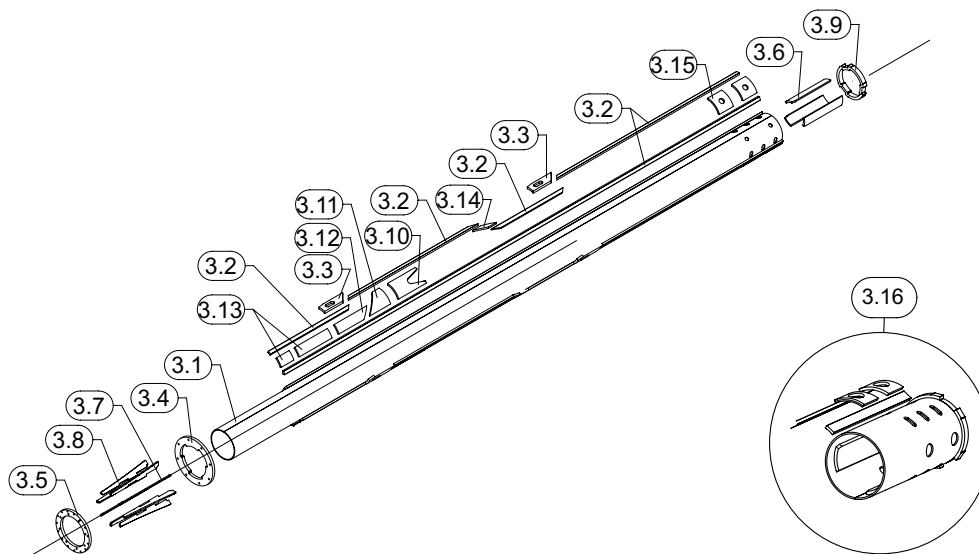

### Außenkelly kpl. | Outer Kelly cpl.

Darstellung Illustration	Bauer-Best.Nr. Bauer Item No.	Bezeichnung Description	Menge (Stck.) Quantity (pcs.)
3.1	51662	Rund-Hohlprofil nahtlos 343-8,8   Round Hollow Sec. Seamless	1*
3.2	1018282	Profilstahl 40 x 22   Section Steel	1*
3.3	96726	Anschlag   Stop	1*
3.4	1093668	Bodenplatte   Plate	1
3.5	1093669	Ring   Ring	1
3.6	1093680	Mitnehmerschale   Driving Shell	3
3.7	1093671	Blech   Sheet	3
3.8	1093673	Blech   Sheet	5
3.9	1093674	Kellyanfänger s+b   Kelly End	1
3.10	399682	Stützschale   Shell	3
3.11	402916	Stützschale   Shell	3
3.12	389935	Stützschale   Shell	3
3.13	389872	Stützschale   Shell	6
3.14	1402820	Schrägsegment   Shell	1*
3.15	1093670	Endschale   End Husk	6
3.16	1100095	Kellyanfänger kpl.   Kelly End cpl.	1
3.17	1103360	Schalldämmplatte 343   Sound Absorber	1*
3.18	1103359	Blechplatte 343   Sheet	1*
3.19	47052	Bandstahl B: 20, S: 3   Steel Strip W: 20, T: 3	1*

# Kelly BK170/343/3/XX-S

## Kelly Bar

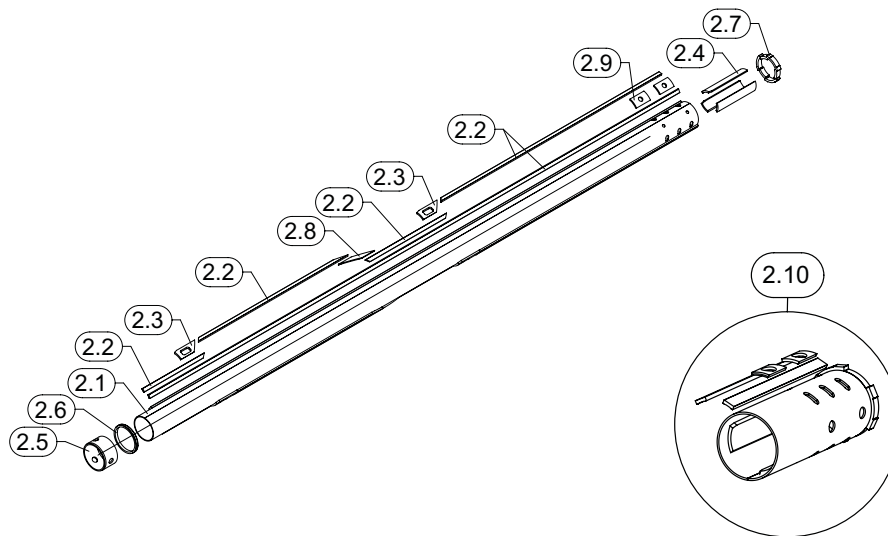

Mittelkelly kpl.   Mid Kelly cpl.			
Darstellung Illustration	Bauer-Best.Nr. Bauer Item No.	Bezeichnung Description	Menge (Stck.) Quantity (pcs.)
2.1	427918	Stahlrohr nahtlos 279-8   Tube Seamless	1*
2.2	1007811	Profilstahl 40 x 18   Section Steel	1*
2.3	369263	Anschlag Druckseite   Stop Pressure Side	1*
2.4	1093863	Mitnehmerschale   Driving Shell	3
2.5	369093	Zentrierring   Center Ring	1
2.6	369092	Verschleißring   Wear Ring	2
2.7	1093868	Kellyanfänger   Kelly End	1
2.8	1403316	Schrägsegment   Shell	1*
2.9	1093869	Endschale   End Husk	6
2.10	1100154	Kellyanfänger kpl.   Kelly End cpl.	1

# Kelly BK170/343/3/XX-S

## Kelly Bar

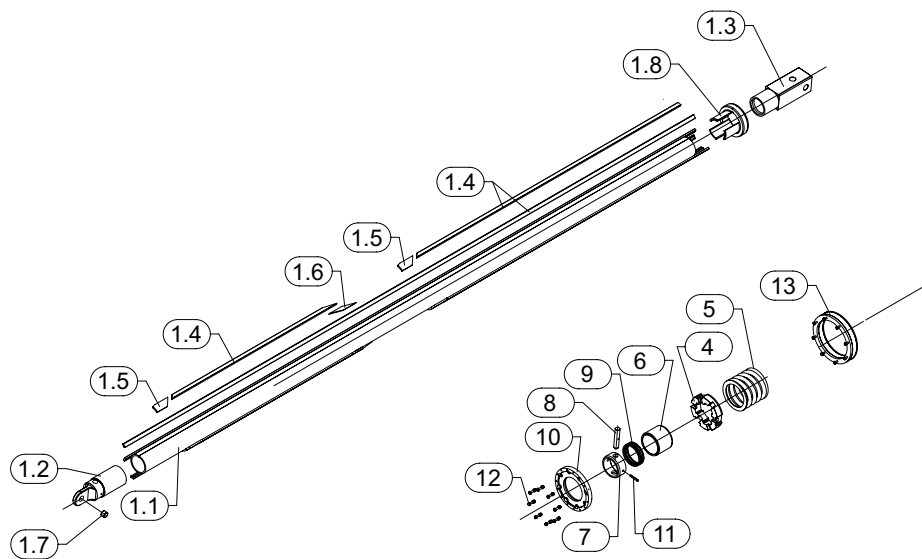

Innenkelly kpl.   Inner Kelly cpl.			
Darstellung Illustration	Bauer-Best.Nr. Bauer Item No.	Bezeichnung Description	Menge (Stck.) Quantity (pcs.)
1.1	388111	Stahlrohr nahtlos 216-14,2   Tube Seamless	1*
1.2	1093961	Anfangsstange   Initial Rod	1
1.3	370710	Vierkant 200   Square	1
1.4	1007811	Profilstahl 40 x 18   Section Steel	1*
1.5	1403734	Schrägsegment   Shell	1*
1.6	1039073	Schrägsegment-MK   Shell	1*
1.7	32177	Einspannbuchse f. Lagerungen 50 x 40   Tension Bushing int. Application	1
1.8	370711	Muffe   Sleeve	1
4.0	370827	Druckplatte   Pressure Plate	1
5.0	370674	Schraubendruckfeder 42 x 310 x 344   Spring	1
6.0	369012	Zentrierring   Center Ring	1
7.0	369015	Hülse   Sleeve	1
8.0	369014	Bolzen 50-234 OK   Pin	1
9.0	368951	Ring   Ring	3
10.0	1094174	Deckel   Cover	1
11.0	35576	Spannstift schwer 16 x 100   Spring Pin Heavy	1
12.0	1094317	Verschraubung   Screwing	8
13.0	1098495	Dämpfer kpl.   Damper cpl.	1

# Kelly BK200/368/3/XX-S

## Kelly Bar

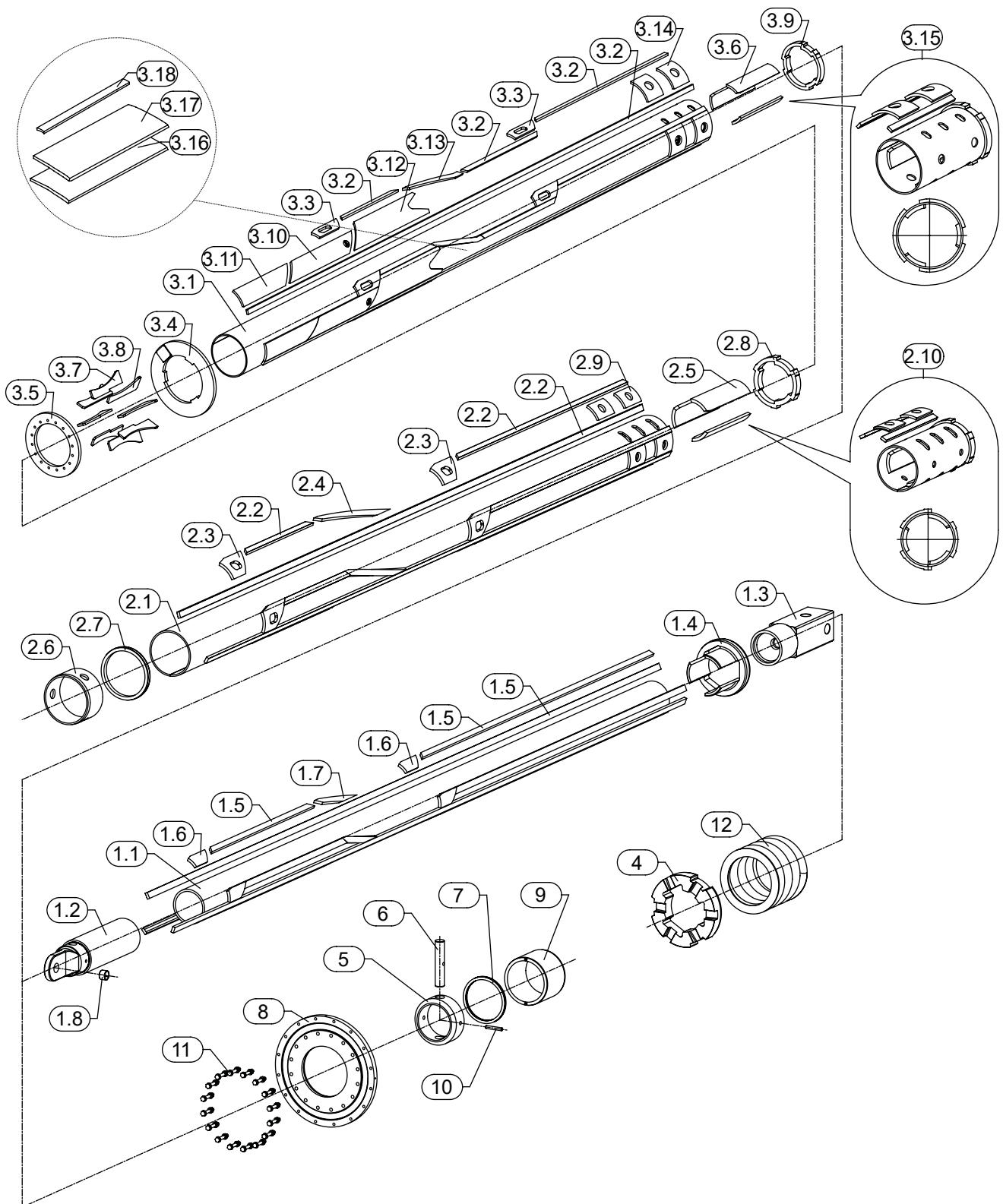

# Kelly BK200/368/3/XX-S

## Kelly Bar

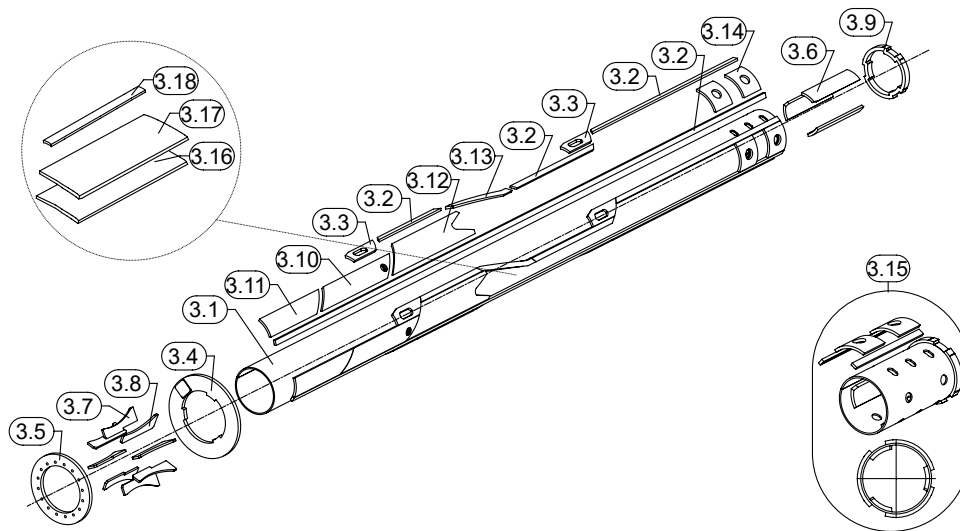

### Außenkelly kpl. | Outer Kelly cpl.

Darstellung Illustration	Bauer-Best.Nr. Bauer Item No.	Bezeichnung Description	Menge (Stck.) Quantity (pcs.)
3.1	491474	Rohr   Pipe	1
3.2	1007811	Profilstahl   Section Steel	1*
3.3	112456	Anschlag   Stop	1*
3.4	124293	Ring   Ring	1
3.5	718656	Ring   Ring	1
3.6	737986	Mitnehmerschale   Driving Shell	3
3.7	1056990	Blech   Sheet	4
3.8	749635	Blech   Sheet	4
3.9	738070	Kellyanfänger   Kelly End	1
3.10	1057407	Stützschale   Shell	3
3.11	1057406	Stützschale   Shell	3
3.12	723829	Stützschale   Shell	3
3.13	1057510	Schrägsegment   Shell	1*
3.14	1057408	Endschale   End Husk	6
3.15	1072450	Kellyanfänger kpl.   Kelly End cpl.	1
3.16	959851	Schalldämmplatte   Plate	1*
3.17	959852	Blech   Sheet	1*
3.18	47052	Bandstahl   Band Steel	1

# Kelly BK200/368/3/XX-S

## Kelly Bar

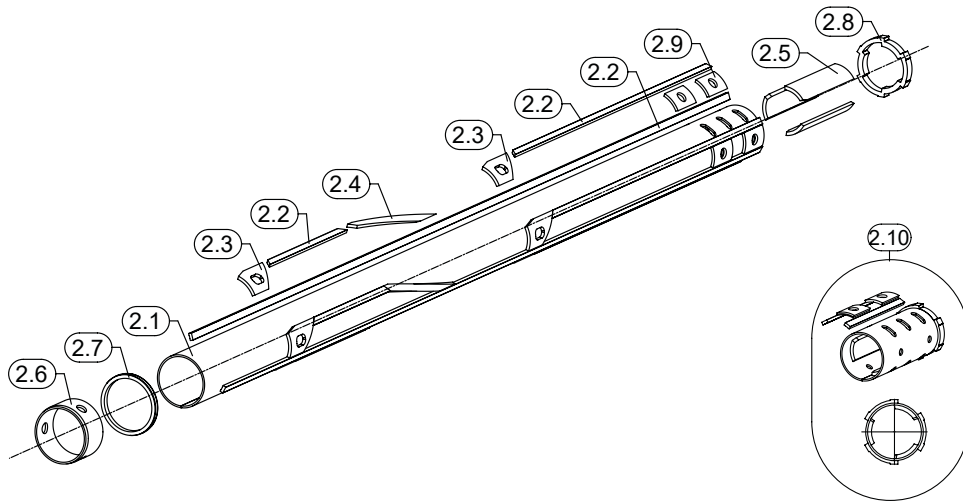

Mittelkelly kpl. | Mid Kelly cpl.

Darstellung Illustration	Bauer-Best.Nr. Bauer Item No.	Bezeichnung Description	Menge (Stck.) Quantity (pcs.)
2.1	47582	Rohr   Pipe	1*
2.2	1007811	Profilstahl   Steel	1*
2.3	112450	Anschlag   Stop	1*
2.4	1061841	Schrägsegment   Shell	1*
2.5	825815	Mitnehmerschale   Driving Shell	3
2.6	1120326	Zentrierring   Center Ring	1
2.7	1120324	Verschleißring   Ring	1
2.8	802865	Kellyanfänger   Kelly End	1
2.9	1062544	Endschale   End Husk	6
2.10	1072501	Kellyanfänger kpl.   Kelly End cpl.	1

# Kelly BK200/368/3/XX-S

## Kelly Bar

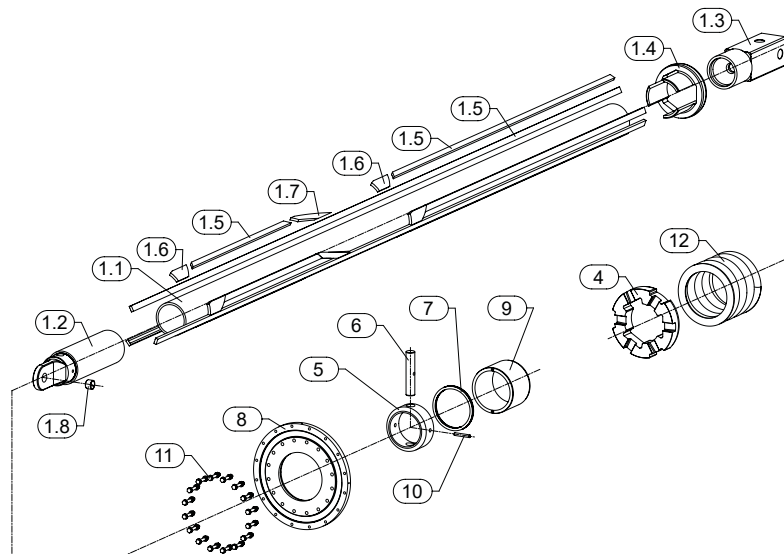

Innenkelly kpl.   Inner Kelly cpl.			
Darstellung Illustration	Bauer-Best.Nr. Bauer Item No.	Bezeichnung Description	Menge (Stck.) Quantity (pcs.)
1.1	390554	Rohr   Pipe	1
1.2	113740	Anfangsstange   Rod	1
1.3	113726	Vierkant   Square	1
1.4	113742	Führungsring   Guiding Ring	1
1.5	1007811	Profilstahl   Steel	1*
1.6	112449	Anschlag   Stop	1*
1.7	1061930	Schrägsegment   Shell	1*
1.8	32177	Einspannbuchse   Tension Bushing	1
4.0	113741	Druckplatte   Plate	1
5.0	113754	Hülse   Sleeve	1
6.0	113755	Bolzen   Pin	1
7.0	113756	Ring   Ring	3
8.0	733077	Deckel   Cover	1
9.0	113762	Zentrierring   Center Ring	1
10.0	35576	Spannstift   Pin	1
11.0	718925	Verschraubung   Screwing	16
12.0	275761	Schraubendruckfeder   Spring	1

# Kelly BK200/368/4/XX-S

## Kelly Bar

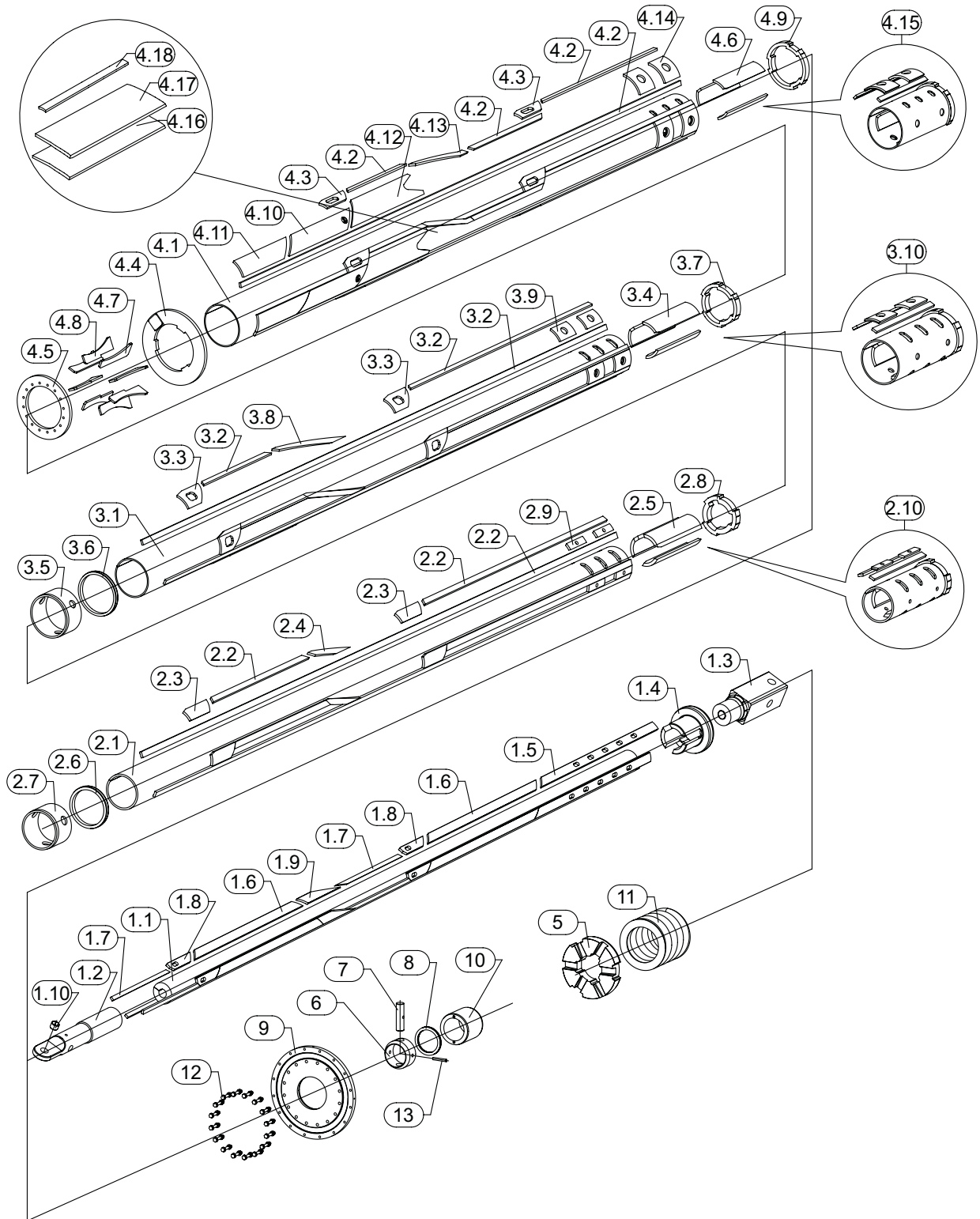

# Kelly BK200/368/4/XX-S

## Kelly Bar

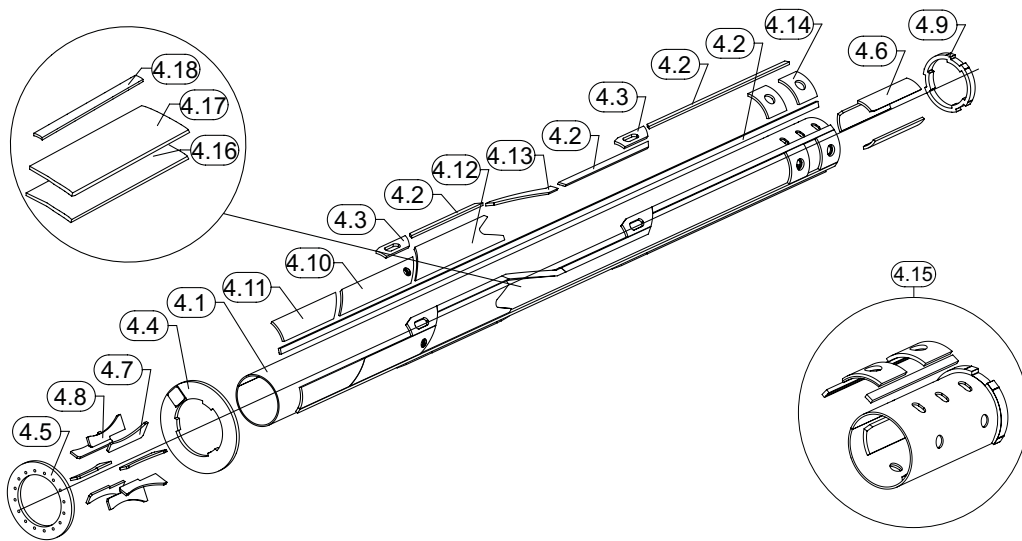

Außenkelly kpl.   Outer Kelly cpl.			
Darstellung Illustration	Bauer-Best.Nr. Bauer Item No.	Bezeichnung Description	Menge (Stck.) Quantity (pcs.)
4.1	491474	Rund-Hohlprofil nahtlos 368-10   Round Hollow Sec. Seamless	1*
4.2	1007811	Profilstahl 40 x 18   Section Steel	1*
4.3	112456	Anschlag Druckseite   Stop Pressure Side	1*
4.4	124293	Scheibe   Disk/Washer	1
4.5	718656	Deckel   Cover	1
4.6	718698	Mitnehmerschale   Driving Shell	3
4.7	749635	Blech   Sheet	4
4.8	1056990	Blech   Sheet	4
4.9	718703	Kellyanfänger   Kelly End	1
4.10	1057407	Stützschale   Shell	3
4.11	1057406	Stützschale   Shell	3
4.12	723829	Stützschale   Shell	3
4.13	1057510	Schrägsegment-AK   Shell	1*
4.14	1057408	Endschale   End Husk	6
4.15	1072614	Kellyanfänger kpl. 368, L: 1500   Kelly End cpl.	1
4.16	959851	Schalldämmplatte 368   Sound Absorber	1*
4.17	959852	Blechplatte 368   Sheet	1*
4.18	47052	Bandstahl B: 20, S: 3   Steel Strip W: 20, T: 3	1*

# Kelly BK200/368/4/XX-S

## Kelly Bar

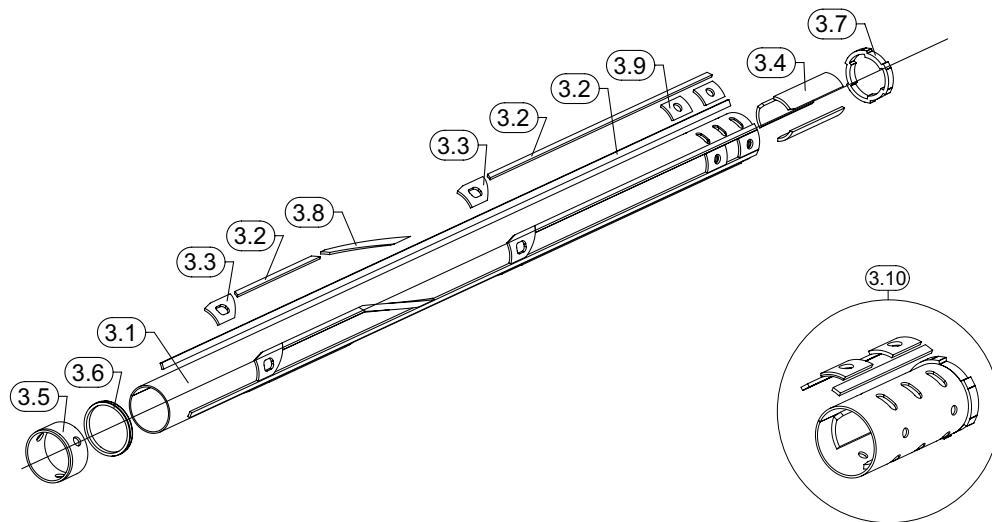

Zwischenkelly kpl.   Intermediate Kelly cpl.			
Darstellung Illustration	Bauer-Best.Nr. Bauer Item No.	Bezeichnung Description	Menge (Stck.) Quantity (pcs.)
3.1	751179	Rund-Hohlprofil nahtlos 305-10   Round Hollow Sec. Seamless	1*
3.2	1058267	Profilstahl 40 x 15   Section Steel	1*
3.3	718227	Anschlag   Stop	1*
3.4	718346	Mitnehmerschale   Driving Shell	3
3.5	413467	Zentrierring   Center Ring	1
3.6	718233	Verschleißring   Wear Ring	1
3.7	718231	Kellyanfänger   Kelly End	1
3.8	1057530	Schrägsegment-ZK   Shell	1*
3.9	1057734	Endschale   End Husk	6
3.10	1072502	Kellyanfänger kpl. 305, L: 1500   Kelly End cpl.	1

# Kelly BK200/368/4/XX-S

## Kelly Bar

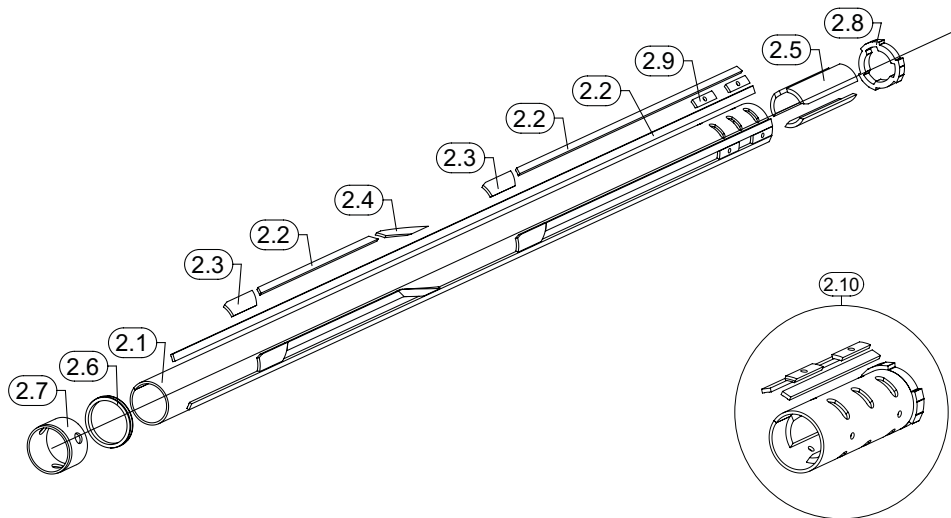

Mittelkelly kpl.   Mid Kelly cpl.			
Darstellung Illustration	Bauer-Best.Nr. Bauer Item No.	Bezeichnung Description	Menge (Stck.) Quantity (pcs.)
2.1	406427	Stahlrohr nahtlos 241-12,5   Tube Seamless	1*
2.2	1058267	Profilstahl 40 x 15   Section Steel	1*
2.3	718697	Anschlag Druckseite   Stop Pressure Side	1*
2.4	1058535	Schrägsegment-MK   Shell	1*
2.5	718741	Mitnehmerschale   Driving Shell	3
2.6	718743	Verschleißring   Wear Ring	1
2.7	413392	Zentrierring   Center Ring	1
2.8	718761	Kellyanfänger   Kelly End	1
2.9	1058536	Endschale   End Husk	6
2.10	1072503	Kellyanfänger kpl. 241, L: 1500   Kelly End cpl.	1

# Kelly BK200/368/4/XX-S

## Kelly Bar

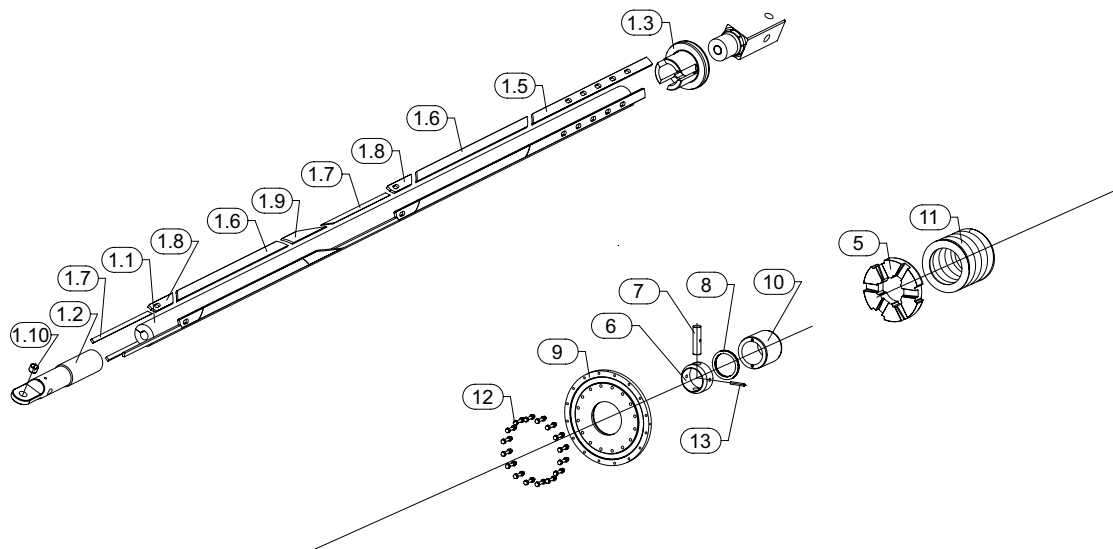

Innenkelly kpl.   Inner Kelly cpl.			
Darstellung Illustration	Bauer-Best.Nr. Bauer Item No.	Bezeichnung Description	Menge (Stck.) Quantity (pcs.)
1.1	406428	Stahlrohr nahtlos 168-50   <a href="#">Tube Seamless</a>	1*
1.2	413388	Anfangsstange   <a href="#">Initial Rod</a>	1
1.3	413389	Vierkant 200   <a href="#">Square</a>	1
1.4	717744	Muffe   <a href="#">Sleeve</a>	1
1.5	750637	Profilstahl   <a href="#">Section Steel</a>	3
1.6	1052137	Profilstahl 70 x 18   <a href="#">Section Steel</a>	1*
1.7	47818	Profilstahl 30 x 17   <a href="#">Section Steel</a>	1*
1.8	984803	Anschlag Druckseite   <a href="#">Stop Pressure Side</a>	1*
1.9	1051990	Schrägsegment-IK   <a href="#">Shell</a>	1*
1.10	32177	Einspannbuchse f. Lagerungen 50 x 40   <a href="#">Tension Bushing int. Application</a>	1
5.0	718767	Druckplatte   <a href="#">Pressure Plate</a>	1
6.0	112459	Buchse   <a href="#">Bushing</a>	1
7.0	767327	Bolzen 50-177 OK   <a href="#">Pin</a>	1
8.0	112507	Ring   <a href="#">Ring</a>	3
9.0	718857	Deckel   <a href="#">Cover</a>	1
10.0	112509	Zentrierring   <a href="#">Center Ring</a>	1
11.0	78423	Schraubendruckfeder   <a href="#">Spring</a>	1
12.0	718925	Verschraubung   <a href="#">Screwing</a>	16
13.0	35576	Spannstift schwer 16 x 100   <a href="#">Spring Pin Heavy</a>	1



# Kelly BK250/394/4/XX-S

## Kelly Bar

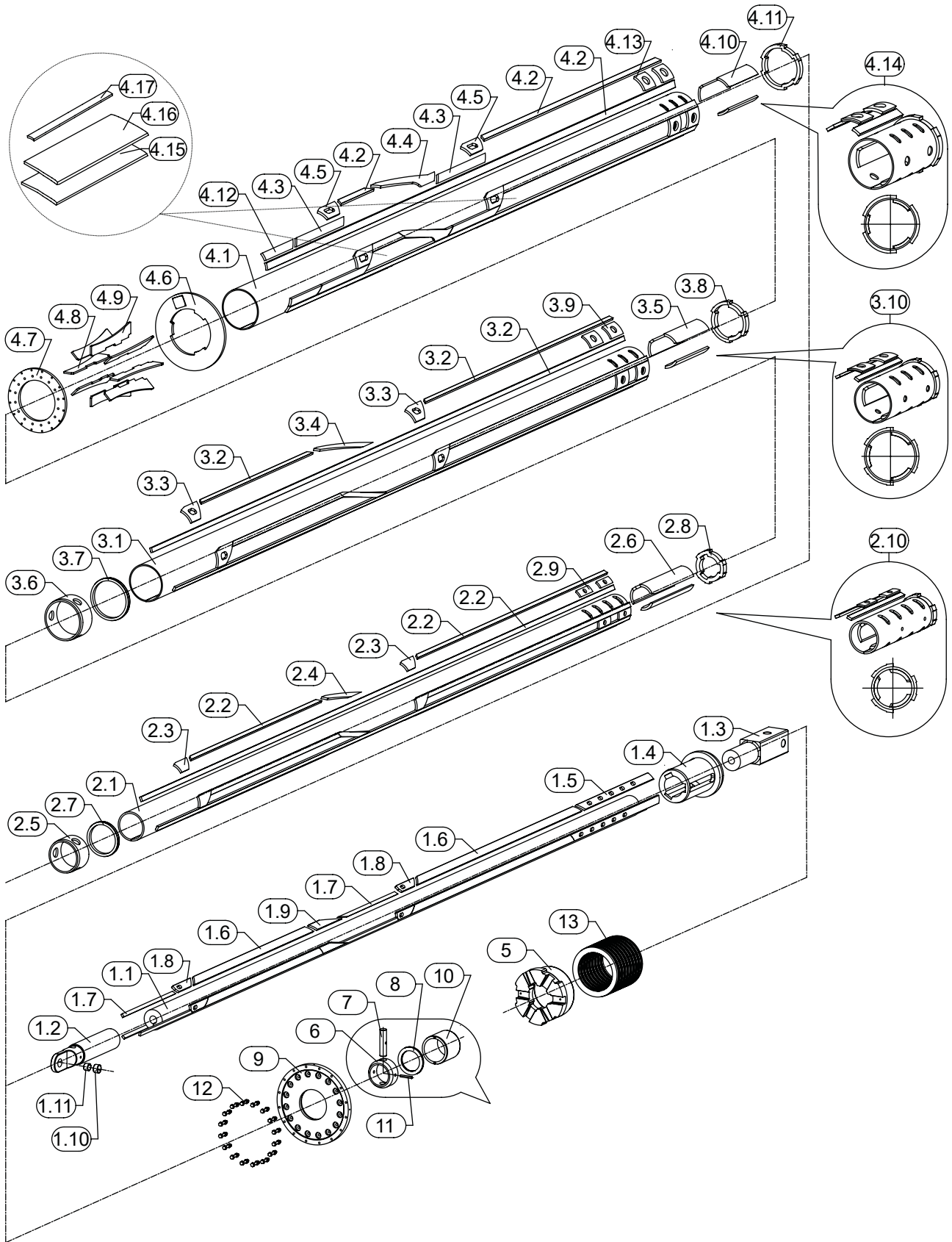

# Kelly BK250/394/4/XX-S

## Kelly Bar

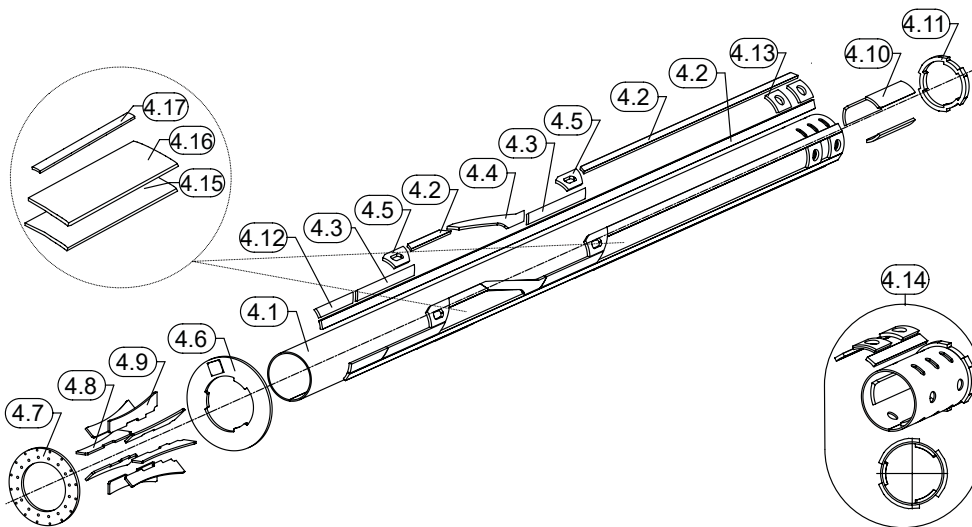

Außenkelly kpl.   Outer Kelly cpl.			
Darstellung Illustration	Bauer-Best.Nr. Bauer Item No.	Bezeichnung Description	Menge (Stck.) Quantity (pcs.)
4.1	1037570	Rohr   Pipe	1
4.2	1007871	Profilstahl   Steel	1*
4.3	1049631	Stützschale   Shell	1*
4.4	1049632	Schrägsegment   Shell	1*
4.5	101395	Anschlag   Stop	1*
4.6	71977	Ring   Ring	1
4.7	792262	Ring   Ring	1
4.8	1049633	Blech   Sheet	4
4.9	1049634	Blech   Sheet	4
4.10	793656	Mitnehmerschale   Driving Shell	3
4.11	790652	Kellyanfänger   Kelly End	1
4.12	1049639	Stützschale   Shell	3
4.13	1049638	Endschale   End Husk	6
4.14	1072445	Kellyanfänger kpl.   Kelly End cpl.	1
4.15	959739	Schalldämmplatte   Plate	1*
4.16	959740	Blech   Sheet	1*
4.17	47052	Bandstahl   Band Steel	1

# Kelly BK250/394/4/XX-S

## Kelly Bar

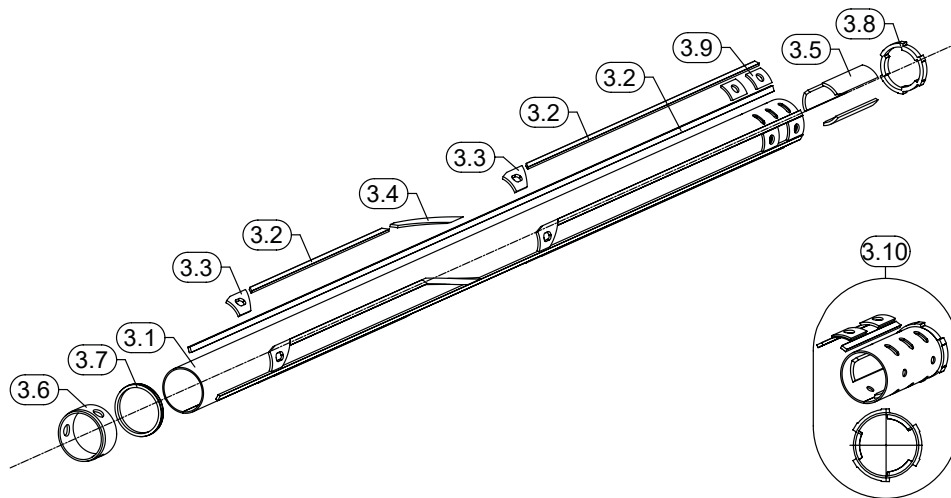

Zwischenkelly kpl.   Intermediate Kelly cpl.			
Darstellung Illustration	Bauer-Best.Nr. Bauer Item No.	Bezeichnung Description	Menge (Stck.) Quantity (pcs.)
3.1	1015152	Rohr   Pipe	1
3.2	1007811	Profilstahl   Steel	1*
3.3	101324	Anschlag   Stop	1*
3.4	1049753	Schrägsegment   Shell	1*
3.5	793657	Mitnehmerschale   Driving Shell	3
3.6	1120761	Zentrierring   Center Ring	1
3.7	1120729	Verschleißring   Ring	1
3.8	790653	Kellyanfänger   Kelly End	1
3.9	1049754	Endschale   End Husk	6
3.10	1072447	Kellyanfänger kpl.   Kelly End cpl.	1

# Kelly BK250/394/4/XX-S

## Kelly Bar

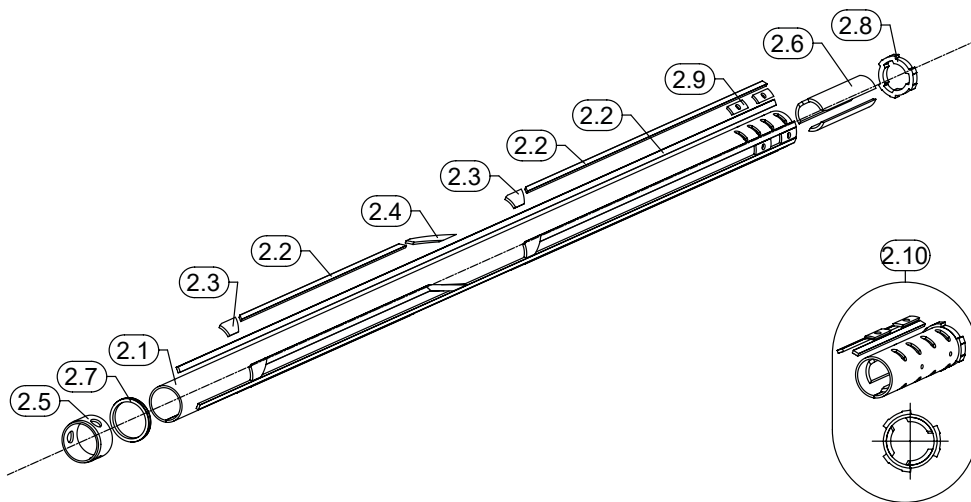

### Mittelkelly kpl. | Mid Kelly cpl.

Darstellung Illustration	Bauer-Best.Nr. Bauer Item No.	Bezeichnung Description	Menge (Stck.) Quantity (pcs.)
2.1	386067	Rohr   Pipe	1
2.2	1007811	Profilstahl   Steel	1*
2.3	101325	Anschlag   Stop	1*
2.4	1049895	Schrägsegment   Shell	1*
2.5	1120680	Zentrierring   Center Ring	1
2.6	796913	Mitnehmerschale   Driving Shell	3
2.7	1120654	Verschleißring   Ring	1
2.8	796755	Kellyanfänger   Kelly End	1
2.9	1049896	Endschale   End Husk	6
2.10	1072449	Kellyanfänger kpl.   Kelly End cpl.	1

# Kelly BK250/394/4/XX-S

## Kelly Bar

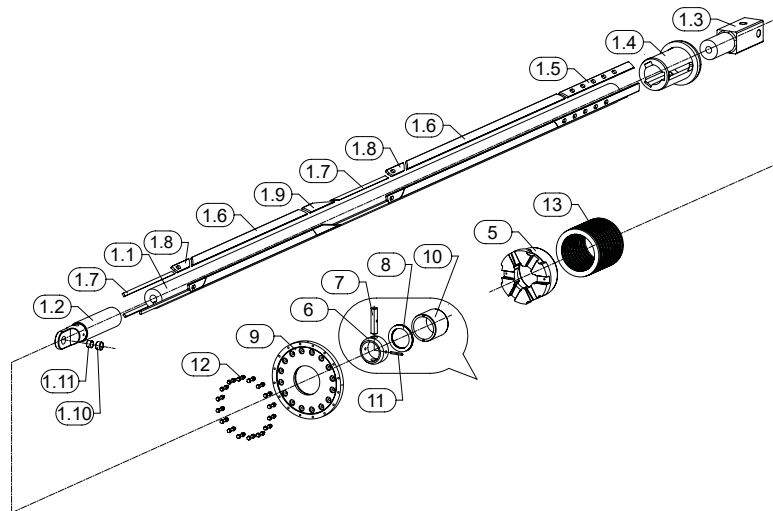

Innenkelly kpl.   Inner Kelly cpl.			
Darstellung Illustration	Bauer-Best.Nr. Bauer Item No.	Bezeichnung Description	Menge (Stck.) Quantity (pcs.)
1.1	386066	Rohr   Pipe	1
1.2	71929	Anfangsstange   Rod	1
1.3	77500	Vierkant   Square	1
1.4	221463	Führungsring   Guiding Ring	1
1.5	395285	Profilstahl   Steel	3
1.6	1052137	Profilstahl   Steel	1*
1.7	47818	Profilstahl   Steel	1*
1.8	984803	Anschlag   Stop	1*
1.9	1051990	Schrägsegment   Shell	1*
1.10	859905	Einspannbuchse   Tension Bushing	1
1.11	32177	Einspannbuchse   Tension Bushing	1
5.0	1049509	Anschlagring   Ring	1
6.0	72212	Hülse   Sleeve	1
7.0	72213	Bolzen   Pin	1
8.0	72214	Ring   Ring	3
9.0	796914	Deckel   Cover	1
10.0	77484	Zentrierring   Center Ring	1
11.0	35576	Spannstift   Pin	1
12.0	755938	Verschraubung   Screwing	16
13.0	71169	Tellerfeder   Spring	18

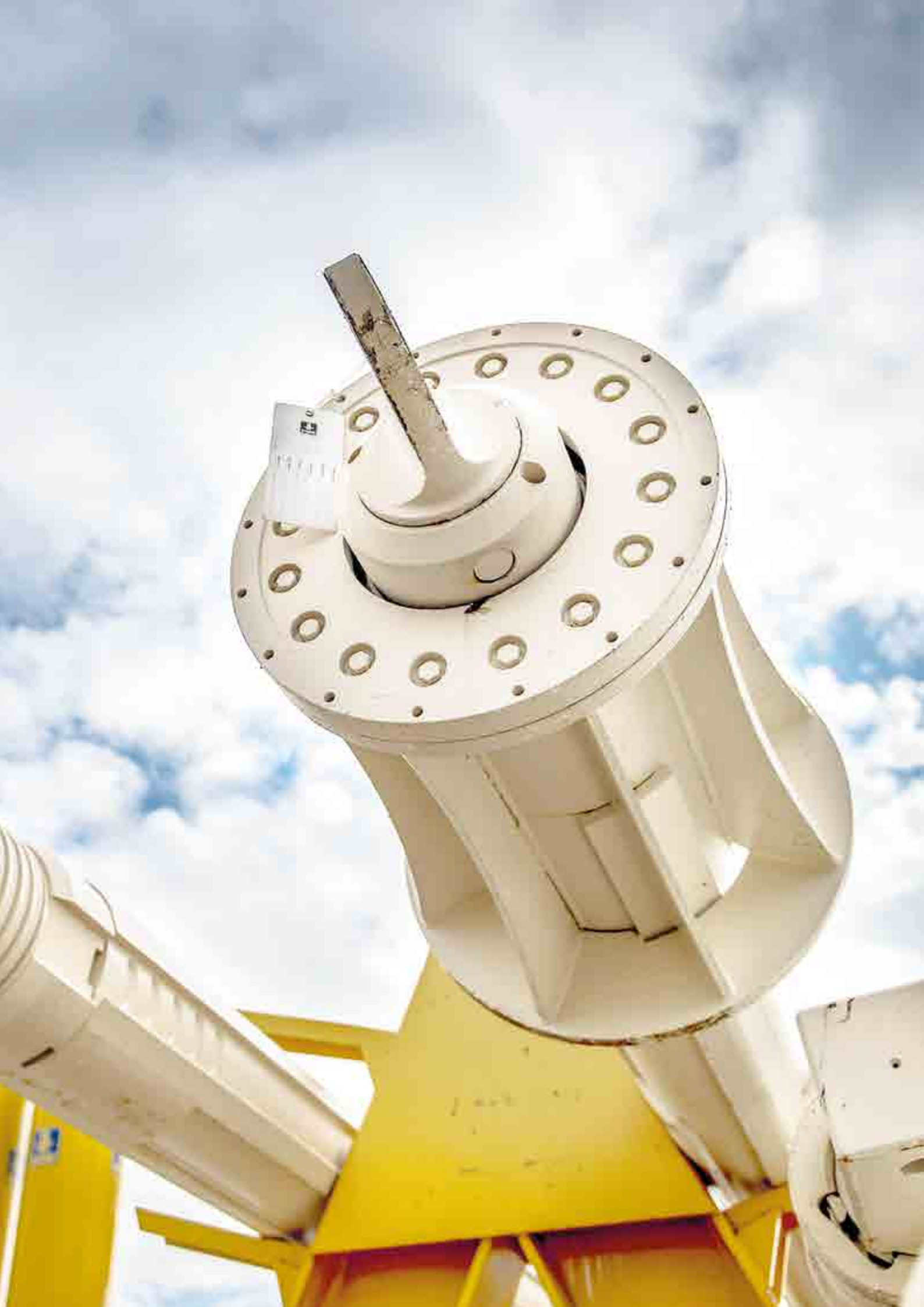

# Kelly BK260/394/3/XX-S

## Kelly Bar

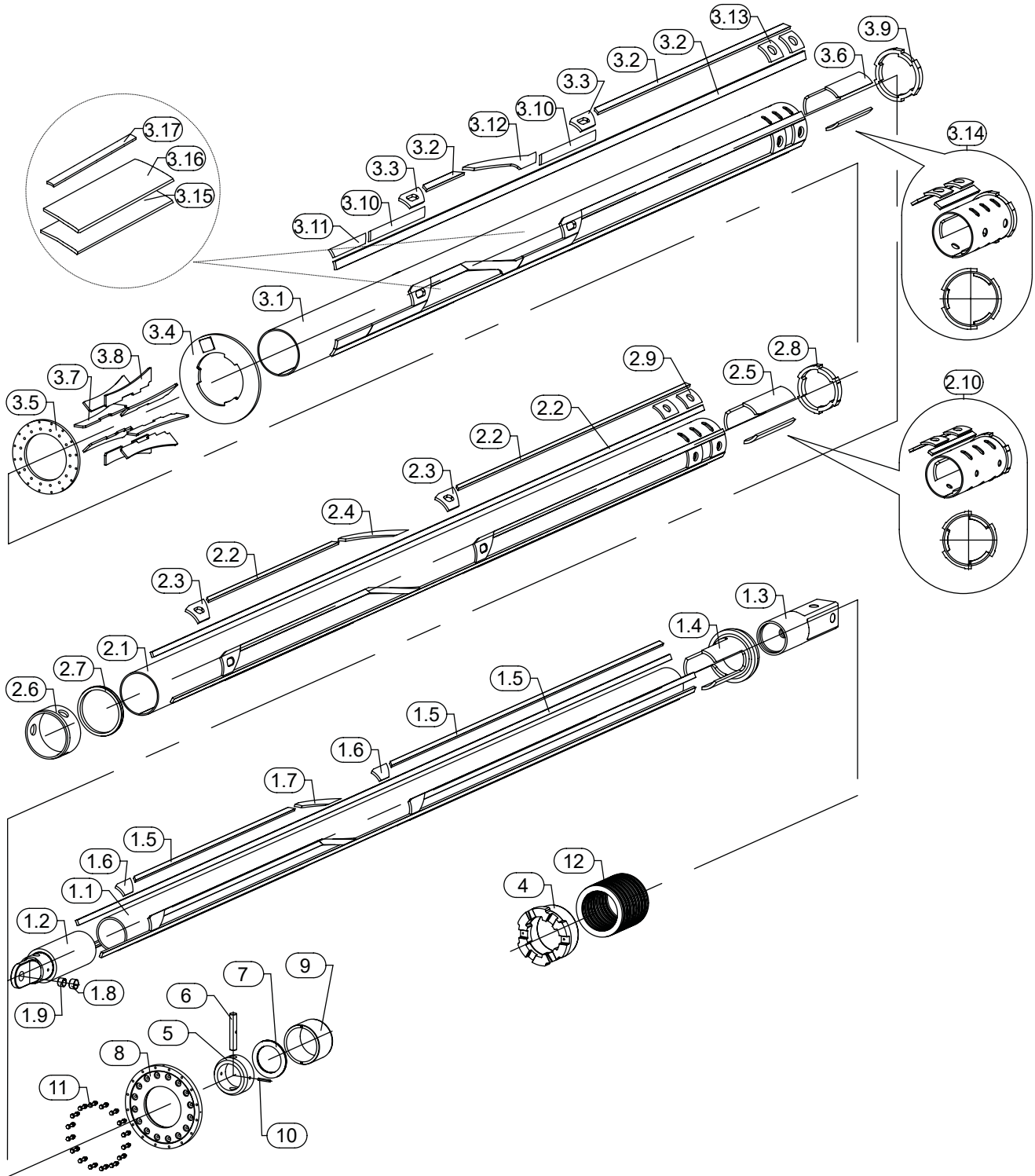

# Kelly BK260/394/3/XX-S

## Kelly Bar

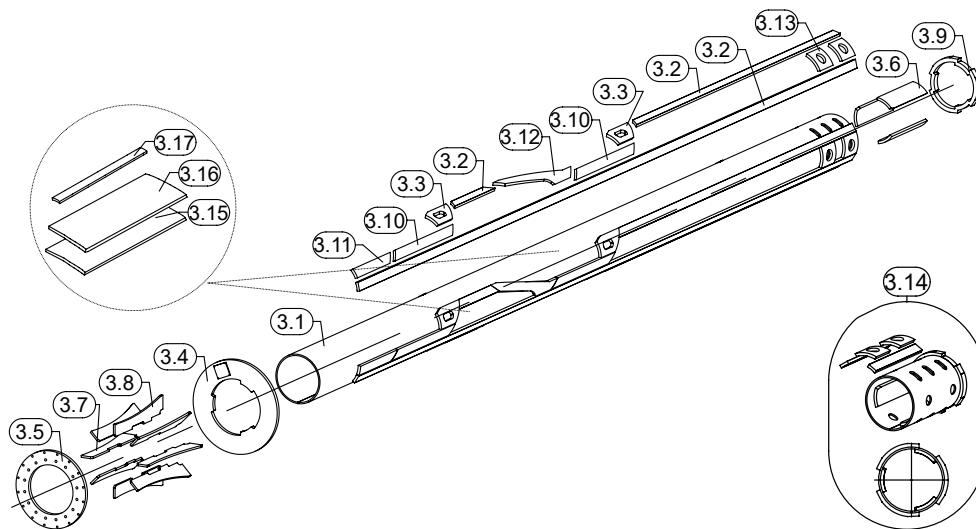

Außenkelly kpl.   Outer Kelly cpl.			
Darstellung Illustration	Bauer-Best.Nr. Bauer Item No.	Bezeichnung Description	Menge (Stck.) Quantity (pcs.)
3.1	1037570	Rohr   Pipe	1
3.2	1007871	Profilstahl   Steel	1*
3.3	101395	Anschlag   Stop	1*
3.4	71977	Ring   Ring	1
3.5	792262	Ring   Ring	1
3.6	793656	Mitnehmerschale   Driving Shell	3
3.7	1049633	Blech   Sheet	4
3.8	1049634	Blech   Sheet	4
3.9	790652	Kellyanfänger   Kelly End	1
3.10	1049631	Stützschale   Shell	1*
3.11	1049639	Stützschale   Shell	3
3.12	1049632	Schrägsegment   Shell	1*
3.13	1049638	Endschale   End Husk	6
3.14	1072445	Kellyanfänger kpl.   Kelly End cpl.	1
3.15	959739	Schalldämmplatte   Plate	1*
3.16	959740	Blech   Sheet	1*
3.17	47052	Bandstahl   Band Steel	1

# Kelly BK260/394/3/XX-S

## Kelly Bar

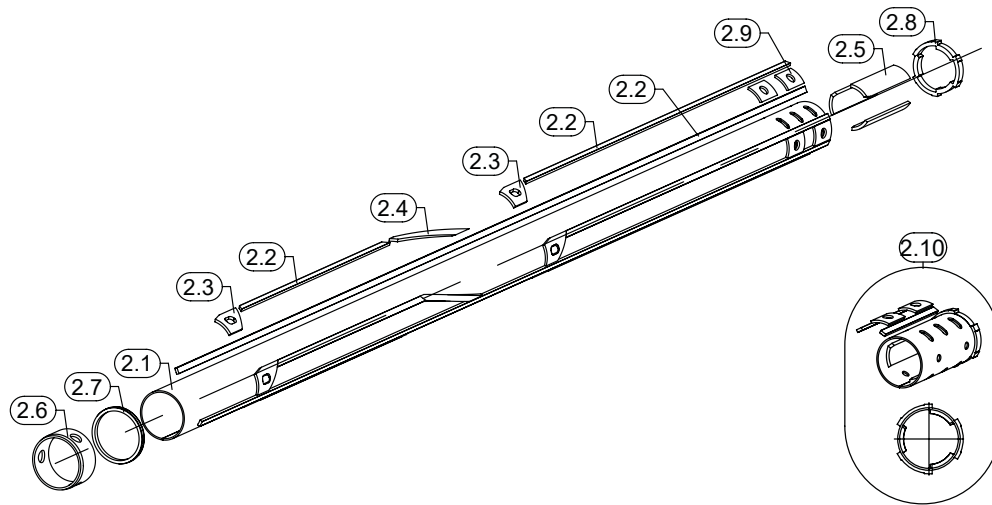

Mittelkelly kpl.   Mid Kelly cpl.			
Darstellung Illustration	Bauer-Best.Nr. Bauer Item No.	Bezeichnung Description	Menge (Stck.) Quantity (pcs.)
2.1	1015152	Rohr   Pipe	1
2.2	1007811	Profilstahl   Steel	1*
2.3	101324	Anschlag   Stop	1*
2.4	1049753	Schrägsegment   Shell	1*
2.5	793657	Mitnehmerschale   Driving Shell	3
2.6	1120761	Zentrierring   Center Ring	1
2.7	1120729	Verschleißring   Ring	1
2.8	790653	Kellyanfänger   Kelly End	1
2.9	1049754	Endschale   End Husk	6
2.10	1072447	Kellyanfänger kpl.   Kelly Starter cpl.	1

# Kelly BK260/394/3/XX-S

## Kelly Bar

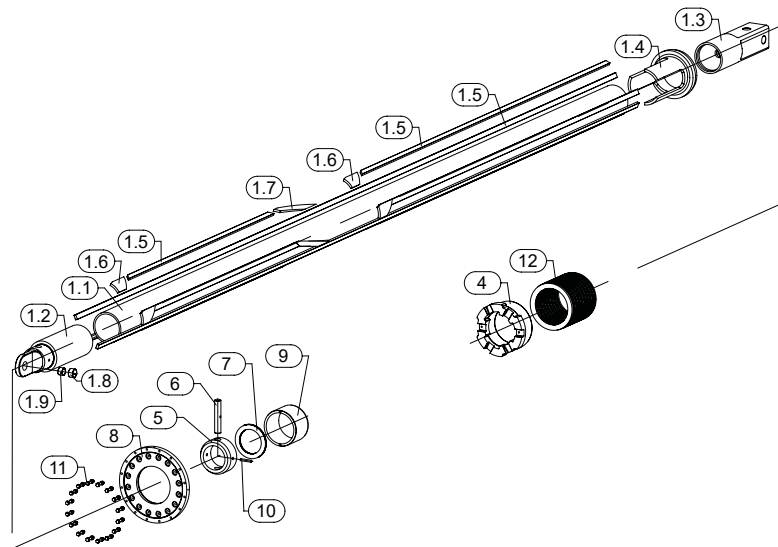

Innenkelly kpl.   Inner Kelly cpl.			
Darstellung Illustration	Bauer-Best.Nr. Bauer Item No.	Bezeichnung Description	Menge (Stck.) Quantity (pcs.)
1.1	386067	Rohr   Pipe	1
1.2	77583	Anfangsstange   Rod	1
1.3	77584	Vierkant   Square	1
1.4	77585	Führungsring   Guiding Ring	1
1.5	1007811	Profilstahl   Steel	1*
1.6	101325	Anschlag   Stop	1*
1.7	1049895	Schrägsegment   Shell	1*
1.8	859905	Einspannbuchse   Tension Bushing	1
1.9	32177	Einspannbuchse   Tension Bushing	1
4.0	1050070	Anschlagring   Ring	1
5.0	72739	Hülse   Sleeve	1
6.0	72740	Bolzen   Pin	1
7.0	72741	Ring   Ring	3
8.0	755887	Deckel   Cover	1
9.0	77580	Zentrierring   Center Ring	1
10.0	35576	Spannstift   Pin	1
11.0	755938	Verschraubung   Screwing	16
12.0	71169	Tellerfeder   Spring	18

# Kelly BK280/419/4/XX-S

## Kelly Bar

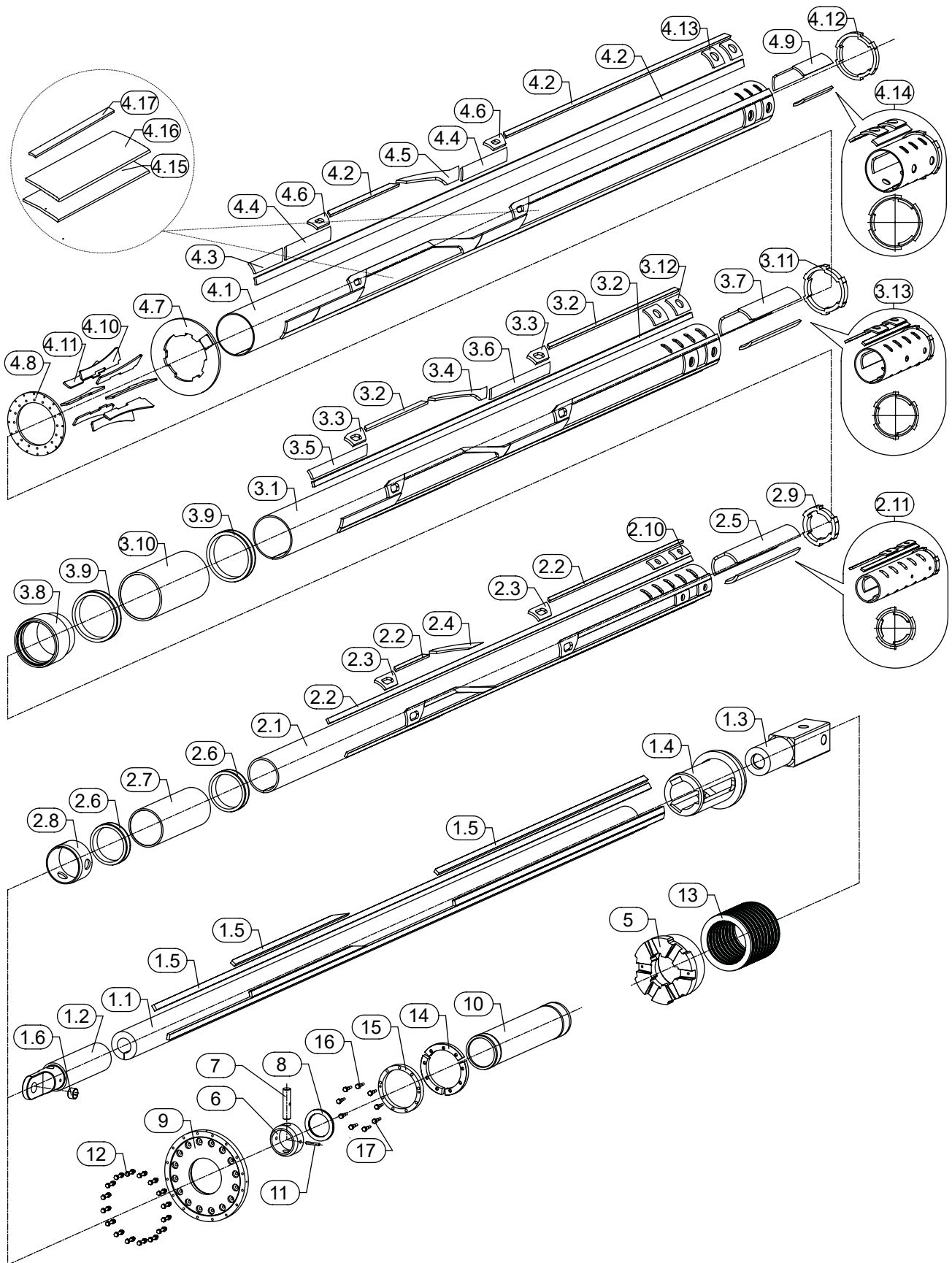

# Kelly BK280/419/4/XX-S

## Kelly Bar

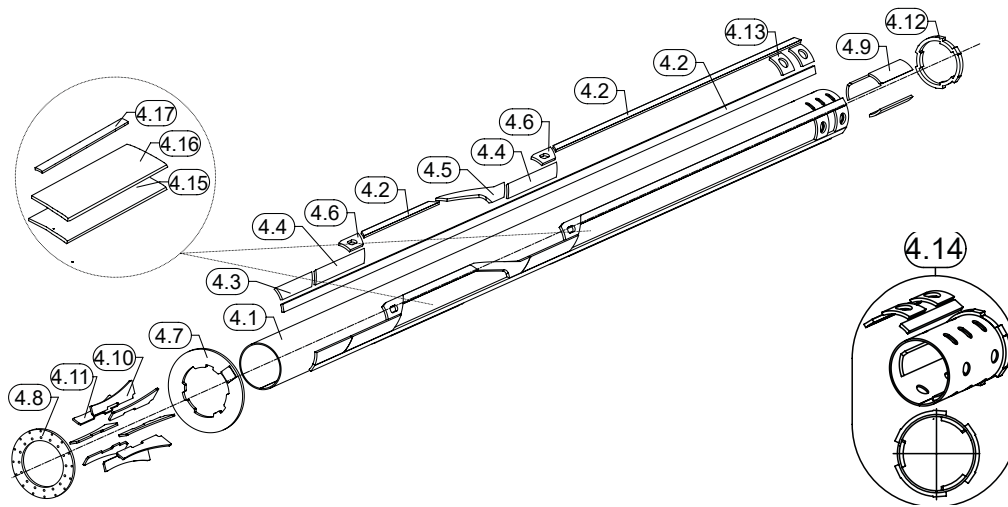

Außenkelly kpl.   Outer Kelly cpl.			
Darstellung Illustration	Bauer-Best.Nr. Bauer Item No.	Bezeichnung Description	Menge (Stck.) Quantity (pcs.)
4.1	1038001	Rohr   Pipe	1
4.2	1007871	Profilstahl   Steel	1*
4.3	1048146	Stützschale   Shell	3
4.4	1048145	Stützschale   Shell	1*
4.5	1048404	Schrägsegment   Shell	1*
4.6	398625	Anschlag   Stop	1*
4.7	1048093	Ring   Ring	1
4.8	755384	Ring   Ring	1
4.9	742545	Mitnehmerschale   Driving Shell	3
4.10	1048094	Blech   Sheet	4
4.11	1048095	Blech   Sheet	4
4.12	742544	Kellyanfänger kpl.   Kelly Starter cpl.	1
4.13	1048147	Endschale   End Husk	6
4.14	1072403	Kellyanfänger   Kelly End	1
4.15	959737	Schalldämmplatte   Plate	1*
4.16	959738	Blech   Sheet	1*
4.17	47052	Bandstahl   Band Steel	1

# Kelly BK280/419/4/XX-S

## Kelly Bar

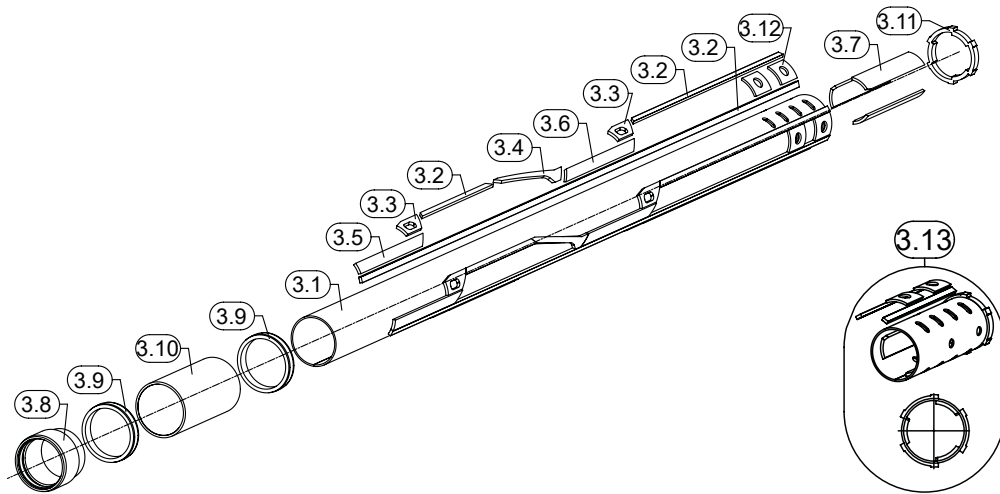

Zwischenkelly kpl.   Intermediate Kelly cpl.			
Darstellung Illustration	Bauer-Best.Nr. Bauer Item No.	Bezeichnung Description	Menge (Stck.) Quantity (pcs.)
3.1	1037987	Rohr   Pipe	1
3.2	1018271	Profilstahl   Steel	1*
3.3	451729	Anschlag   Stop	1*
3.4	1048215	Schrägsegment   Shell	1*
3.5	1053496	Stützschale   Shell	3
3.6	1048380	Stützschale   Shell	1*
3.7	442714	Mitnehmerschale   Driving Shell	3
3.8	446324	Anschweißbuchse   Bush	1
3.9	443330	Verschleißring   Ring	2
3.10	438726	Zwischenrohr   Pipe	1
3.11	451770	Kellyanfänger kpl.   Kelly Starter cpl.	1
3.12	1048216	Endschale   End Husk	6
3.13	1072404	Kellyanfänger kpl.   Kelly End cpl.	1

# Kelly BK280/419/4/XX-S

## Kelly Bar

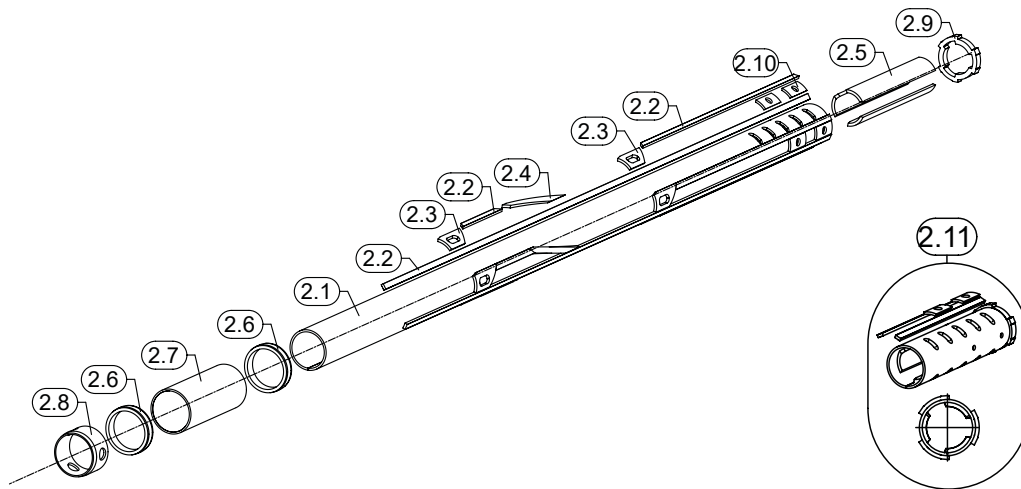

Mittelkelly kpl.   Mid Kelly cpl.			
Darstellung Illustration	Bauer-Best.Nr. Bauer Item No.	Bezeichnung Description	Menge (Stck.) Quantity (pcs.)
2.1	1037985	Rohr   Pipe	1
2.2	1007811	Profilstahl   Steel	1*
2.3	398650	Anschlag   Stop	1*
2.4	1048291	Schrägsegment   Shell	1*
2.5	442715	Mitnehmerschale   Driving Shell	3
2.6	443400	Verschleißring   Ring	2
2.7	438660	Zwischenrohr   Pipe	1
2.8	398597	Zentrierring   Center Ring	1
2.9	437311	Kellyanfänger kpl.   Kelly Starter cpl.	1
2.10	1048292	Endschale   End Husk	6
2.11	1072444	Kellyanfänger   Kelly End	1

# Kelly BK280/419/4/XX-S

## Kelly Bar

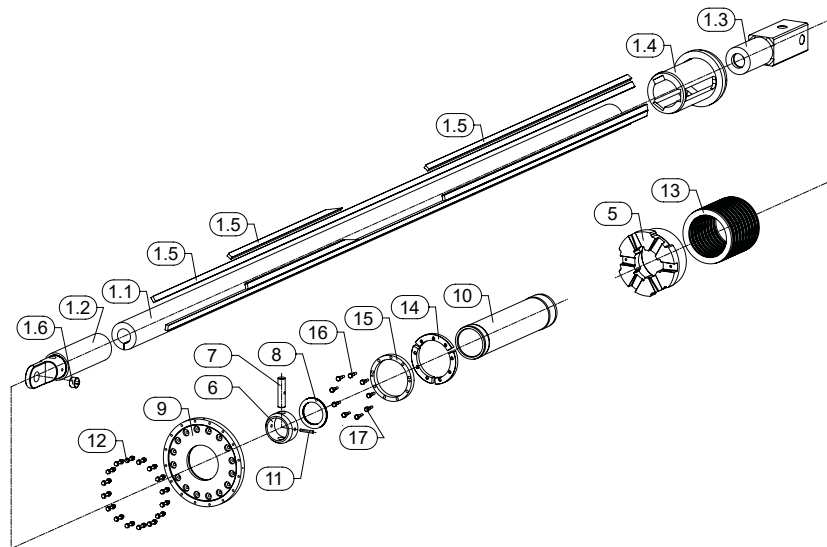

Innenkelly kpl.   Inner Kelly cpl.			
Darstellung Illustration	Bauer-Best.Nr. Bauer Item No.	Bezeichnung Description	Menge (Stck.) Quantity (pcs.)
1.1	395713	Rohr   Pipe	1
1.2	396503	Anfangsstange   Rod	1
1.3	396504	Vierkant   Square	1
1.4	396505	Führungsring   Guiding Ring	1
1.5	1018271	Profilstahl   Steel	1*
1.6	859905	Einspannbuchse   Tension Bushing	1
5.0	1047980	Anschlagring   Ring	1
6.0	72212	Hülse   Sleeve	1
7.0	72213	Bolzen   Bolt	1
8.0	72214	Ring   Ring	3
9.0	797304	Deckel   Cover	1
10.0	445534	Zentrierrohr   Pipe	1
11.0	35576	Spannstift   Pin	1
12.0	755938	Verschraubung   Screwing	16
13.0	71169	Tellerfeder   Spring	18
14.0	446325	Ringsegment   Ring	3
15.0	446326	Ring   Ring	1
16.0	201987	Scheibe   Disk	9
17.0	45260	Sechskantschraube   Screw	9



# Kelly BK300/419/3/XX-S

## Kelly Bar

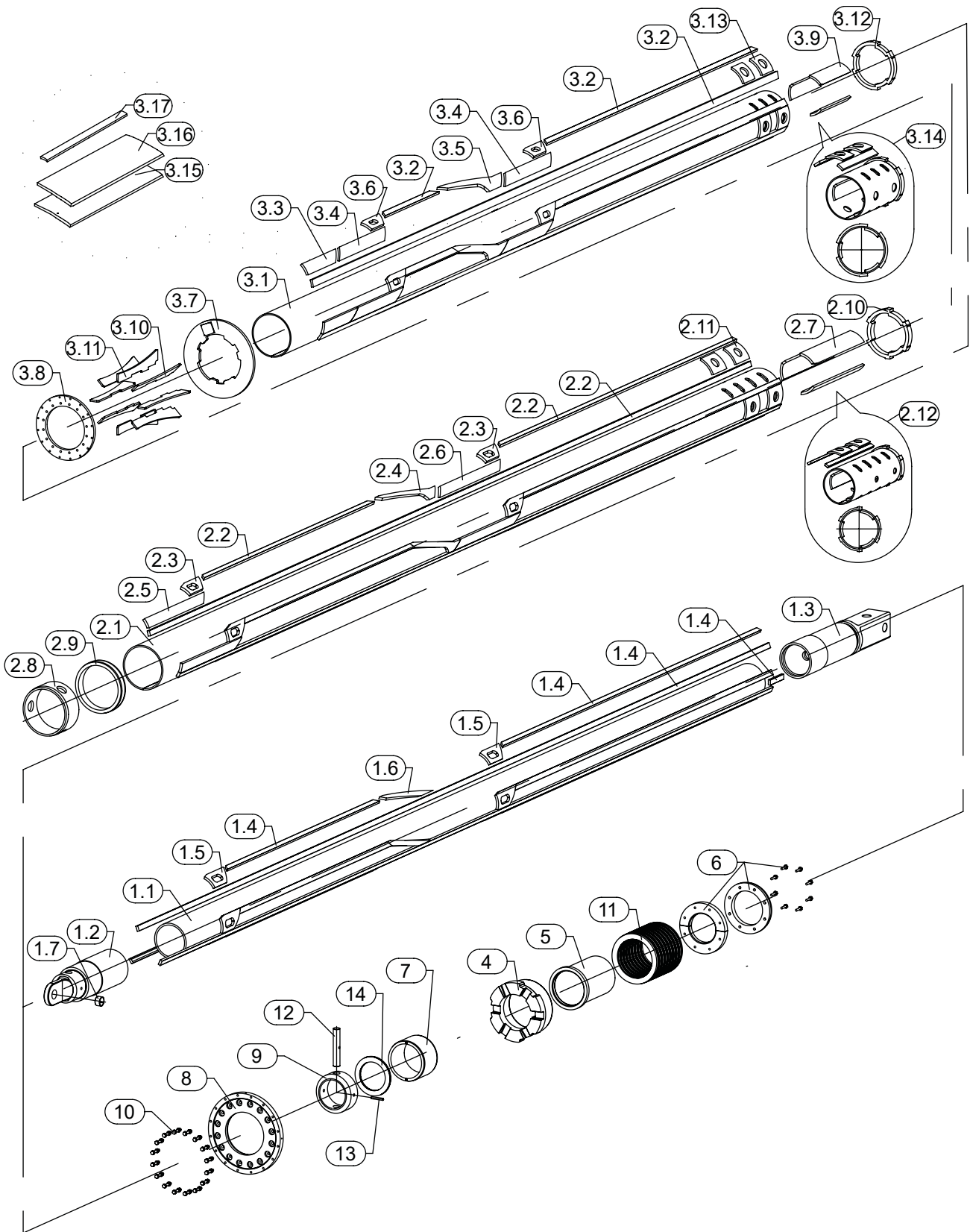

# Kelly BK300/419/3/XX-S

## Kelly Bar

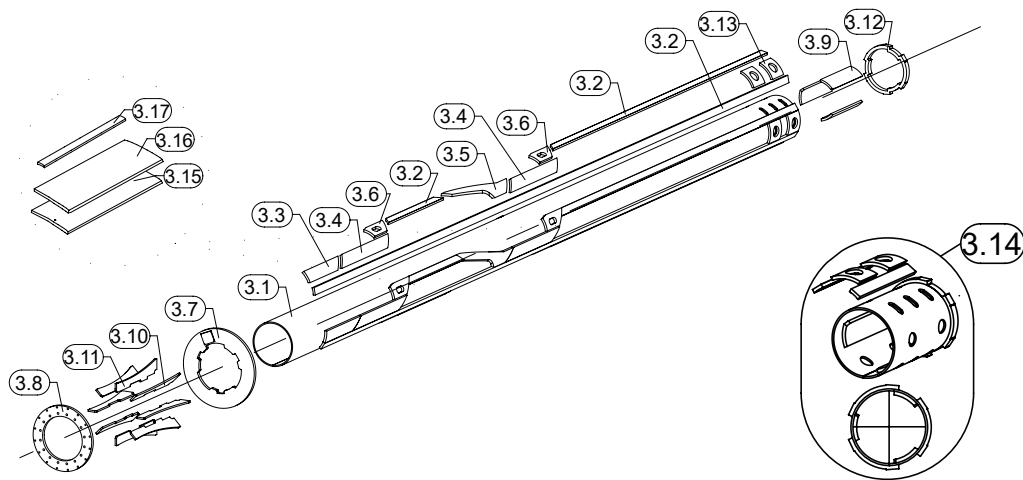

Außenkelly kpl.   Outer Kelly cpl.			
Darstellung Illustration	Bauer-Best.Nr. Bauer Item No.	Bezeichnung Description	Menge (Stck.) Quantity (pcs.)
3.1	1038001	Rohr   Pipe	1
3.2	1007871	Profilstahl   Steel	1*
3.3	1048146	Stützschale   Shell	3
3.4	1048145	Stützschale   Shell	1*
3.5	1048404	Schrägsegment   Shell	1*
3.6	398625	Anschlag   Stop	1*
3.7	1048093	Ring   Ring	1
3.8	755384	Ring   Ring	1
3.9	742545	Mitnehmerschale   Driving Shell	3
3.10	1048094	Blech   Sheet	4
3.11	1048095	Blech   Sheet	4
3.12	742544	Kellyanfänger   Kelly End	1
3.13	1048147	Endschale   End Husk	6
3.14	1072403	Kellyanfänger kpl.   Kelly Starter cpl.	1
3.15	959737	Schalldämmplatte   Plate	1*
3.16	959738	Blech   Sheet	1*
3.17	47052	Bandstahl   Band Steel	1

# Kelly BK300/419/3/XX-S

## Kelly Bar

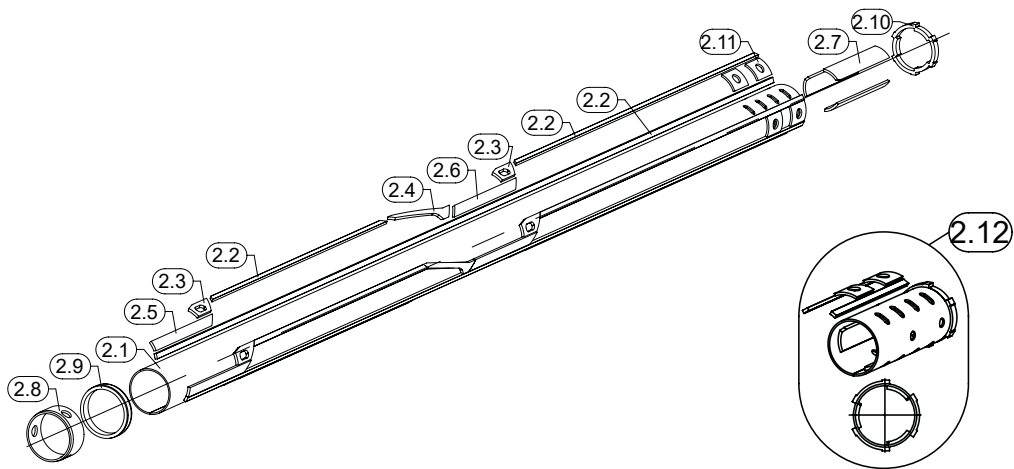

Mittelkelly kpl.   Mid Kelly cpl.			
Darstellung Illustration	Bauer-Best.Nr. Bauer Item No.	Bezeichnung Description	Menge (Stck.) Quantity (pcs.)
2.1	1037987	Rohr   Pipe	1
2.2	1018271	Profilstahl   Steel	1*
2.3	451729	Anschlag Druckseite   Stop	1*
2.4	1048215	Schrägsegment   Shell	1*
2.5	1053496	Stützschale   Shell	3
2.6	1048380	Stützschale   Shell	1*
2.7	442714	Mitnehmerschale   Driving Shell	3
2.8	398632	Zentrierring   Center Ring	1
2.9	443330	Verschleißring   Ring	1
2.10	451770	Kellyanfänger   Kelly End	1
2.11	1048216	Endschale   End Husk	6
2.12	1072404	Kellyanfänger kpl.   Kelly Starter cpl.	1

# Kelly BK300/419/3/XX-S

## Kelly Bar

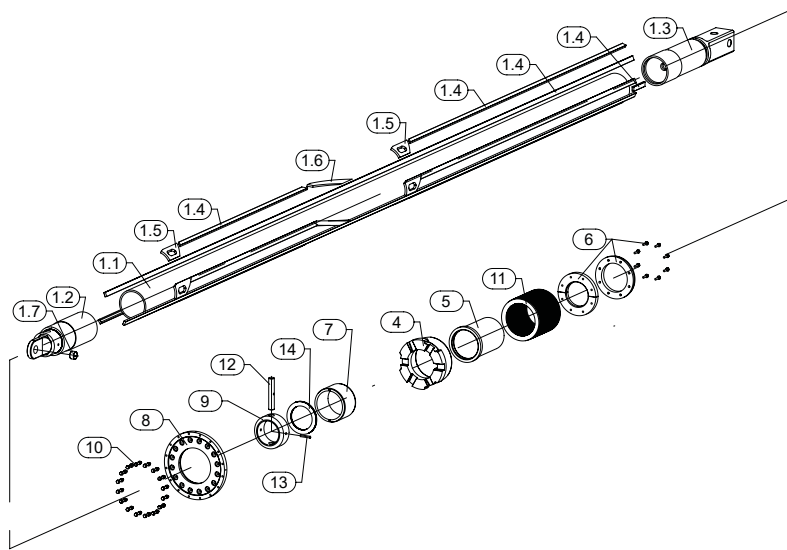

### Innenkelly kpl. | Inner Kelly cpl.

Darstellung Illustration	Bauer-Best.Nr. Bauer Item No.	Bezeichnung Description	Menge (Stck.) Quantity (pcs.)
1.1	1037985	Rohr   Pipe	1
1.2	399604	Anfangsstange   Rod	1
1.3	399575	Vierkant   Square	1
1.4	1007811	Profilstahl   Steel	1*
1.5	398650	Anschlag Druckseite   Stop	1*
1.6	1048291	Schrägsegment   Shell	1*
1.7	859905	Einspannbuchse   Tension Bushing	1
4.0	1040008	Anschlagring   Ring	1
5.0	399789	Hülse   Sleeve	1
6.0	792876	Ring kpl.   Ring cpl.	1
7.0	399891	Zentrierring   Center Ring	1
8.0	792811	Deckel   Cover	1
9.0	399892	Hülse   Sleeve	1
10.0	755938	Verschraubung   Screwing	16
11.0	71169	Tellerfeder   Spring	18
12.0	399984	Bolzen   Bolt	1
13.0	35576	Spannstift   Pin	1
14.0	403347	Ring   Ring	3

# Kelly BK420/470/3/XX-S

## Kelly Bar

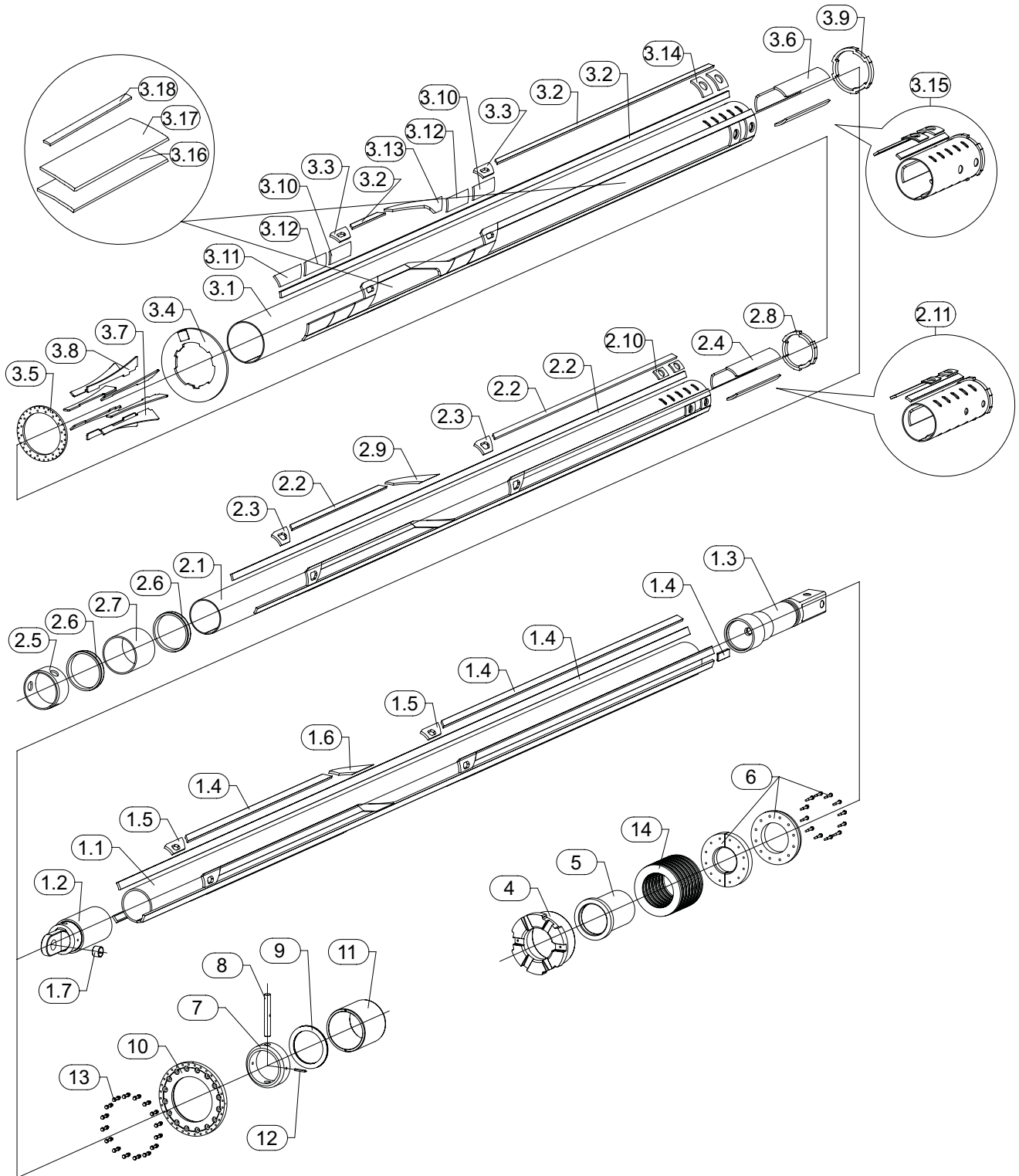

# Kelly BK420/470/3/XX-S

## Kelly Bar

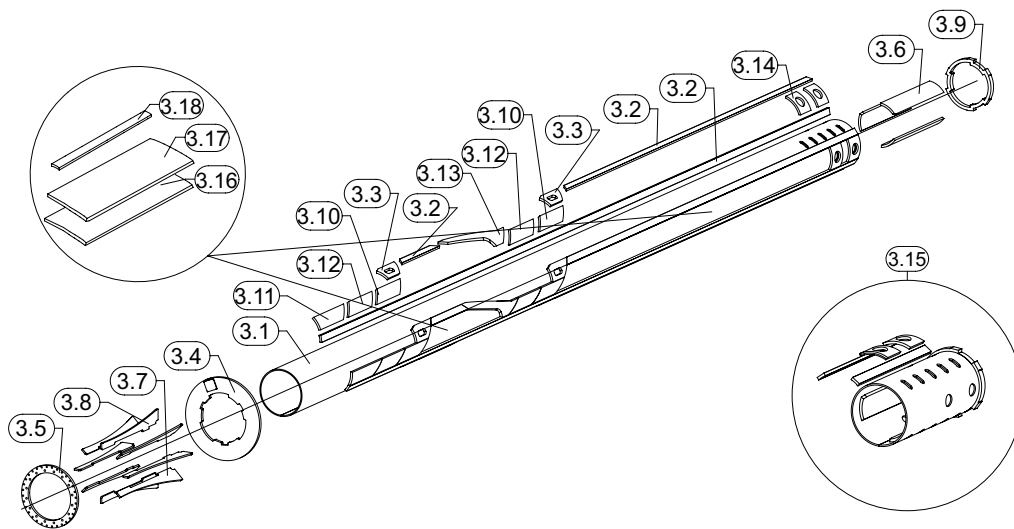

Außenkelly kpl.   Outer Kelly cpl.			
Darstellung Illustration	Bauer-Best.Nr. Bauer Item No.	Bezeichnung Description	Menge (Stck.) Quantity (pcs.)
3.1	1037990	Rund-Hohlprofil geschweißt 470-11   Round Hollow Sec. Welded	1
3.2	1007871	Profilstahl 70 x 22   Section Steel	1*
3.3	100159	Anschlag   Stop	1*
3.4	1038620	Ring   Ring	1
3.5	779040	Ring   Ring	1
3.6	779070	Mitnehmerschale   Driving Shell	3
3.7	1038651	Blech   Sheet	5
3.8	1038652	Blech   Sheet	3
3.9	779041	Kellyanfänger   Kelly End	1
3.10	1038713	Stützschale   Shell	1*
3.11	1038714	Stützschale   Shell	3
3.12	1044749	Stützschale   Shell	1*
3.13	1038712	Schrägsegment-AK   Shell	1*
3.14	1038619	Endschale   End Husk	6
3.15	1071710	Kellyanfänger kpl. 470, L: 1500   Kelly End cpl.	1
3.16	959734	Schalldämmplatte 470   Sound Absorber	1*
3.17	959733	Blechplatte 470   Sheet	1*
3.18	47052	Bandstahl B: 20, S: 3   Steel Strip W: 20, T: 3	1

# Kelly BK420/470/3/XX-S

## Kelly Bar

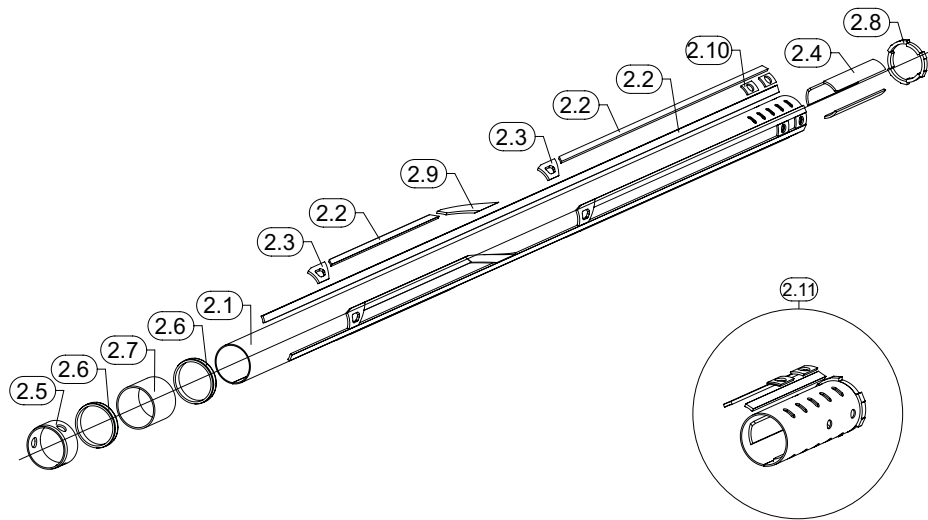

Mittelkelly kpl.   Mid Kelly cpl.			
Darstellung Illustration	Bauer-Best.Nr. Bauer Item No.	Bezeichnung Description	Menge (Stck.) Quantity (pcs.)
2.1	1037570	Rund-Hohlprofil geschweißt 394-11   Round Hollow Sec. Selded	1
2.2	1007871	Profilstahl 70 x 22   Section Steel	1*
2.3	101200	Anschlag Druckseite   Stop Pressure Side	1*
2.4	101198	Mitnehmerschale   Driving Shell	3
2.5	101223	Zentrierring   Center Ring	1
2.6	455591	Verschleißring   Wear Ring	2
2.7	455783	Zwischenrohr Ø 428, L: 400   Intermediate Tube	1
2.8	101226	Kellyanfänger   Kelly End	1
2.9	1038456	Schrägsegment-ZK   Shell	1*
2.10	1038337	Endschale   End Husk	6
2.11	1072401	Kellyanfänger kpl. 394, L: 1500   Kelly End cpl.	1

# Kelly BK420/470/3/XX-S

## Kelly Bar

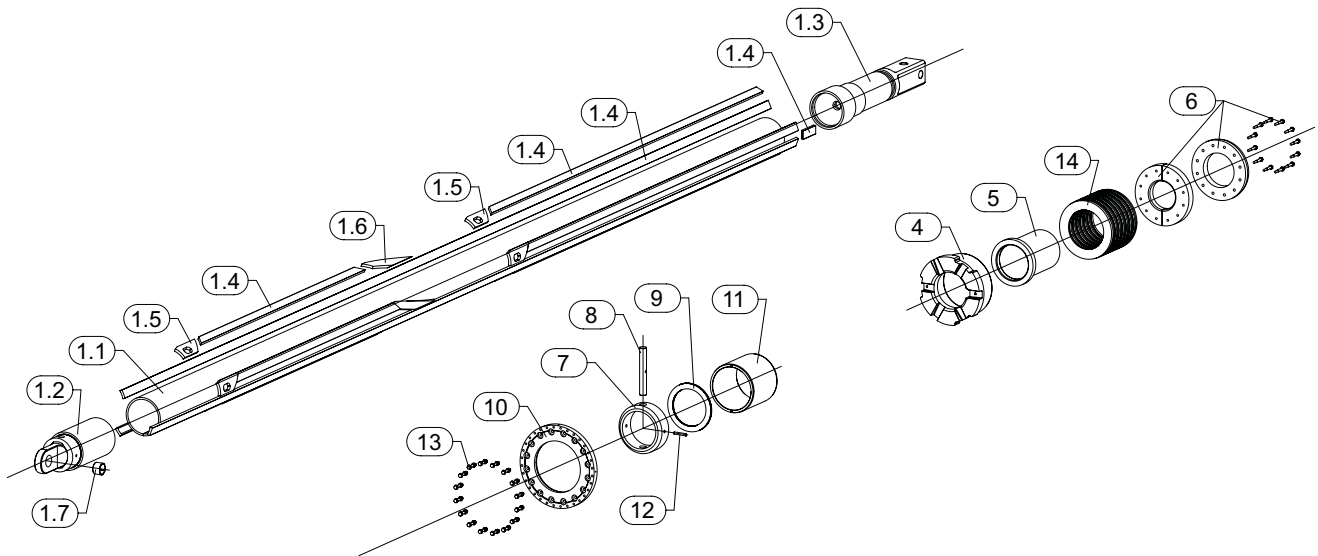

### Innenkelly kpl. | Inner Kelly cpl.

Darstellung Illustration	Bauer-Best.Nr. Bauer Item No.	Bezeichnung Description	Menge (Stck.) Quantity (pcs.)
1.1	417892	Stahlrohr nahtlos 318-16   <a href="#">Tube Seamless</a>	1*
1.2	865130	Anfangsstange   <a href="#">Initial Rod</a>	1
1.3	121048	Vierkant 200   <a href="#">Square</a>	1
1.4	1007871	Profilstahl 70 x 22   <a href="#">Section Steel</a>	1*
1.5	101199	Anschlag Druckseite   <a href="#">Stop Pressure Side</a>	1*
1.6	1039073	Schrägsegment-MK   <a href="#">Shell</a>	1*
1.7	859903	Einspannbuchse   <a href="#">Tension Bushing</a>	1
4.0	1040331	Anschlagring   <a href="#">End Stop Ring</a>	1
5.0	116634	Hülse   <a href="#">Sleeve</a>	1
6.0	798085	Ring kpl.   <a href="#">Ring cpl.</a>	1
7.0	865128	Buchse   <a href="#">Bushing</a>	1
8.0	865548	Bolzen 50-355 OK   <a href="#">Pin</a>	1
9.0	865127	Ring   <a href="#">Ring</a>	3
10.0	798145	Deckel   <a href="#">Cover</a>	1
11.0	865129	Zentrierring   <a href="#">Center Ring</a>	1
12.0	35576	Spannstift schwer 16 x 100   <a href="#">Spring Pin Heavy</a>	1
13.0	755938	Verschraubung   <a href="#">Screwing</a>	16
14.0	700801	Tellerfeder   <a href="#">Spring</a>	14

# Kelly BK420/470/4/XX-S

## Kelly Bar

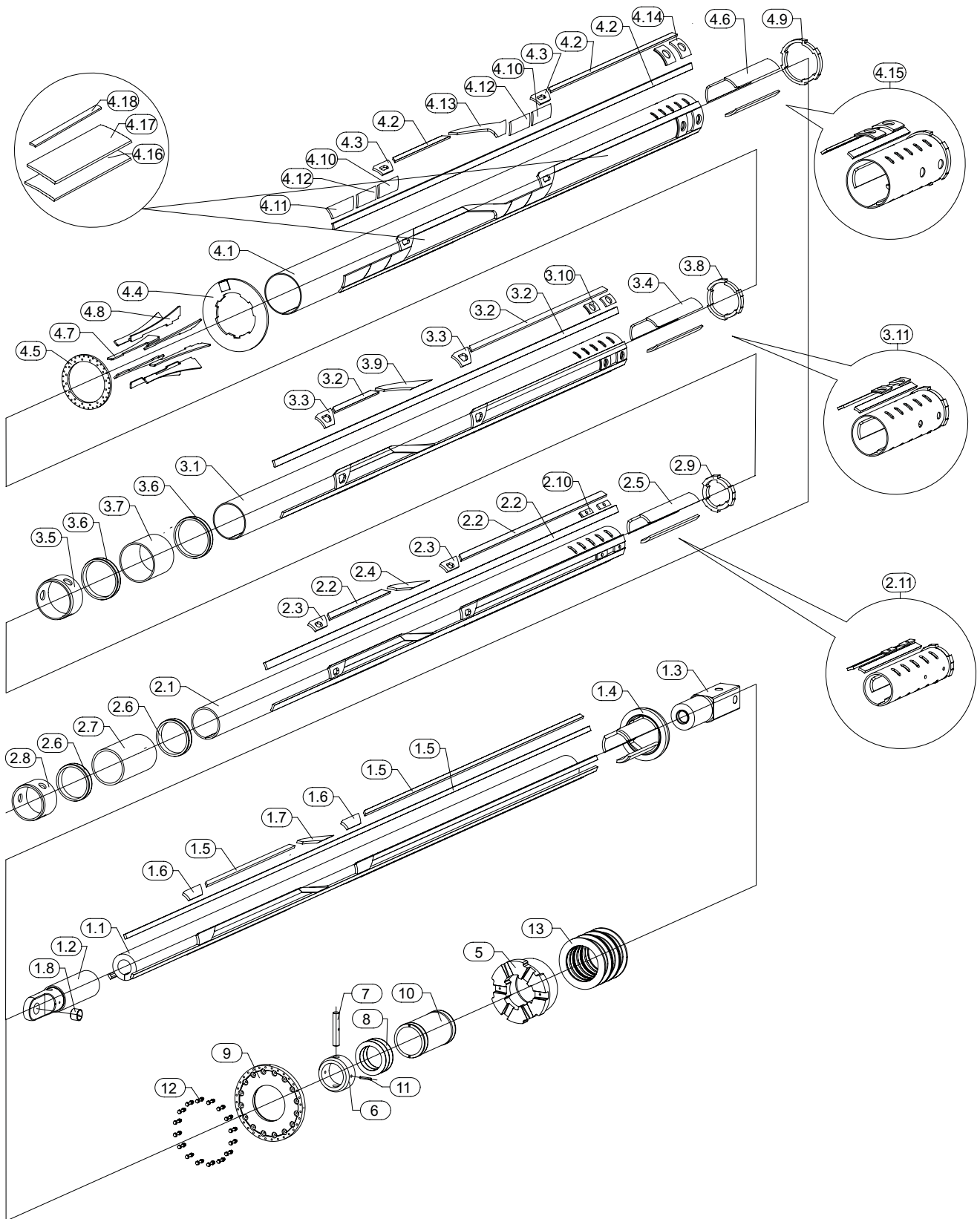

# Kelly BK420/470/4/XX-S

## Kelly Bar

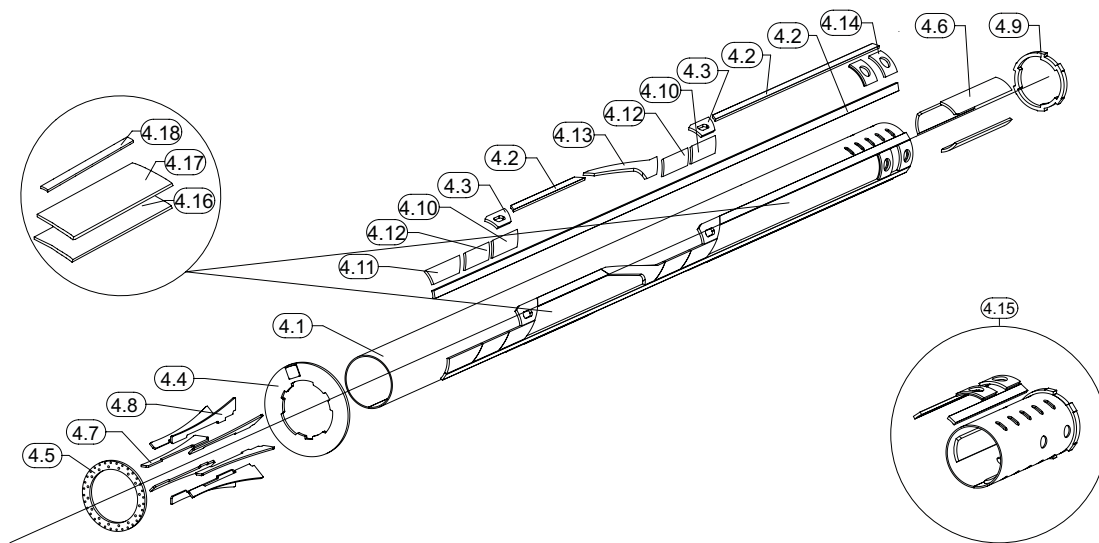

### Außenkelly kpl. | Outer Kelly cpl.

Darstellung Illustration	Bauer-Best.Nr. Bauer Item No.	Bezeichnung Description	Menge (Stck.) Quantity (pcs.)
4.1	1037990	Rund-Hohlprofil geschweißt 470-11   Round Hollow Sec. Welded	1*
4.2	1007871	Profilstahl 70 x 22   Section Steel	1*
4.3	100159	Anschlag   Stop	1*
4.4	1038620	Ring   Ring	1
4.5	779040	Ring   Ring	1
4.6	779070	Mitnehmerschale   Driving Shell	3
4.7	1038651	Blech   Sheet	5
4.8	1038652	Blech   Sheet	3
4.9	779041	Kellyanfänger   Kelly End	1
4.10	1038713	Stützschale   Shell	1*
4.11	1038714	Stützschale   Shell	3
4.12	1044749	Stützschale   Shell	1*
4.13	1038712	Schrägsegment-AK   Shell	1*
4.14	1038619	Endschale   End Husk	6
4.15	1071710	Kellyanfänger kpl. 470, L: 1500   Kelly End cpl.	1
4.16	959734	Schalldämmplatte 470   Sound Absorber	1*
4.17	959733	Blechplatte 470   Sheet	1*
4.18	47052	Bandstahl B: 20, S: 3   Steel Strip W: 20, T: 3	1*

# Kelly BK420/470/4/XX-S

## Kelly Bar

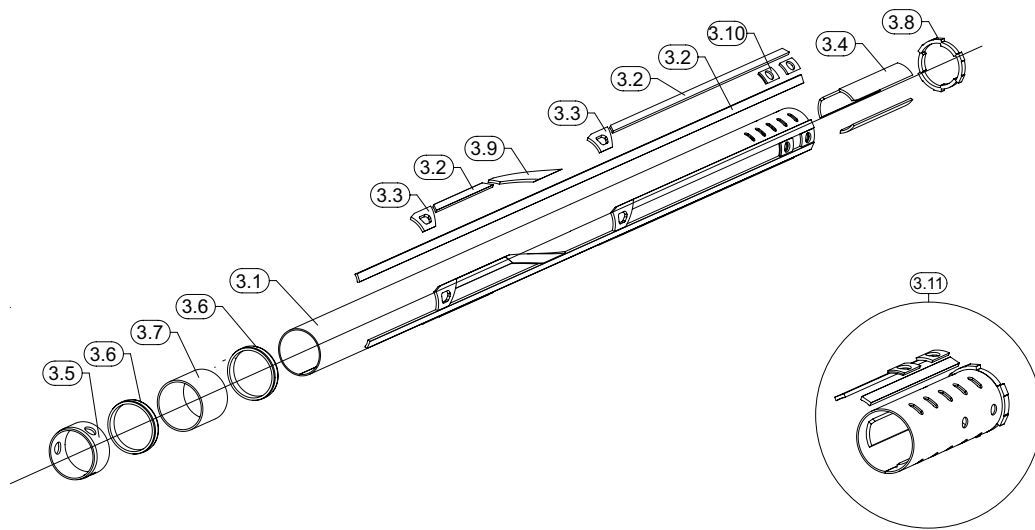

Zwischenkelly kpl.   Intermediate Kelly cpl.			
Darstellung Illustration	Bauer-Best.Nr. Bauer Item No.	Bezeichnung Description	Menge (Stck.) Quantity (pcs.)
3.1	1037570	Rund-Hohlprofil geschweißt 394-11   Round Hollow Sec. Selded	1*
3.2	1007871	Profilstahl 70 x 22   Section Steel	1*
3.3	101200	Anschlag Druckseite   Stop Pressure Side	1*
3.4	101198	Mitnehmerschale   Driving Shell	3
3.5	101223	Zentrierring   Center Ring	1
3.6	455591	Verschleißring   Wear Ring	2
3.7	455783	Zwischenrohr Ø 428, L: 400   Intermediate Tube	1
3.8	101226	Kellyanfänger   Kelly End	1
3.9	1038456	Schrägsegment-ZK   Shell	1*
3.10	1038337	Endschale   End Husk	6
3.11	1072401	Kellyanfänger kpl. 394, L: 1500   Kelly End cpl.	1

# Kelly BK420/470/4/XX-S

## Kelly Bar

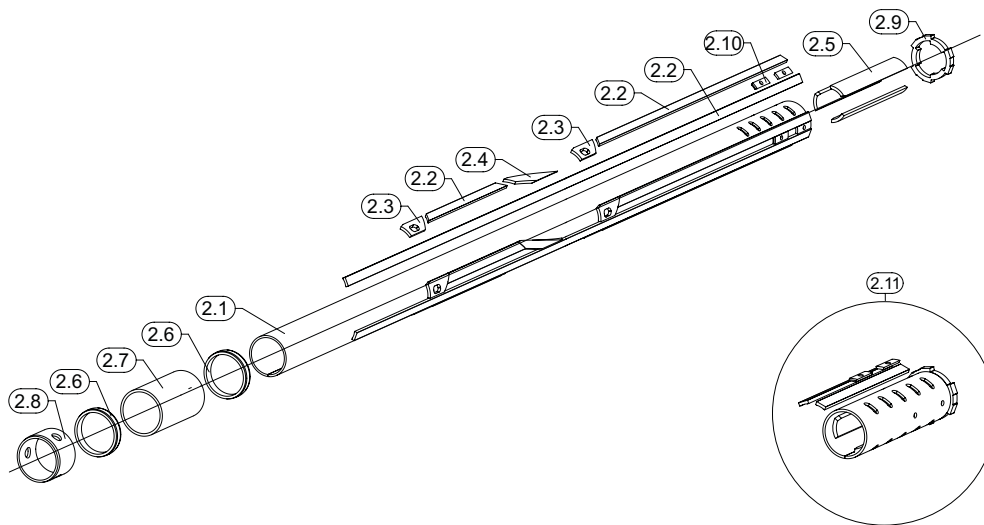

Mittelkelly kpl.   Mid Kelly cpl.			
Darstellung Illustration	Bauer-Best.Nr. Bauer Item No.	Bezeichnung Description	Menge (Stck.) Quantity (pcs.)
2.1	1037986	Rund-Hohlprofil geschweißt 318-16   Round Hollow Sec. Welded	1*
2.2	1007871	Profilstahl 70 x 22   Section Steel	1*
2.3	101199	Anschlag Druckseite   Stop Pressure Side	1*
2.4	1039073	Schrägsegment-MK   Shell	1*
2.5	101230	Mitnehmerschale   Driving Shell	3
2.6	455589	Verschleißring   Wear Ring	2
2.7	455590	Zentrierring   Center Ring	1
2.8	101228	Zentrierring   Center Ring	1
2.9	101215	Kellyanfänger   Kelly End	1
2.10	1039013	Endschale   End Husk	6
2.11	1072402	Kellyanfänger kpl. 318, L: 1500   Kelly End cpl.	1

# Kelly BK420/470/4/XX-S

## Kelly Bar

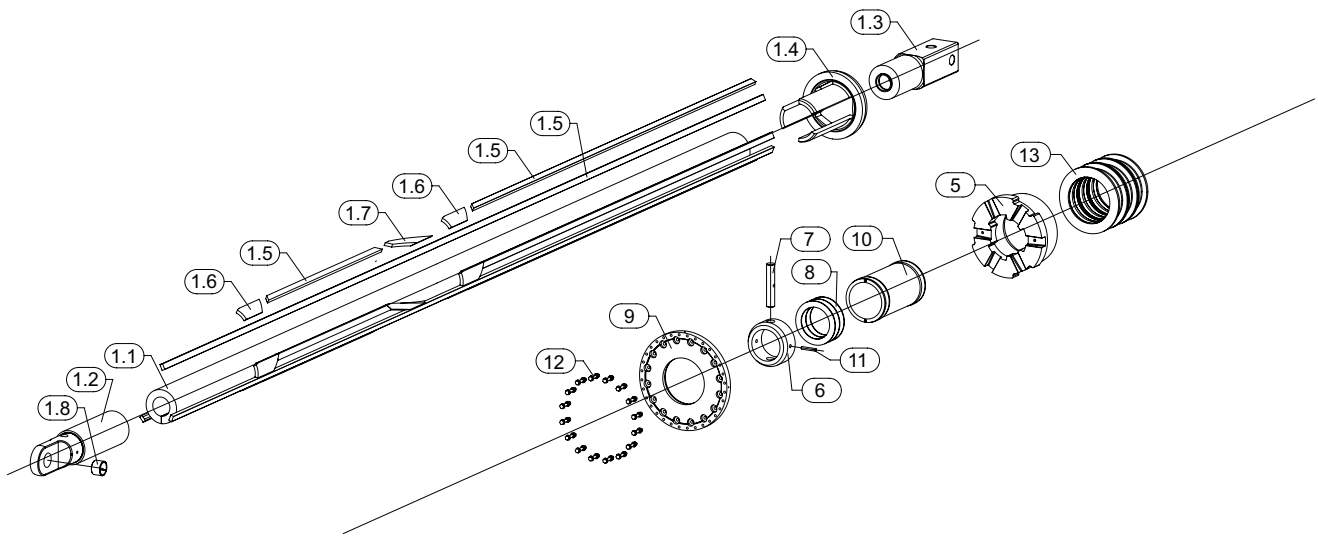

Innenkelly kpl.   Inner Kelly cpl.			
Darstellung Illustration	Bauer-Best.Nr. Bauer Item No.	Bezeichnung Description	Menge (Stck.) Quantity (pcs.)
1.1	799601	Stahlrohr nahtlos 229-50   <a href="#">Tube Seamless</a>	1*
1.2	798174	Anfangsstange   <a href="#">Initial Rod</a>	1
1.3	798167	Vierkant 200   <a href="#">Square</a>	1
1.4	100181	Führungsring   <a href="#">Guiding Ring</a>	1
1.5	1018282	Profilstahl 40 x 22   <a href="#">Section Steel</a>	1*
1.6	100208	Anschlag   <a href="#">Stop</a>	1*
1.7	1039133	Schrägsegment-IK   <a href="#">Shell</a>	1*
1.8	859903	Einspannbuchse   <a href="#">Tension Bushing</a>	1
5.0	1036662	Anschlagring   <a href="#">End Stop Ring</a>	1
6.0	72739	Hülse   <a href="#">Sleeve</a>	1
7.0	72740	Bolzen 50-264 OK   <a href="#">Pin</a>	1
8.0	72741	Ring   <a href="#">Ring</a>	3
9.0	779026	Deckel   <a href="#">Cover</a>	1
10.0	100183	Zentrierring   <a href="#">Center Ring</a>	1
11.0	35576	Spannstift schwer 16 x 100   <a href="#">Spring Pin Heavy</a>	1
12.0	755938	Verschraubung   <a href="#">Screwing</a>	16
13.0	793264	Dämpfer kpl.   <a href="#">Damper cpl.</a>	1

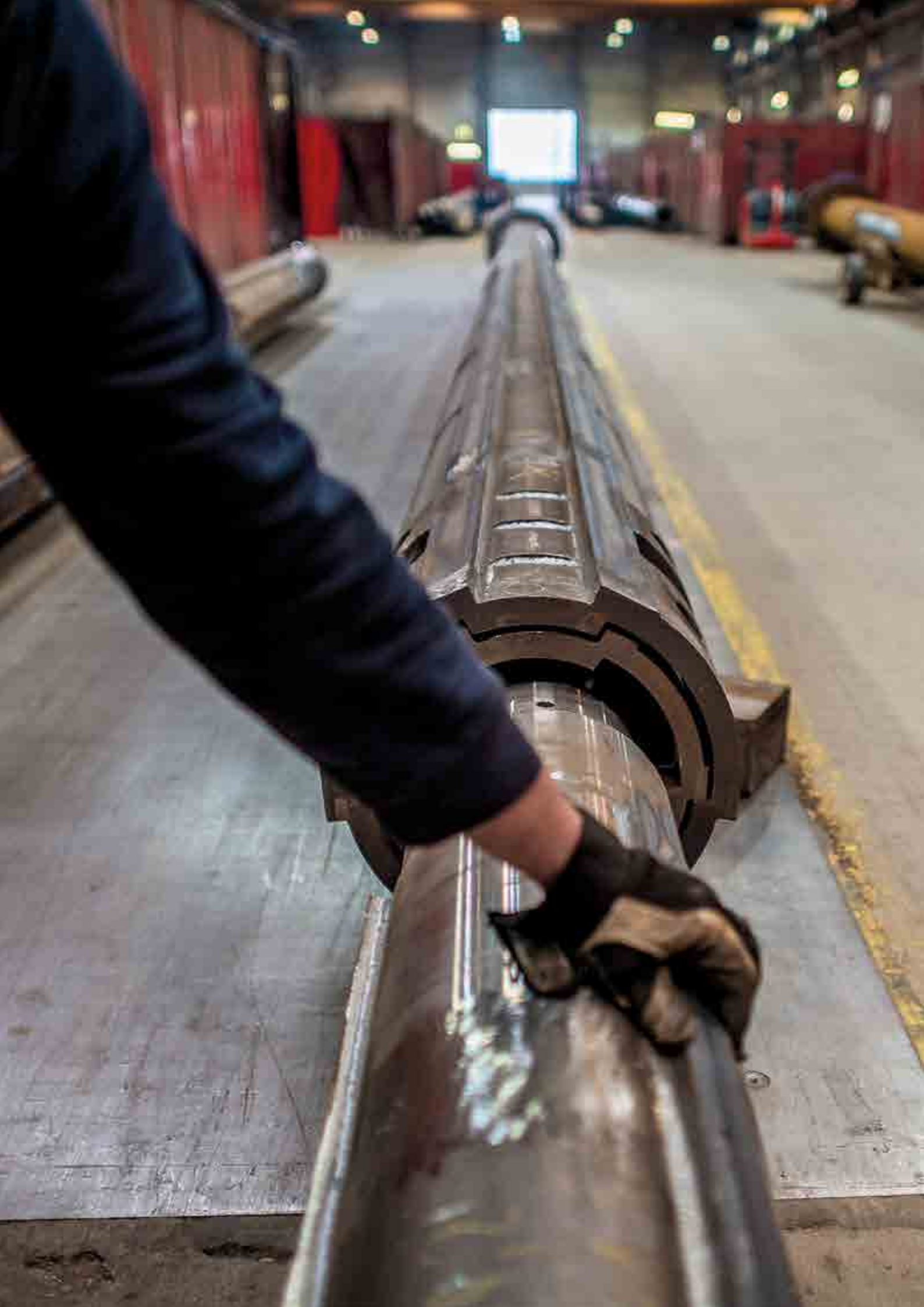

# Kellystangen

## Kelly Bars

### Kellyverlängerung | Kelly Extension



Form A



Form B

Bauer-Best.Nr. Bauer Item No.	Bezeichnung Description	Länge (mm) Length (mm)	Breite (mm) Width (mm)	Laschenform Connection Link Form
388374	Kelly Verlängerung Kelly Extension	1000	-	-
388365		2000	750	A
380382		3000	750	A
601226		3500	750	A
127230		4000	750	A
381693		5000	750	A
100039		6000	750	A
829414		8000	750	A
814009		12000	750	A
814010		15000	750	A
388366		10000	750	A
389396		2000	620	B
918863		3000	620	B
389395		5000	620	B
721352		7000	620	B
389397		10000	620	B



# Kellystangen

## Kelly Bars

### Kelly Box Adapter | Kelly Box Adapter

Darstellung Illustration	Bauer-Best.Nr. Bauer Item No.	Bezeichnung Description
	391770	Übergang Box 200/150 Crossing Box
	917625	Adapter Vierkant 130/200 kpl. Adapter Square cpl.
inklusive   includes:		
	917624	(1x) Bolzen 40-190 OK Pin
	234332	(2x) O-Ring 33 x 3 O-Ring
	119405	Adapter Vierkant 150/200 kpl. Adapter Square
inklusive   includes:		
	119403	(2x) Bolzen 42-191 OK Pin
	362860	(4x) O-Ring 35 x 3 O-Ring
	1202981	Ziehplatte für Vorschub Plus ab Ø 750 mm
	1202960	Pull Plate for Crowd Plus from Ø 750 mm



#3379

# Schlitzwand Diaphragm Walls



## Verschleißteile Schlitzwand Wear Parts Diaphragm Wall

· Rundschaftmeißel Round Shank Chisel	132 - 133
· Standard Fräszähne Standard Cutter Teeth	134 - 135
· CSM CSM	136
· Hybridfräsräder Hybrid Cutting Wheels	137
· Klappzähne Flap Teeth	138 - 141
· Tung Studs Tung Studs	142 - 143
· Greifer Grabs	144
· Wechselwerkzeuge Exchanging Tools	siehe Seite 29 - 36 / Register Drehbohrwerkzeuge see Page 29 - 36 / Index Drilling Tools

## Ersatzteile Schlitzwand Spare Parts Diaphragm Wall

· Bündelvorrichtung HTS-Schlauchband Bundle Device HTS Hose Pack	145
· Seilflaschenhalterung Pulley Mounting	146
· Schwenkantrieb an Seilflaschenhalterung Swivel Drive on Pulley Mounting	148 - 149
· Druckausgleich Förderpumpe Pressure Compensation Feed Pump	150
· Druckausgleich Pressure Compensation	151
· Druckausgleich kpl. P15.1, P15.2 Pressure Compensaton cpl. P15.1, P15.2	152
· Förderleitung Fräse Conveyor Line Cutter	153
· Förderpumpen Feed Pumps	154 - 163
· Saugkasten Suction Box	164 - 165
· Räumerersatz und Getriebe Schild-Verschleißteile Reamer Substitute and Wear Parts for Gear Shield	166
· Sensorik Fräsgetriebe Sensoric Gear Box	167
· Dichtungen Fräse Cutter Sealings	168
· Suspensionsverteiler BCM 5 Divider BCM 5	170 - 171
· Suspensionsverteiler BCM 10 Divider BCM 10	172 - 173

# Verschleißteile Schlitzwand

## Wear Parts Diaphragm Wall

### Rundschaftmeißel | Round Shank Chisel

<b>Kurzbezeichnung</b> Short Description	<b>RSM</b>	<b>D</b>		<b>17 x 30</b>	<b>HF</b>	
<b>Langbezeichnung</b> Long Description	<b>RSM</b>	<b>38 - 50</b>	<b>HF</b>	<b>17 x 30</b>		<b>131</b> <b>CL</b>
		Ø Schaft Ø Shaft	Ø Bund Ø Body	Ø Hartmetall Ø Tungsten	Länge Hartmetall Length Tungsten	Gesamtlänge Zahn Total Length Tooth

#### Optionale Spezifikation | Optional Specification





- HF** mit Hartauftragring | with Hardfacing Ring
- L** lange Version | Long Version
- S** kurze Version | Short Version
- TF** ohne Hartmetall | Tungsten-Free
- P** spezielle Form | Specific Form

#### Befestigungsart | Fixing Method

- CL** Spannhülse lang | Clamping Sleeve Long
- CS** Spannhülse kurz | Clamping Sleeve Short
- SR** Sicherungsring | Snap Ring

#### Kürzel für Kombination Schaft und Bund | Short Term for Combination Shaft and Body



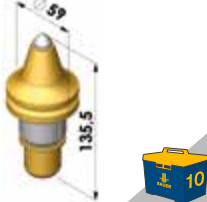
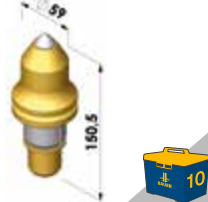



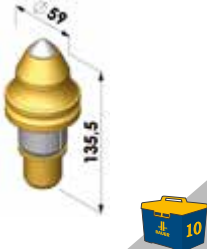

A	B	C	D	E	F	G	I	J
47-65	38-60	38-59	38-50	38-38	30-45	25-38	25-33	22-38
K	L	M	N	R	S	T		
19,4-38	19,4-27	18,7-27	13,9-20	12,9-20	11,3-20	11,3-17,5		

Darstellung Illustration	Bauer-Best.Nr. Bauer Item No.	Bezeichnung Description	Darstellung Illustration	Bauer-Best.Nr. Bauer Item No.	Bezeichnung Description
	992661	RSM-C 15x24 RSM 38-59-15x24-135,5-CL		1169857	RSM-C 17x26-P RSM 38-59-17x26-135,5-CL
	849545	RSM-C 19x23 RSM 38-59-19x23-135,5-CL		406955	RSM-C 19x28 RSM 38-59-19x28-135,5-CL
	1169853	RSM-C 19x28-P RSM 38-59-19x28-135,5-CL		728182	RSM-C 19x29-L* RSM 38-59-19x29-150,5-CL

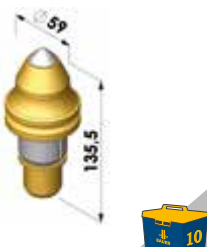
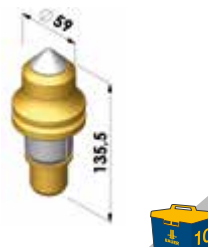
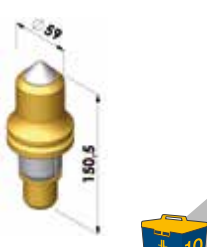

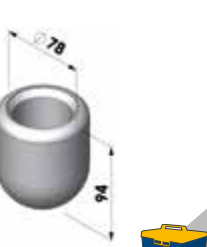
# Verschleißteile Schlitzwand

## Wear Parts Diaphragm Wall

Darstellung Illustration	Bauer-Best.Nr. Bauer Item No.	Bezeichnung Description	Darstellung Illustration	Bauer-Best.Nr. Bauer Item No.	Bezeichnung Description
	849546	RSM-C 22x27 RSM 38-59-22x27-135,5-CL		1188354	RSM-C 22x32-P RSM 38-59-22x32-135,5-CL
	367490	RSM-C 22x35 RSM 38-59-22x35-135,5-CL		134023	RSM-C 30x30 RSM 38-59-30x30-135,5-CL
	135007	RSM-C 30x30-L* RSM 38-59-30x30-150,5-CL		1323982	Rundschaftmeißelbuchse 50/38 Bush Round Shank Chisel
	363728	RSMH 50-TF ohne Hartmetall für Einbau RSMBU Tungsten-Free f. Bush Installation RSMBU		963554	VB-TS-C1 Verschleißblock Wear Block
	253707	Sechskantschraube mit Schaft M 20 x 130 Hexagon Head Screw		60558	Schraubstopfen Screw Plug
				429943	Reparaturvorrichtung Repair Device

\* Dieser Rundschaftmeißel darf aufgrund seiner Länge nur seitlich an den Fräsrädern eingesetzt werden. Eine falsche Anordnung dieser Zähne führt zu Beschädigungen der Fräse. Falls Sie weitere Informationen benötigen, kontaktieren Sie uns bitte unter [BMA-Parts-and-Service@bauer.de](mailto:BMA-Parts-and-Service@bauer.de)

This Round Shank Chisel is due to its length only to be used laterally on the cutting wheels. An incorrect arrangement could lead to damages. If you need any further information please contact us under [BMA-Parts-and-Service@bauer.de](mailto:BMA-Parts-and-Service@bauer.de)

# Verschleißteile Schlitzwand

## Wear Parts Diaphragm Wall

### Standard Fräszähne | Standard Cutter Teeth



Darstellung Illustration	Bauer-Best.Nr. Bauer Item No.	Darstellung Illustration	Bauer-Best.Nr. Bauer Item No.
	Bezeichnung Description		Bezeichnung Description
	94670		18071
	BFZ SB 38-ZM		BFZ SB 38-JM
	94847		94667
	BFZ SB 42-ZR		BFZ SB 42-JR
	94848		94668
	BFZ SB 42-ZL		BFZ SB 42-JL
	459487		372437
	BFZ SB 38-JMK-LC		BFZ SB 38-JMK



# Verschleißteile Schlitzwand

## Wear Parts Diaphragm Wall







Darstellung Illustration	Bauer-Best.Nr. Bauer Item No.
	Bezeichnung Description
	459484
	BFZ SB 42-JR-LC
	459490
	BFZ SB 42-JL-LC
	419204
	BFZ SB 25-M Plus
	1285913
	BFZ SB 73-PL
	1285915
	BFZ SB 50-PL
	441010
	Zahnhaltereinsatz Insert Teeth Holder
	15844
	Zahnhalter Teeth Holder

Darstellung Illustration	Bauer-Best.Nr. Bauer Item No.	
	Bezeichnung Description	
	416419	
	BFZ SB 38 HR	
	1285917	
	BFZ SB 50-PR	
	1285914	
	BFZ SB 73-PR	
	390445	
	BFZ CWP Ø 20	
	441007	
	Zahnhalter für Einsatz 441010 Teeth Holder for Insert 441010	
	87904	
	Spannstift Spring Pin	

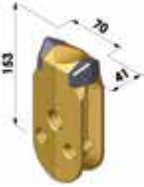
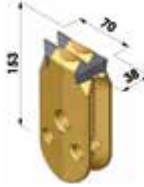
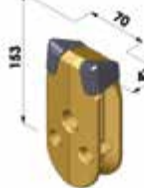
# Verschleißteile Schlitzwand

## Wear Parts Diaphragm Wall

CSM | CSM

Darstellung Illustration	Bauer-Best.Nr. Bauer Item No.  Bezeichnung Description	Darstellung Illustration	Bauer-Best.Nr. Bauer Item No.  Bezeichnung Description
	644206  BFZ DC SB 38-JMK		619274  BFZ DC SB 38-HR
	913234  BFZ DC SB 42-JLR		925428  Zahnhalter BCM 5 Teeth Holder
	838218  Zahnhalter BCM 10 Teeth Holder		711587  Abstreifer Scraper
	412675  Kunststoffstift Kunststoff Synthetic Pin		886706  Verschleißblech VB 50 x 35 Wear Plate
	87904  Spannstift Spring Pin		



# Verschleißteile Schlitzwand

## Wear Parts Diaphragm Wall

### Hybridfräsräder | Hybrid Cutting Wheels





Darstellung Illustration	Bauer-Best.Nr. Bauer Item No.	Bezeichnung Description
	943687	Flachzahn FZ 72-C Flat Teeth
	943684	Flachzahnhalter FZH 72-C Holder Flat Teeth
	943683	Flachzahnbuchse FZB 72-C Bush Flat Teeth
	60558	Schraubstopfen Screw Plug
	711587	Abstreifer Scraper
	362435	Verschleißleiste VL 150 x 50 x 10 Wear Strip
	370172	Verschleißleiste VL 100 x 50 x 10 Wear Strip

# Verschleißteile Schlitzwand

## Wear Parts Diaphragm Wall



### Klappzähne | Flap Teeth

<b>BC 30 - BC 32 - BC 35 - BC 40 - BC 48</b> für Schlitzlänge 2800 for Trench Length 2800					
		Links Left	Rechts Right	Links Left	Rechts Right
Bezeichnung Description		Bauer-Best.Nr. Bauer Item No.			
Klappzahn kpl. Flap Teeth cpl.		1100838	1100898	837124	837123
Bestehend aus   Consists of					
Bauer-Best.Nr. Bauer Item No.	Bezeichnung Description	Anzahl Quantity			
921521	Abweisklotz verbesserte Form Rejection Block Improved Shape	1x	1x	1x	1x
243524	Einspannbuchse Tension Bushing	2x	2x	2x	2x
258201	Zyl. Schraube mit Innensechskant M 16 x 20 Hexagon Screw	2x	2x	2x	2x
1323982	Rundschaftmeißelbuchse 50/38 Bush Round Shank Chisel 			3x	3x
779789	Anlaufscheibe, OD: 85 mm, ID: 55 mm Thrust Washer	2x	2x	2x	2x
Bezeichnung Description		Bauer-Best.Nr. Bauer Item No.			
Klappzahn s+b Flap Teeth		1100837	1100897	837108	837106

# Verschleißteile Schlitzwand



## Wear Parts Diaphragm Wall



<b>BC 50</b> für Schlitzlänge 2800 for Trench Length 2800		 23°		 16°			
		Links Left	Rechts Right	Links Left	Rechts Right	Links Left	Rechts Right
Bezeichnung Description		Bauer-Best.Nr. Bauer Item No.					
Klappzahn kpl. Flap Teeth cpl.		1080208	1080207	1080210	1080209	962330	962288
Bestehend aus   Consists of							
Bauer-Best.Nr. Bauer Item No.	Bezeichnung Description	Anzahl Quantity					
921521	Abweisklotz verbesserte Form Rejection Block Improved Shape	1x	1x	1x	1x	1x	1x
779789	Anlaufscheibe OD: 85 mm, ID: 55 mm Thrust Washer	2x	2x	2x	2x	2x	2x
243524	Einspannbuchse Tension Bushing	2x	2x	2x	2x	2x	2x
258201	Zyl. Schraube mit Innensechskant M 16 x 20 Hexagon Screw	2x	2x	2x	2x	2x	2x
1323982	Rundschaftmeißelbuchse 50/38 Bush Round Shank Chisel					3x	3x
Bezeichnung Description		Bauer-Best.Nr. Bauer Item No.					
Klappzahn s+b Flap Teeth		1080201	1080206	1080205	1080204	962328	962287
Zusätzliche Teile BC 30, BC 32, BC 35, BC 40, BC 48, BC 50   Additional Parts							
Bauer-Best.Nr. Bauer Item No.	Bezeichnung Description	Anzahl Quantity					
116715	Bolzen 45-364 AB Pin	2x					
116716	Bolzensicherung Pin Lock	2x					
54252	Spannstift Pin	2x					
60466	Loctide 243 Schraubensicherung, mittelfest, 50 ml Threadlocker, Medium Strength	1x					

# Verschleißteile Schlitzwand



## Wear Parts Diaphragm Wall

<b>BCM</b>		 <b>BCM 5</b>	 <b>BCM 10</b>
Bezeichnung Description		Bauer-Best.Nr. Bauer Item No.	
Klappzahn kpl. Flap Teeth cpl.		925551	1326044
Bestehend aus   Consists of			
Bauer-Best.Nr. Bauer Item No.	Bezeichnung Description	Anzahl Quantity	
926105	Abweisklotz Spezialbeschichtung Rejection Block Special Coating	1x	
926108	Abweisklotz verbesserte Form Spezialbeschichtung Rejection Block Improved Shape Special Coating		1x
258201	Zyl. Schraube   Hexagon Screw	2x	2x
16327	Anlaufscheibe   Thrust Washer	2x	
243523	Anlaufscheibe   Thrust Washer		2x
16326	Einspannbuchse   Tension Bushing	2x	
243524	Einspannbuchse   Tension Bushing		2x
838352	Klappzahn s+b   Flap Teeth	1x	
1326043	Klappzahn s+b   Flap Teeth		1x
886706	Verschleißblech 50x35   Wear Plate	2x	2x
<b>Zusätzliche Teile   Additional Parts</b>			
Bauer-Best.Nr. Bauer Item No.	Bezeichnung Description	Anzahl Quantity	
102303	Bolzen   Pin	1x	
116715	Bolzen   Pin		1x
926694	Bolzensicherung   Pin Lock	2x	
846965	Bolzensicherung   Pin Lock		1x
846966	Bolzensicherung   Pin Lock		1x

# Verschleißteile Schlitzwand

## Wear Parts Diaphragm Wall

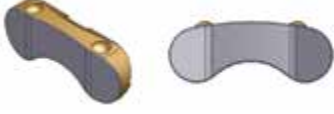

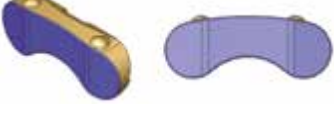









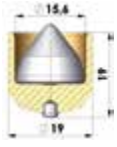

Übersicht Abweisklötze   Summary Rejection Blocks				
Darstellung Illustration	Bauer-Best.Nr. Bauer Item No.	Bezeichnung Description	Verwendung Usage	
	161509	Abweisklotz Rejection Block	Fräsen   Cutter BCM 5 BCM 10	
	921521	Abweisklotz verbesserte Form Rejection Block Improved Shape	Fräsen   Cutter BCM 10	
	926105	Abweisklotz Spezialbeschichtung Rejection Block Special Coating	Fräsen   Cutter BCM 5 BCM 10	
	926108	Abweisklotz verbesserte Form Spezialbeschichtung Rejection Block Improved Shape Special Coating	Fräsen   Cutter BCM 10	



# Verschleißteile Schlitzwand

## Wear Parts Diaphragm Wall







### Tung Studs | Tung Studs

Darstellung Illustration	Bauer-Best.Nr. Bauer Item No.		846593		861455		970703
	Bezeichnung Description		TS-C 1		TS-C 4		TS-C 5
Darstellung Illustration	Bauer-Best.Nr.   Bauer Item No.		Bezeichnung   Description				
	-	-	926174	Bolzenhalter für   for TS-C 5 Stud Holder			
	-	-	926160	Bolzenhalter für   for TS-C 4 Stud Holder			
	926175	-	Bolzenhalter für   for TS-C 1 Stud Holder				
	-	-	926178	Keramikringhalter für   for TS-F 1, TS-C 5 Ceramic Ring Holder			
	926176	-	Keramikringhalter für   for TS-F 2, TS-C 1 Ceramic Ring Holder				
	-	-	926177	Keramikringhalter für   for TS-C 4, TS-F 3 Ceramic Ring Holder			
	-	-	926179	Fußplatte für   for TS-C 5, TS-F 1 Foot Plate			
	926180	-	Fußplatte für   for TS-C 1, TS-C 4, TS-F 2, TS-F 3 Foot Plate				
	1692254		Studwelder Universal für alle Bauer Tung Studs   for all Bauer Tung Studs				

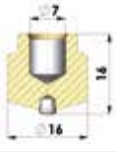
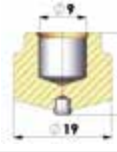
# Verschleißteile Schlitzwand

## Wear Parts Diaphragm Wall



Darstellung Illustration	Bauer-Best.Nr. Bauer Item No.		724345		853162		742152
	Bezeichnung Description		TS-F 1		TS-F 2		TS-F 3
Darstellung Illustration	Bauer-Best.Nr.   Bauer Item No.						
	Bezeichnung   Description						
	926157						
	Bolzenhalter für   for TS-F 1 Stud Holder						
	-			926158			
				Bolzenhalter für   for TS-F 2 Stud Holder			
	-					926159	
						Bolzenhalter für   for TS-F 3 Stud Holder	
	926178						
	Keramikringhalter für   for TS-F 1, TS-C 5 Ceramic Ring Holder						
	-			926176			
				Keramikringhalter für   for TS-F 2, TS-C 1 Ceramic Ring Holder			
	-					926177	
						Keramikringhalter für   for TS-F 3, TS-C 4 Ceramic Ring Holder	
	926179						
	Fußplatte für   for TS-F 1, TS-C 5 Foot Plate						
	-			926180			
				Fußplatte für   for TS-F 2, TS-F 3, TS-C 1, TS-C 4 Foot Plate			
	853164						
	Studwelder Universal für alle Bauer Tung Studs   for all Bauer Tung Studs						

# Verschleißteile Schlitzwand

## Wear Parts Diaphragm Wall

Greifer | Grabs

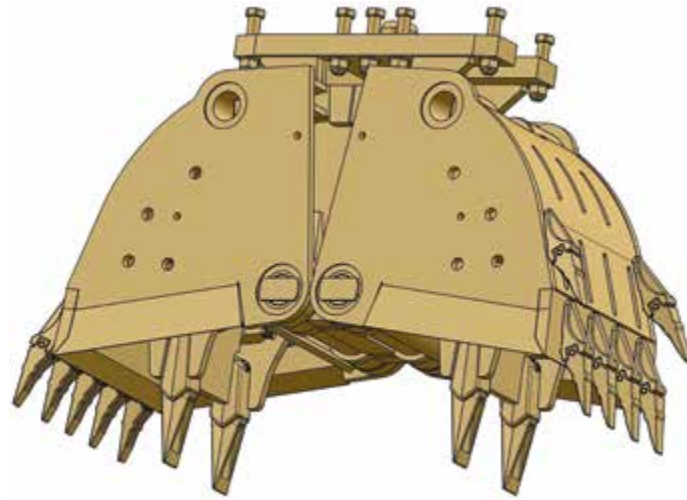

Schlitzwandgreifer DHG Typ: A / B / C / D / E   Diaphragm Wall Grab DHG Type: A / B / C / D / E					
Darstellung Illustration	Bauer-Best.Nr. Bauer Item No.	Bezeichnung Description	Darstellung Illustration	Bauer-Best.Nr. Bauer Item No.	Bezeichnung Description
	239116	Spitze 25 RC 10 Tip		1065244	Stoßzahn Surge Tooth
	98216	Spitze 25 RC 12 Tip		1065062	Stoßzahn Surge Tooth
	934093	Spitze 25 RC 12 W Tip		1065245	Hülse Sleeve
	239115	Spitze 25 RC 12 VIP Tip		219260	Stift 25 RC - PN Pin
				39877	Bolzen f. Stoßzahn Pin for Surge Tooth
	98215	Greiferzahnhalter 25 RC Grab Tooth Holder		219261	Scheibe 25 RC - LKSR Disc
	1047300	Einspannbuchse Tension Bushing		1047534	Einspannbuchse Tension Bushing

# Ersatzteile Schlitzwand

## Spare Parts Diaphragm Wall



Bündelvorrichtung HTS-Schlauchband | Bundle Device HTS Hose Pack



Position Position	Bauer-Best.Nr. Bauer Item No.	Bezeichnung Description
A	1173699	Bündelvorrichtung kpl. Bundle Device cpl.  beinhaltet   included 506300 Zange Clamping Device
B	353191	Ladungssicherungsband CC 105 Load Securing Strap
C	353194	Verschlussklemmen Clamp





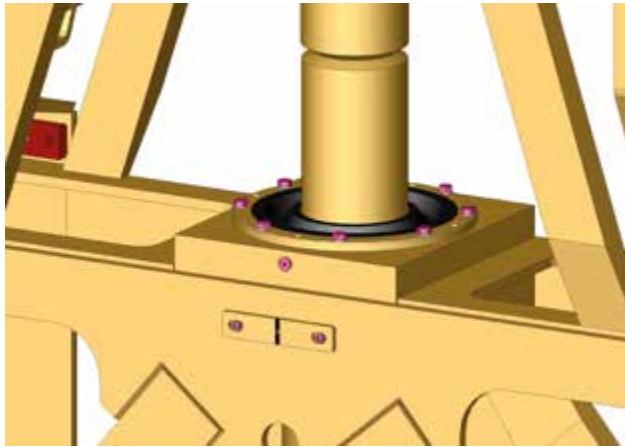

# Ersatzteile Schlitzwand

## Spare Parts Diaphragm Wall

### Seilflaschenhalterung | Pulley Mounting



passend für | fits to:  
BC 32, BC 35, BC 40, BC 48

Darstellung Illustration	Bauer-Best.Nr. Bauer Item No.	Bezeichnung Description
	120606	(1x) Wellendichtring kpl. Shaft Seal Ring cpl.
	21118	(1x) Fluidtechnik-O-Ring 200 x 5 Fluid Power System O-Ring
	210953	(1x) Fluidtechnik-O-Ring 360 x 6 Fluid Power System O-Ring
	269743	(1x) Turcon-Excluder 5 Turcon Excluder
	32546	(8x) Sechskantschraube Ge. bis Kopf M 16 x 45 Hexagon Head Screw
	375758	(8x) Sicherungsscheiben 16, selbsthemmend Disk/Washer, Self Locking



# Ersatzteile Schlitzwand

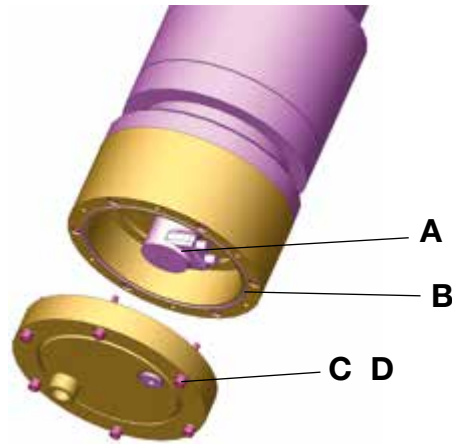

## Spare Parts Diaphragm Wall

### Schwenkantrieb an Seilflaschenhalterung | Swivel Drive on Pulley Mounting

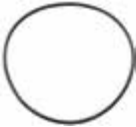

passend für | fits to:

BC 32, BC 35, BC 40



Position Position	Darstellung Illustration	Bauer-Best.Nr. Bauer Item No.	Bezeichnung Description
A		848886	(1x) Drehwinkelgeber Swing Angle Sensor
B		244773	(1x) Fluidtechnik-O-Ring 195 x 3 Fluid Power System O-Ring
C		32640	(6x) Zyl. Schraube mit I-6-kant M 8 x 50 Hexagon Socket Head Cap Screw
D		618948	(6x) Sicherungsscheibe 8 selbsthemmend Disk/Washer, Self Locking

# Ersatzteile Schlitzwand

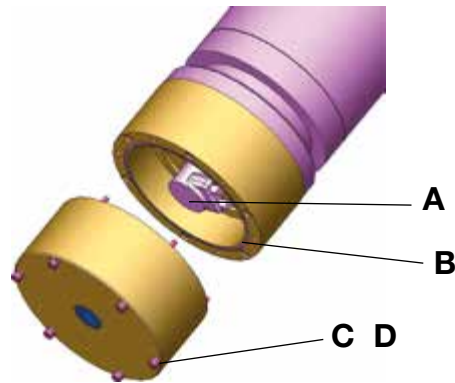
## Spare Parts Diaphragm Wall

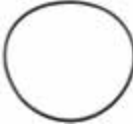

passend für | fits to:  
BC 48

Position Position	Darstellung Illustration	Bauer-Best.Nr. Bauer Item No.	Bezeichnung Description
A		848886	(1x) Drehwinkelgeber Swing Angle Sensor
B		244773	(1x) Fluidtechnik-O-Ring 195 x 3 Fluid Power System O-Ring
C		35385	(6x) Schraube M 8 x 120 Screw
D		618948	(6x) Sicherungsscheibe 8 selbsthemmend Disk/Washer, Self Locking

# Ersatzteile Schlitzwand





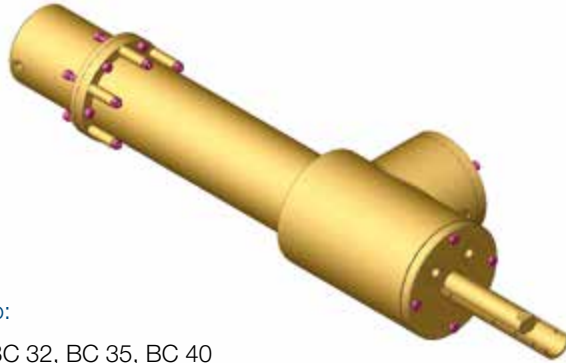

## Spare Parts Diaphragm Wall

### Druckausgleich Förderpumpe | Pressure Compensation Feed Pump

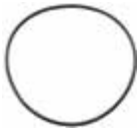

passend für | fits to:

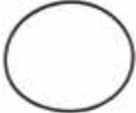
MBC 30, BC 30, BC 32, BC 35, BC 40

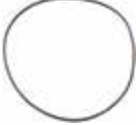
Darstellung Illustration	Bauer-Best.Nr. Bauer Item No.	Bezeichnung Description	Darstellung Illustration	Bauer-Best.Nr. Bauer Item No.	Bezeichnung Description
	95989	(1x) Rollmembran Diaphragm		21634	(1x) Fluidtechnik- O-Ring 150 x 4 Fluid Power System O-Ring
	80007	(1x) Abstreifer Deflector		40936	(1x) Turcon Stepseal K Turcon Stepseal K
	12782	(1x) Turcon Excluder 500 Turcon Excluder		40935	(1x) Stangen- führungsring Rod-Guiding Ring
	242931	(1x) Fluidtechnik- O-Ring 148 x 4 Fluid Power System O-Ring		19535	(1x) Näherungs- schalter Proximity Switch
	402024	(1x) Fluidtechnik- O-Ring 145 x 3 Fluid Power System O-Ring			

# Ersatzteile Schlitzwand

## Spare Parts Diaphragm Wall





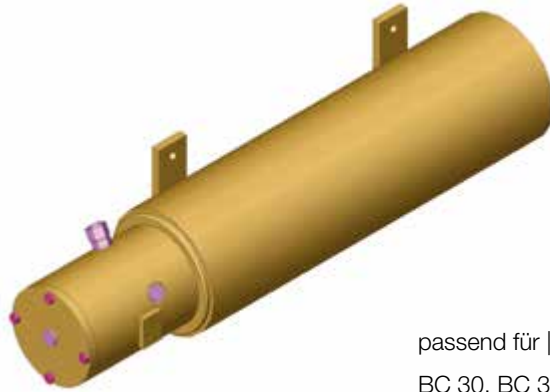

### Druckausgleich | Pressure Compensation



passend für | fits to:

BC 30, BC 32, BC 35, BC 40

Darstellung Illustration	Bauer-Best.Nr. Bauer Item No.	Bezeichnung Description
	48696	(1x) Perbunan- blase 20 l Perbunan Bladder
	86750	(1x) Perbunan- blase 10 l, nur für MBC 30 Perbunan Bladder only for MBC 30

Darstellung Illustration	Bauer-Best.Nr. Bauer Item No.	Bezeichnung Description
	49365	(1x) Fluidtechnik O-Ring 120 x 6 Fluid Power System O-Ring
	441454	(1x) Mutter Nut

# Ersatzteile Schlitzwand

## Spare Parts Diaphragm Wall

Druckausgleich kpl. P15.1, P15.2 | Pressure Compensation cpl. P15.1, P15.2

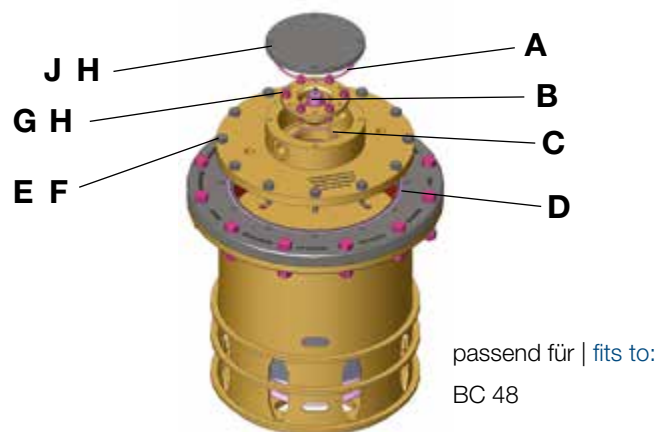





Position Position	Darstellung Illustration	Bauer-Best.Nr. Bauer Item No.	Bezeichnung Description	P 15.1	P 15.2
A		242931	Fluidtechnik-O-Ring 148 x 4 Fluid Power System O-Ring	1x	1x
B		19535	Näherungsschalter L: 61 mm, M 18 x 1 Proximity Switch	1x	
B		1114787	Magneto - Induktiver Wegsensor Magneto - Inductive Displacement Sensor		1x
C		530196	Fluidtechnik-O-Ring 88 x 3 Fluid Power System O-Ring	1x	1x
D		24056	Fluidtechnik-O-Ring 325 x 5 Fluid Power System O-Ring	1x	1x
E		209822	Sechskantschraube Gew. bis Kopf M 12 x 40 Hexagon Head Screw	12x	12x
F		375755	Sicherungsscheiben 12, selbsthemmend Disk/Washer, Self Locking	12x	12x
G		77745	Zyl. Schraube mit I-6-kant M 10 x 25, 10.9 Hexagon Socket Head Cap Screw	6x	6x
H		24574	Sicherungsscheibe 10 Retaining Washer	10x	10x
J		35226	Zyl. Schraube mit I-6-kant M 10 x 25, 8.8 Hexagon Socket Head Cap Screw	4x	4x

# Ersatzteile Schlitzwand

## Spare Parts Diaphragm Wall



### Förderleitung Fräse | Conveyor Line Cutter

Darstellung Illustration	Bauer-Best.Nr. Bauer Item No.	Bezeichnung Description
	BC 32, BC 35, BC 40	
	63592	(1x) Festpunkt s+b Fixing Point
	242091	(1x) Förderschlauch Ø 152, L: 2,4 m Feed Hose
	845535	(4x) Schelle Clamp
	63833	(7x) Fluidtechnik O-Ring 180 x 3 Fluid Power System O-Ring
	55450	(1x) Flachdichtung Flat Seal

# Ersatzteile Schlitzwand

## Spare Parts Diaphragm Wall

### Förderpumpen | Feed Pumps

#### Förderpumpe 6" | Feed Pump

Darstellung Illustration	Bauer-Best. Nr. Bauer Item No.	Bezeichnung Description
-	973391	Förderpumpe 6"   Feed Pump

Bestehend aus (1 - 4) | Consists of (1 - 4)

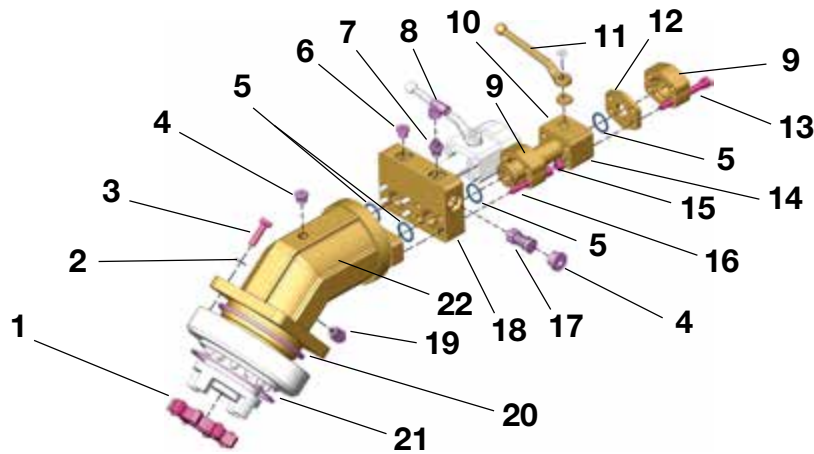

A

Darstellung Illustration	Bauer-Best.Nr. Bauer Item No.	Bezeichnung Description
1	50037	(1x) Zahnkranz Gear Ring
2	24577	(4x) Sicherungsscheibe 16 Safety Disc
3	202159	(4x) Sechskantschraube M 16 x 50 Hexagon Head Screw
4	63583	(1x) Verschlusschraube Locking Screw
5	57449	(4x) Flanschdichtung SAE 1 1/4", J 518   Flange Sealing
6	240607	(1x) Verschlusschraube 1/2" Locking Screw
7	231130	(1x) Gerade Verschraubung Straight Fitting
8	230861	(1x) Winkel-Stutzen Elbow Fitting
9	38109	(1x) SAE-Flanschhälfte 1 1/4, DN 32 SAE Flange Half
10	394186	(1x) Anschlagsscheibe Guide Washer

Darstellung Illustration	Bauer-Best.Nr. Bauer Item No.	Bezeichnung Description
11	633476	(1x) Griff gekröpft SW 14 Offset Handle
12	15315	(1x) SAE-Zwischenflansch Intermediate Flange
13	76303	(4x) Zyl. Schraube M 14 x 20 Hexagon Socket
14	224606	(4x) Kugelhahn SAE 1 1/4" Ball Valve
15	276557	(4x) Sechskantmutter M 14 Hexagon Nut
16	396961	(4x) Zyl. Schraube M 14 x 95 Hex. Socket Head Cap Screw
17	63582	(1x) Rückschlagventil Return Valve
18	19273	(1x) Zwischenblock Interim Block
19	231159	(1x) Gerade Verschraubung Straight Fitting
20	20984	(1x) Fluidtechnik-O-Ring 180 x 4 Fluid Power System O-Ring



# Ersatzteile Schlitzwand

## Spare Parts Diaphragm Wall

Darstellung Illustration	Bauer-Best.Nr. Bauer Item No.	Bezeichnung Description
21	20985	(1x) Fluidtechnik-O-Ring 190 x 5 Fluid Power System O-Ring
22	15840	(1x) Konstantmotor Displacement Motor

Darstellung Illustration	Bauer-Best.Nr. Bauer Item No.	Bezeichnung Description
-	1033005	(1x) Dichtsatz für Konstantmotor Seal Kit Displacement Motor

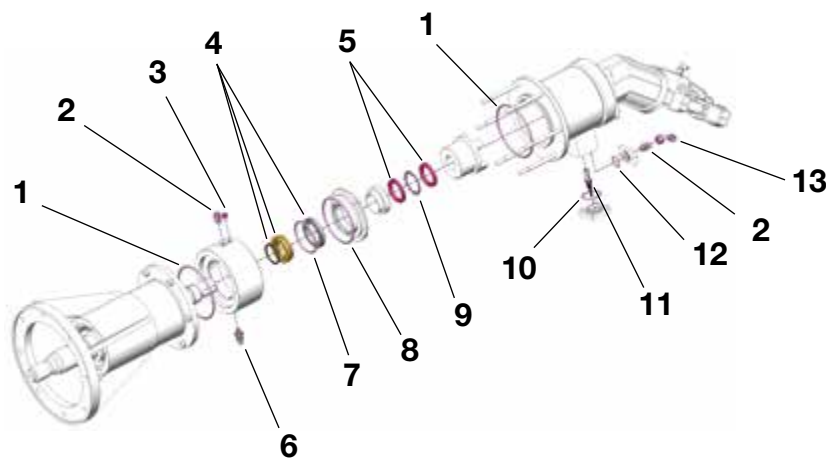

**B**

Darstellung Illustration	Bauer-Best.Nr. Bauer Item No.	Bezeichnung Description
1	21122	(2x) Fluidtechnik-O-Ring 210 x 5 Fluid Power System-O-Ring
2	231133	(2x) Gerade Verschraubung Straight Fitting
3	240622	(1x) Verschlusschraube Locking Screw
4	18937	(1x) Gleitringdichtung Slide Ring Sealing
5	12425	(2x) Nutmutter M 75 x 2 Groove Nut
6	25062	(1x) Minimessanschluss Minimeter Connection
7	86097	(1x) Fluidtechnik-O-Ring 122 x 4 Fluid Power System-O-Ring

Darstellung Illustration	Bauer-Best.Nr. Bauer Item No.	Bezeichnung Description
8	20984	(1x) Fluidtechnik-O-Ring 180 x 4 Fluid Power System-O-Ring
9	21817	(1x) Sicherungsblech Locking Plate
10	33741	(1x) Fluidtechnik-O-Ring 64 x 3 Fluid Power System-O-Ring
11	65415	(1x) Näherungsschalter, induktiv Proximity Switch, Inductive
12	36475	(1x) Fluidtechnik-O-Ring 34 x 3 Fluid Power System-O-Ring
13	23086	(1x) Zwischenstück Rohrbogen 90° Intermediate Piece Elbow Tube

# Ersatzteile Schlitzwand

## Spare Parts Diaphragm Wall

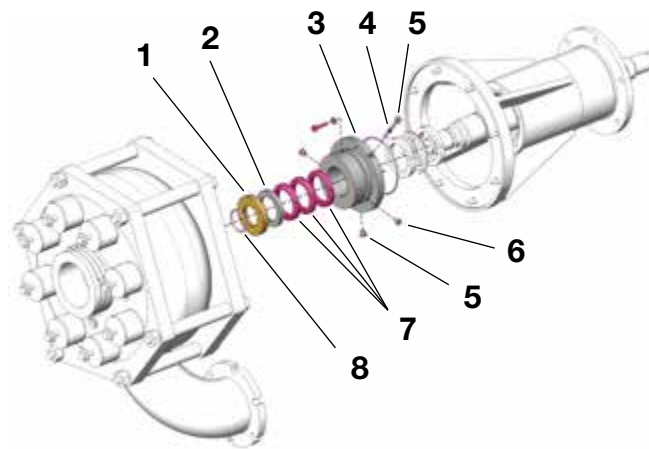

C

Darstellung Illustration	Bauer-Best.Nr. Bauer Item No.	Bezeichnung Description
1	43871	(1x) Wellenschutzhülse Protective Sleeve
2	19231	(1x) Zwischenring 80 Intermediate Ring
3	1332776	(1x) Gleitringdichtung kpl. Slide Ring Sealing cpl.
4	391577	(1x) Rückschlagventil kpl. Back-Pressure Valve cpl.
5	240614	(2x) Verschlusschraube 3/8" Locking Screw
6	203327	(1x) Verschlusschraube, Edelstahl Locking Screw, Stainless Steel
7	35265	(3x) Nutmutter M 90 x 2 Locknut
8	21241	(1x) Fluidtechnik-O-Ring 65 x 4 Fluid Power System O-Ring



# Ersatzteile Schlitzwand

## Spare Parts Diaphragm Wall

D

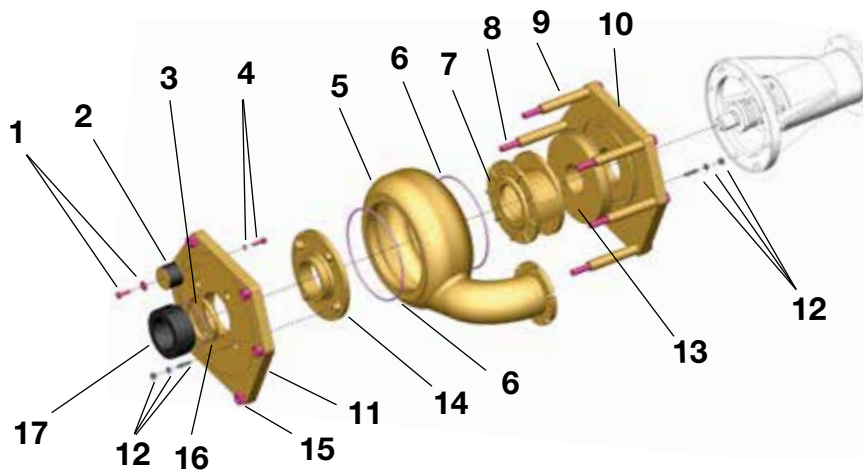

Darstellung Illustration	Bauer-Best.Nr. Bauer Item No.	Bezeichnung Description
1	46998	(8x) Schraube M 16 x 50 Screw
	24577	(8x) Sicherungsscheibe 16 mm Lock Washer
2	201775	(8x) Schwingmetallpuffer Vibrating Metal Buffer
3	21118	(1x) Fluidtechnik-O-Ring 200 x 5 Fluid Power System O-Ring
4	32374	(8x) Schraube M 16 x 45 Screw
	24577	(8x) Sicherungsscheibe 16 mm Lock Washer
5	19286	(1x) Pumpengehäuse Pump Casing
6	61606	(2x) Fluidtechnik-O-Ring 400 x 4 Fluid Power System O-Ring
7	43129	(1x) Zweikanallaufgrad Two Canal Running Wheel
8	19276	(6x) Sechskantschraube M 30 x 380   Hexagon Bolt
9	19277	(6x) Rohr Tube

Darstellung Illustration	Bauer-Best.Nr. Bauer Item No.	Bezeichnung Description
10	19278	(1x) Gehäusedeckel antriebseitig Cover Driving End
11	19287	(1x) Gehäusedeckel saugseitig Cover Driving Suction Side
12	352331	(8x) Stiftschraube Stud
	50028	(8x) Plastikscheibe Plastic Washer
	35180	(8x) Sechskantmutter Hexagon Nut
13	19279	(1x) Schleißplatte Antriebsseite Wear Plate Drive End
14	44235	(1x) Schleißplatte Saugseite Wear Plate Suction Side
15	202166	(6x) Sechskantmutter M 30 Hexagon Nut
	26701	(6x) Sicherungsscheibe 30 Disc
16	364373	(1x) Ring Ring
17	232664	(1x) Distanzring Spacer Ring

# Ersatzteile Schlitzwand

## Spare Parts Diaphragm Wall

### Förderpumpe 6" HD | Feed Pump

Darstellung Illustration	Bauer-Best. Nr. Bauer Item No.	Bezeichnung Description
-	1193303	Förderpumpe 6" HD   Feed Pump

Bestehend aus (A - D) | Consists of (A - D)

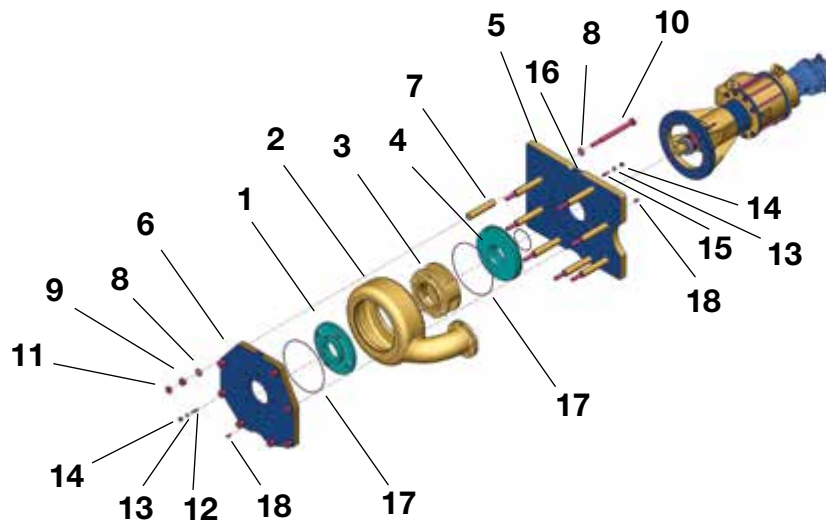

A

Darstellung Illustration	Bauer-Best.Nr. Bauer Item No.	Bezeichnung Description
1	1095465	(1x) Schleißplatte saugseitig Wear Plate Suction Side
2	1095466	(1x) Pumpengehäuse Pump Casing
3	1095468	(1x) Laufrad 2-Kanal Impeller 2 Channels
4	1095469	(1x) Schleißplatte antriebsseitig Wear Plate Power Unit
5	1186374	(1x) Gehäusedeckel antriebseitig Cover Driving End
6	1185693	(1x) Gehäusedeckel Cover
7	1119362	(8x) Distanzrohr Pipe/Tube
8	933057	(16x) Flache Scheibe m. Fase M 30 Plain Washer with Chamfer
9	202166	(8x) Sechskantmutter M 30 Hexagon Nut

Darstellung Illustration	Bauer-Best.Nr. Bauer Item No.	Bezeichnung Description
10	241585	(8x) Sechskantschraube M30x400 Hexagon Head Screw
11	14931	(8x) Sechskantmutter niedrig M 30 Hexagon Thin Nut
12	464394	(4x) Stiftschraube M 16 x 40 Stud
13	50028	(8x) Dubo-Sicherung f. M 16 Dubo-lock Washer
14	35180	(8x) Sechskantmutter M 16 Hexagon Nut
15	352331	(4x) Stiftschraube M 16 x 45 Stud
16	651580	(4x) Gewindestift I-6-kant M 24x35 Hexagon Socket Set Screw
17	20986	(2x) Fluidtechnik-O-Ring 420 x 4 Fluid Power System O-Ring
18	1139936	(8x) Gewindestift I-6-kant M 20x30 Hexagon Socket Set Screw

# Ersatzteile Schlitzwand

## Spare Parts Diaphragm Wall

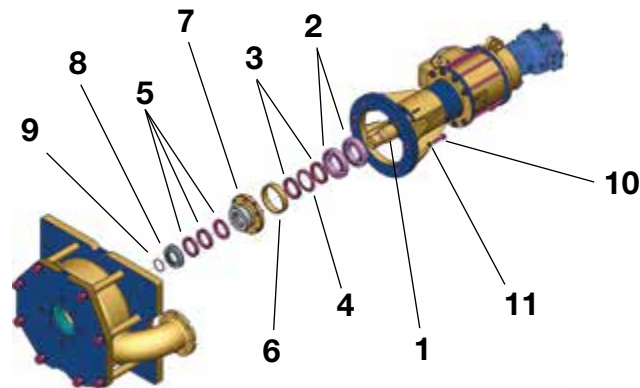

### B

Darstellung Illustration	Bauer-Best.Nr. Bauer Item No.	Bezeichnung Description
1	1191920	(1x) Pumpenwelle   <a href="#">Pump Shaft</a>
2	230930	(2x) Schrägkugellager   <a href="#">Ball Bearing</a>
3	33815	(2x) Nutmutter M 100 x 2   <a href="#">Groove Nut</a>
4	28152	(1x) Sicherungsblech   <a href="#">Locking Plate</a>
5	35265	(3x) Nutmutter M 90 x 2   <a href="#">Groove Nut</a>
6	19230	(1x) Distanzring 165   <a href="#">Spacer Ring</a>
7	1332776	(1x) Gleitringdichtung   <a href="#">Slide Ring Sealing</a>
8	1120493	(1x) Wellenschutzhülse   <a href="#">Protective Sleeve</a>
9	402115	(1x) Fluidtechnik-O-Ring 73 x 4   <a href="#">Fluid Power System O-Ring</a>
10	358664	(8x) Sechskantschraube Gew. bis Kopf M 20 x 70   <a href="#">Hexagon Head Screw</a>
11	375757	(8x) Sicherungsscheiben 20 selbsthemmend   <a href="#">Disk/Washer, Self Locking</a>

# Ersatzteile Schlitzwand

## Spare Parts Diaphragm Wall

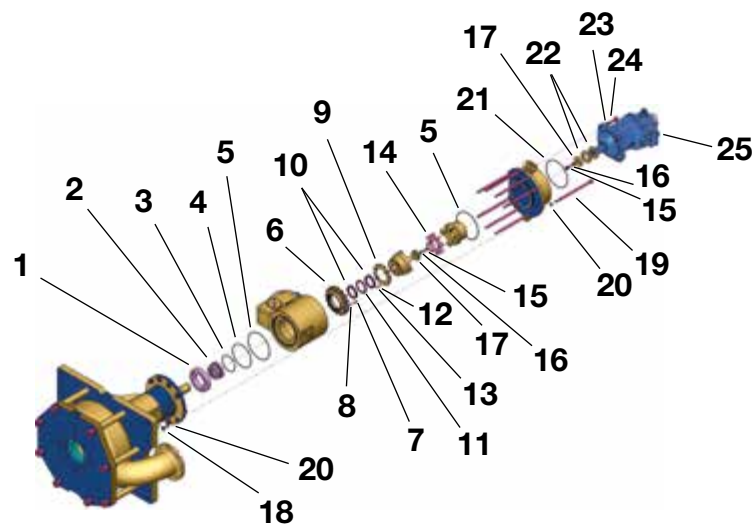

C

Darstellung Illustration	Bauer-Best.Nr. Bauer Item No.	Bezeichnung Description
1	229959	(1x) Zylinderrollenlager   <a href="#">Cylindrical Roller Bearing</a>
2	18937	(1x) Gleitringdichtung FP oben kpl.   <a href="#">Slide Ring Sealing FP upper</a>
3	86097	(1x) Fluidtechnik-O-Ring 122 x 4   <a href="#">Fluid Power System O-Ring</a>
4	20984	(1x) Fluidtechnik-O-Ring 180 x 4   <a href="#">Fluid Power System O-Ring</a>
5	21122	(2x) Fluidtechnik-O-Ring 210 x 5   <a href="#">Fluid Power System O-Ring</a>
6	19227	(1x) Flansch   <a href="#">Flange</a>
7	221045	(16x) Zyl. Schraube mit I-6-kant M 8 x 25   <a href="#">Hexagon Socket Head Cap Screw</a>
8	26698	(16x) Sicherungsscheibe 8 mm   <a href="#">Retaining Washer</a>
9	1120498	(1x) Zahnscheibe   <a href="#">Tooth Lock Washer</a>
10	12425	(2x) Nutmutter M 75 x 2   <a href="#">Groove Nut</a>
11	21817	(1x) Sicherungsblech für Nutmutter 75 x 104 x 1,5   <a href="#">Locking Plate for Groove Nu</a>

# Ersatzteile Schlitzwand

## Spare Parts Diaphragm Wall



Darstellung Illustration	Bauer-Best.Nr. Bauer Item No.	Bezeichnung Description
12	26697	(4x) Sicherungsscheibe 6   <a href="#">Retaining Washer</a>
13	48045	(4x) Zyl. Schraube mit I-6-kant M 6 X 12   <a href="#">Hexagon Socket Head Cap Screw</a>
14	50037	(1x) Zahnkranz für Klauenkupplung   <a href="#">Gear Ring for Claw Coupling</a>
15	527477	(2x) Zyl. Schraube mit I-6-kant M 16 x 40   <a href="#">Hexagon Socket Head Cap Screw</a>
16	24577	(2x) Sicherungsscheibe 16 mm   <a href="#">Retainig Washer</a>
17	46761	(2x) Deckel   <a href="#">Cover</a>
18	201984	(8x) Sechskantmutter M 16   <a href="#">Hexagon Nut</a>
19	242661	(8x) Sechskantschraube mit Schaft M 16 x 350   <a href="#">Hexagon Head Bolt</a>
20	24577	(16x) Sicherungsscheibe 16 mm   <a href="#">Retainig Washer</a>
21	402902	(1x) Fluidtechnik-O-Ring 210 x 4   <a href="#">Fluid Power System O-Ring</a>
22	19269	(2x) Distanzring 50,5   <a href="#">Spacer Ring</a>
23	375757	(4x) Sicherungsscheibe 20 selbsthemmend   <a href="#">Disc/Washer, Self-Locking</a>
24	44651	(4x) Sechskantschraube M 20 x 60   <a href="#">Hexagon Head Bolt</a>
25	1285620	(1x) Verstellmotor   <a href="#">Variable Motor</a>

# Ersatzteile Schlitzwand

## Spare Parts Diaphragm Wall

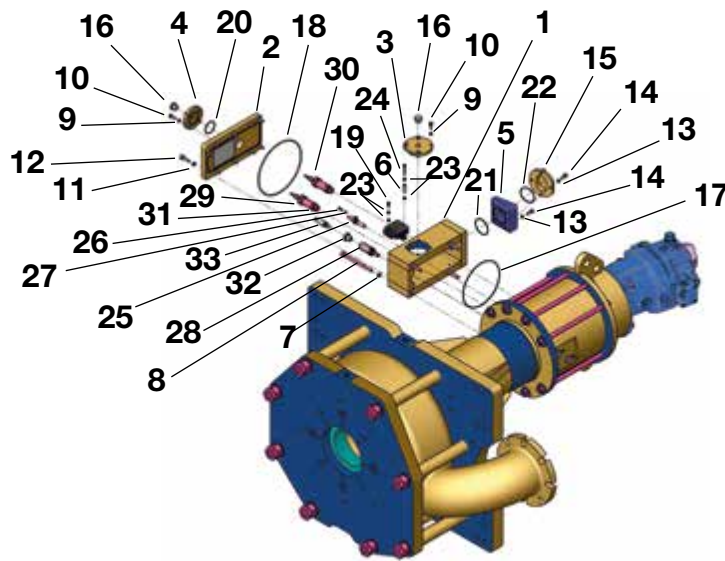

D

Darstellung Illustration	Bauer-Best.Nr. Bauer Item No.	Bezeichnung Description
1	1333645	(1x) Gehäuse s+b   <a href="#">Casing</a>
2	1187807	(1x) Deckel   <a href="#">Cover</a>
3	114933	(1x) Deckel   <a href="#">Cover</a>
4	655752	(1x) Socket   <a href="#">Socket</a>
5	1110411	(1x) Deckel   <a href="#">Cover</a>
6	1207803	(1x) Hülse   <a href="#">Sleeve</a>
7	24575	(4x) Sicherungsscheibe 12 mm   <a href="#">Retaining Washer</a>
8	15355	(4x) Zyl. Schraube mit I-6-kant M 12 x 140   <a href="#">Hexagon Socket Head Cap Screw</a>
9	611405	(8x) Sicherungsscheibe 8 mm   <a href="#">Retaining Washer</a>
10	212466	(8x) Sechskantschraube Gewinde bis Kopf M 8 x 20   <a href="#">Hexagon Head Screw</a>
11	24574	(11x) Sicherungsscheibe 10 mm   <a href="#">Hexagon Socket Head Cap Screw</a>
12	46018	(11x) Zyl. Schraube mit I-6-kant M 10 x 30   <a href="#">Hexagon Socket Head Cap Screw</a>
13	26698	(8x) Sicherungsscheibe 8 mm   <a href="#">Retaining Washer</a>
14	219833	(8x) Zyl. Schraube mit I-6-kant M 8 x 20   <a href="#">Hexagon Socket Head Cap Screw</a>

# Ersatzteile Schlitzwand

## Spare Parts Diaphragm Wall



Darstellung Illustration	Bauer-Best.Nr. Bauer Item No.	Bezeichnung Description
15	1110414	(1x) Deckel   <a href="#">Cover</a>
16	240607	(2x) Verschlusschraube 1/2"   <a href="#">Locking Screw</a>
17	402025	(1x) Fluidtechnik-O-Ring 182 x 4   <a href="#">Fluid Power System O-Ring</a>
18	977541	(1x) Fluidtechnik-O-Ring 215 x 4   <a href="#">Fluid Power System O-Ring</a>
19	1355656	(1x) Kreuzlochschaube mit Schlitz M 6 x 12   <a href="#">Slotted Capstan Screw</a>
20	44785	(1x) Fluidtechnik-O-Ring 45 x 3   <a href="#">Fluid Power System O-Ring</a>
21	40334	(1x) Fluidtechnik-O-Ring 59,99 x 2,62   <a href="#">Fluid Power System O-Ring</a>
22	617682	(1x) Fluidtechnik-O-Ring 58,42 x 2,62   <a href="#">Fluid Power System O-Ring</a>
23	16587	(4x) Flache Scheibe mit Fase M 6   <a href="#">Plain Washer with Chamfer</a>
24	254904	(1x) Zyl. Schraube mit I-6-kant, M 6 x 40   <a href="#">Hexagon Socket Head Cap Screw</a>
25	795845	(1x) El. Inst. Näherungsschalter mit 3-polig D-St   <a href="#">El. Inst. Proximity Switch w. 3 pole D-St</a>
26	48045	(1x) Zyl. Schraube mit I-6-kant M 6 x 12   <a href="#">Hexagon Socket Head Cap Screw</a>
27	26697	(1x) Sicherungsscheibe 6 mm   <a href="#">Hexagon Socket Head Cap Screw</a>
28	642295	(1x) Temperatur-/Wassersensor -40 – +130° C, M 12, kpl.   <a href="#">Temperature- /Water Sensor</a>
29	633469	(1x) Druckmessumformer M 12   <a href="#">Pressure Transformer</a>
30	762619	(1x) Druckmessumformer   <a href="#">Pressure Transformer</a>
31	364716	(1x) Kunststoffdichtung   <a href="#">Plastic Sealing</a>
32	230879	(1x) Reduzierung   <a href="#">Reduction</a>
33	1091318	(1x) Temperatursensor   <a href="#">Temperature Sensor</a>

# Ersatzteile Schlitzwand

## Spare Parts Diaphragm Wall

### Saugkasten | Suction Box

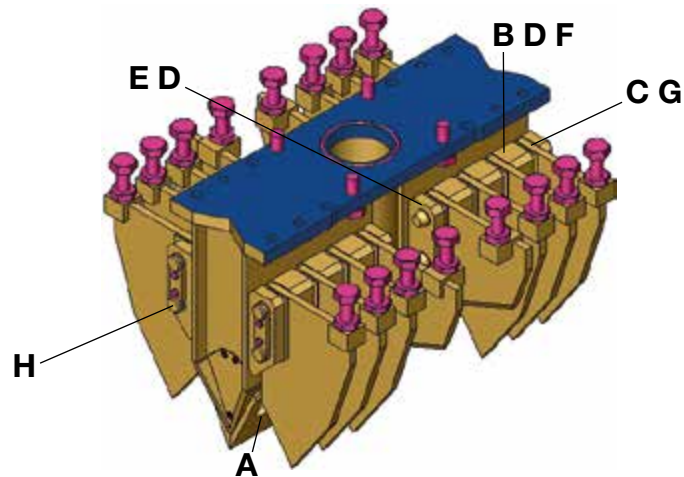

Darstellung Illustration	Bauer-Best.Nr. Bauer Item No.	Bezeichnung Description	Schlitzbreite in mm (Schlitzlänge 2800 mm) Trench Width in mm (Trench Length 2800 mm)				
			640	800	1000	1200	1500
A	135772	Saugkastenspitze   Suction Box Inlet Plate	1x				
A	130195	Saugkastenspitze   Suction Box Inlet Plate		1x			
A	130834	Saugkastenspitze   Suction Box Inlet Plate			1x		
A	131199	Saugkastenspitze   Suction Box Inlet Plate				1x	
A	138763	Saugkastenspitze   Suction Box Inlet Plate					1x
B	82410	Anschweißklotz 72   Welding Blocks	8x				
C	100730	Anschweißklotz 30 m. Gewinde   Welding Blocks w. Thread	4x	4x	4x		
D	210932	Anschweißklotz 68   Welding Blocks		8x	12x	4x	4x
E	103220	Anschweißklotz 30   Welding Blocks		4x	4x		
F	210931	Anschweißklotz 119   Welding Blocks				8x	12x
G	103258	Anschweißklotz 68 m. Gewinde   Welding Blocks w. Thread				4x	4x
H	46334	Bolzen   Bolt	8x				
H	82444	Bolzen   Bolt		8x			
H	55857	Bolzen   Bolt			8x		
H	57462	Bolzen   Bolt				8x	
H	12772	Bolzen   Bolt					8x

# Ersatzteile Schlitzwand

## Spare Parts Diaphragm Wall

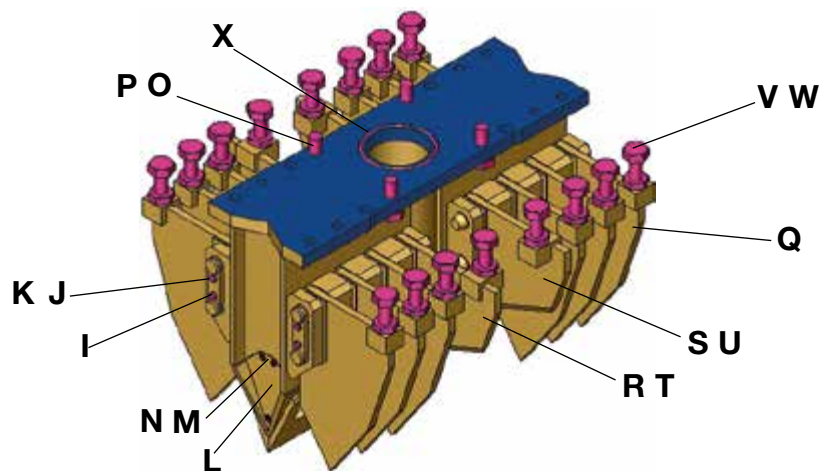







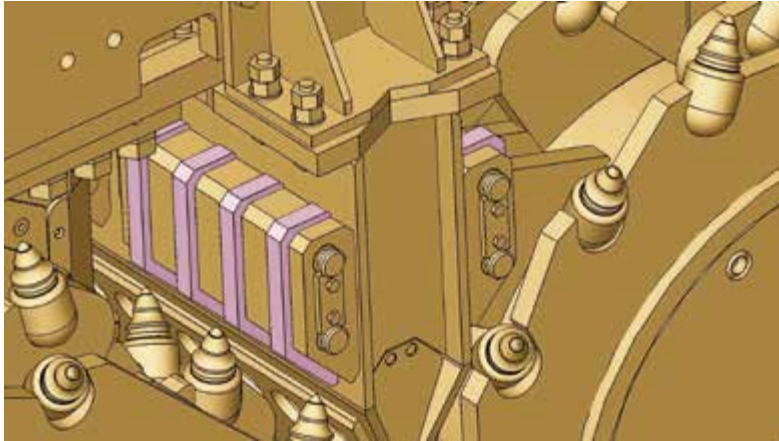

Darstellung Illustration	Bauer-Best.Nr. Bauer Item No.	Bezeichnung Description	Schlitzbreite in mm (Schlitzlänge 2800 mm) Trench Width in mm (Trench Length 2800 mm)				
			640	800	1000	1200	1500
I	82413	Achshalter   <a href="#">Suction Box Inlet Plate</a>	4x	4x	8x	8x	8x
J	227586	Schrauben Achshalter   <a href="#">Screws Axle Holder</a>	8x	8x	8x	8x	8x
K	24574	Sicherungsscheibe 10   <a href="#">Retaining Washer</a>	8x	8x	8x	8x	8x
L	210921	Deckel   <a href="#">Cover</a>	2x	2x	2x	2x	2x
M	26616	Schrauben Deckel   <a href="#">Screws Cover</a>	6x	6x	6x	6x	6x
N	24574	Sicherungsscheibe Deckel   <a href="#">Lock Washer Cover</a>	6x	6x	6x	6x	6x
O	27012	Schraube Saugkasten   <a href="#">Screws Suction Box</a>	4x	4x	4x	4x	4x
P	26701	Sicherungsscheibe Saugkasten   <a href="#">Lock Washer Suction Box</a>	4x	4x	4x	4x	4x
Q	1172809	Räumer s+b lang, 20 mm   <a href="#">Reamer Long</a>	4x	8x	12x	8x	12x
R	101394	Räumer s+b links, kurz, 20 mm   <a href="#">Reamer Left, Short</a>	2x	2x	2x		
S	101391	Räumer s+b rechts, kurz, 20 mm   <a href="#">Reamer Right, Short</a>	2x	2x	2x		
T	101389	Räumer s+b links, kurz   <a href="#">Reamer Left, Short</a>				2x	2x
U	101390	Räumer s+b rechts, kurz   <a href="#">Reamer Right, Short</a>				2x	2x
V	82678	Sechskantschraube   <a href="#">Hexagon Screw</a>	8x	12x	16x	12x	16x
W	813868	Sechskantmutter   <a href="#">Hexagon Nut</a>	8x	12x	16x	12x	16x
X	249192	O-Ring   <a href="#">O-Ring</a>	1x	1x	1x	1x	1x

# Ersatzteile Schlitzwand

## Spare Parts Diaphragm Wall

### Räumerersatz und Getriebeschild-Verschleißteile | Reamer Substitute and Wear Parts for Gear Shield



Darstellung Illustration	Bauer-Best.Nr. Bauer Item No.	Beschreibung / Verwendung Description / Application	Schlitzbreite (mm) Trench Width (mm)
	904970	Räumerersatz	640
	886948	für Fräsräder mit Rundschaftmeißeln	800
	904993	Reamerreplacement for Cutter Wheels with Round Shank Chisel	1000
	904994		1200
	1315422	Geteiltes Verschleißblech 2800 mm, Gewinde   Wear Plate, Thread	1500
	1315428	Geteiltes Verschleißblech 2800 mm, Senkung   Wear Plate, Reduction	1800
	1315078	Geteiltes Verschleißblech 3200 mm, Gewinde   Wear Plate, Thread	
	1315073	Geteiltes Verschleißblech 3200 mm, Senkung   Wear Plate, Reduction	
	1316637	Abweiserling 2800 mm, Ø 1395 mm, Senkung   Ring, Reduction	
	1316638	Abweiserling 2800 mm, Ø 1395 mm, Senkung   Ring, Reduction	
	1316640	Abweiserling 2800 mm, Ø 1395 mm, Gewinde   Ring, Thread	
	1316639	Abweiserling 2800 mm, Ø 1395 mm, Gewinde   Ring, Thread	
	1316879	Abweiserling 3200 mm, Ø 1595 mm, Senkung   Ring, Reduction	
	1316880	Abweiserling 3200 mm, Ø 1595 mm, Senkung   Ring, Reduction	
	1317043	Abweiserling 3200 mm, Ø 1595 mm, Gewinde   Ring, Thread	
	1317044	Abweiserling 3200 mm, Ø 1595 mm, Gewinde   Ring, Thread	





# Ersatzteile Schlitzwand

## Spare Parts Diaphragm Wall

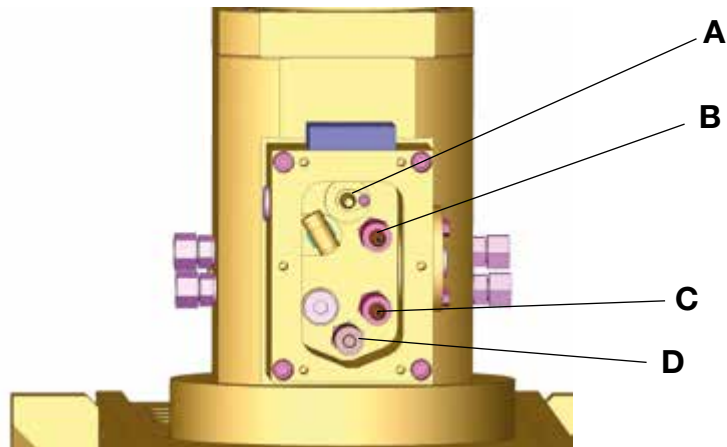

### Sensorik Fräsgetriebe | Sensoric Gear Box



Position Position	Darstellung Illustration	Bauer-Best.Nr. Bauer Item No.	Bezeichnung Description
A		795846	(1x) Drehzahl-Sensor Rotation Speed Sensor
B		759175	(1x) Druckaufnehmer PR 130, 2,5 bar Pressure Transformer
C		666098	(1x) Druckmessumformer 20 bar, M 12, 1/4" Pressure Transformer
D		642295	(1x) Temperatur-/Wassersensor -40 – +130 °C, M 12 kpl. Temperature/Water Sensor cpl.

# Ersatzteile Schlitzwand

## Spare Parts Diaphragm Wall

### Dichtungen Fräse | Cutter Sealings

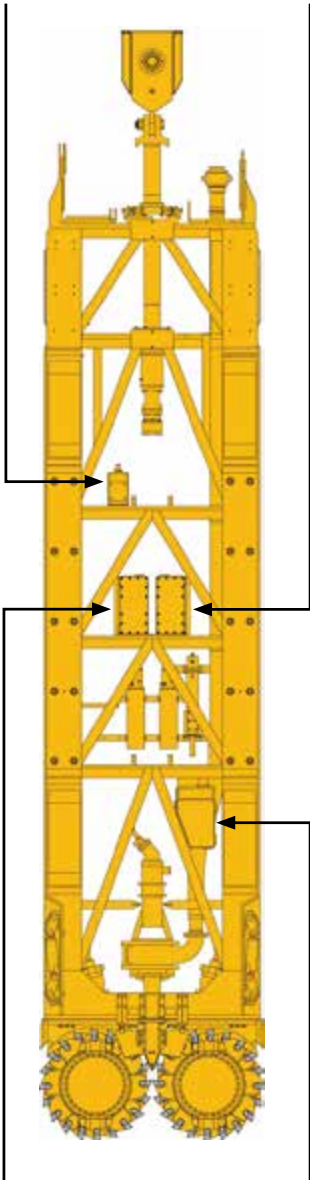
Darstellung Illustration	Bauer-Best.Nr. Bauer Item No.	Bauer-Best.Nr. Bauer Item No.	Bauer-Best.Nr. Bauer Item No.	Bezeichnung Description
	BC 32	BC 35	BC 40 ≤ # 309	
 <p>Elektrokasten klein Electric Box Small</p> <p>Hydraulikkasten links Hydraulic Box Left</p> <p>Hydraulikkasten rechts Hydraulic Box Right</p> <p>Elektrokasten groß Electric Box Big</p>	24153	24153	24153	Fluidtechnik-O-Ring für Elektrokasten klein Fluid Power System O-Ring for Electric Box Small
	644139	221262	644139	Fluidtechnik-O-Ring für Elektrokasten groß (Scharnierdeckel) Fluid Power System O-Ring for Electric Box Big (Hinged Lid)
	34270	860676	34270	Fluidtechnik-O-Ring für Elektrokasten groß (kleiner Deckel) Fluid Power System O-Ring for Electric Box Big (Small Lid)
	278320	278320	278320	Fluidtechnik-O-Ring für Hydraulikkasten rechts/links (Deckel) Fluid Power System O-Ring for Hydraulic Box Right/Left (Lid)
	278321	278321	278321	Fluidtechnik-O-Ring für Hydraulikkasten rechts/links (Anschlussplatte) Fluid Power System O-Ring for Hydraulic Box Right/Left (Bulkhead Plate)
	Bauer-Best.Nr. Bauer Item No.	Bauer-Best.Nr. Bauer Item No.	Bauer-Best.Nr. Bauer Item No.	Bezeichnung Description
	BC 40 ≥ # 310	BC 48	MBC 30	
	24153	32694	-	Fluidtechnik-O-Ring für Elektrokasten klein Fluid Power System O-Ring for Electric Box Small
	-	-	602135	Fluidtechnik-O-Ring für Elektrokasten groß (Scharnierdeckel) Fluid Power System O-Ring for Electric Box Big (Hinged Lid)
	20988	-	221262	Fluidtechnik-O-Ring für Elektrokasten groß (kleiner Deckel) Fluid Power System O-Ring for Electric Box Big (Small Lid)
	278320	1191781	644139	Fluidtechnik-O-Ring für Hydraulikkasten rechts/links (Deckel) Fluid Power System O-Ring for Hydraulic Box Right/Left (Lid)
	278321	278320	860320	Fluidtechnik-O-Ring für Hydraulikkasten rechts/links (Anschlussplatte) Fluid Power System O-Ring for Hydraulic Box Right/Left (Bulkhead Plate)



## **Generalüberholte Teile** *Reconditioned Parts*

Einige unserer Ersatzteile und Komponenten sind auch als generalüberholte Variante verfügbar. Unsere hochwertige Wiederaufbereitung garantiert beste Haltbarkeit zu günstigen Konditionen.

Bei Interesse wenden Sie sich bitte an Ihren Ersatzteil-Disponenten, der Sie über Preis und Verfügbarkeit informieren wird.

Auf generalüberholte Teile gewähren wir 12 Monate Mängelhaftung.

*Some of our parts and components are available as reconditioned alternative. Our high grade reconditioning process guarantees highest durability at reasonable conditions.*

*If we caught your interest please ask your spare parts sales manager/local service partner for price and availability.*





*These parts have a warranty period of 12 months.*

# Ersatzteile Schlitzwand

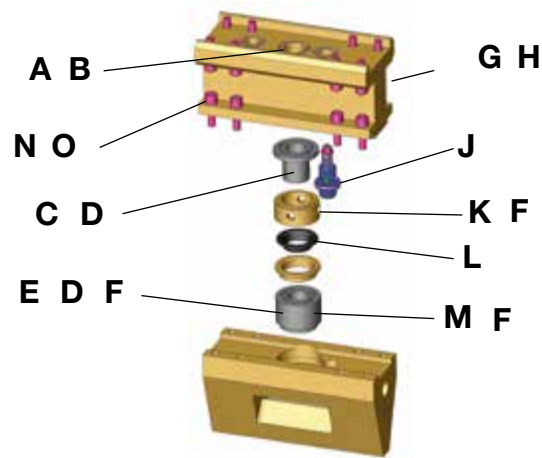
## Spare Parts Diaphragm Wall

### Suspensionsverteiler BCM 5 | Divider BCM 5











Position Position	Darstellung Illustration	Bauer-Best.Nr. Bauer Item No.	Bezeichnung Description
A		131872	(1x) Ring Ring
B		21243	(1x) Fluidtechnik-O-Ring 50 x 4 Fluid Power System O-Ring
C		422099	(1x) Düse mit Luft Nozzle with Air
D		21569	(2x) Fluidtechnik-O-Ring 54 x 4 Fluid Power System O-Ring
E		422094	(1x) Düse ohne Luft Nozzle without Air

# Ersatzteile Schlitzwand

## Spare Parts Diaphragm Wall



Position Position	Darstellung Illustration	Bauer-Best.Nr. Bauer Item No.	Bezeichnung Description
F		85388	(3x) Fluidtechnik-O-Ring 75 x 4 Fluid Power System O-Ring
G		131873	(2x) Ring Ring
H		37791	(2x) Fluidtechnik-O-Ring 38 x 4 Fluid Power System O-Ring
J		601044	(1x) Ventil kpl. Valve cpl.
K		422093	(1x) Distanzrohr Spacer Pipe
L		723165	(1x) Manschette Packing
M		422100	(1x) Verschleißring Wear Ring
N		232180	(16x) Zyl. Schraube mit I-6-kant M 16 x 50 Hexagon Socket Head Cap Screw
O		24577	(16x) Sicherungsscheibe 16 Retaining Washer

# Ersatzteile Schlitzwand

## Spare Parts Diaphragm Wall

### Suspensionsverteiler BCM 10 | Divider BCM 10

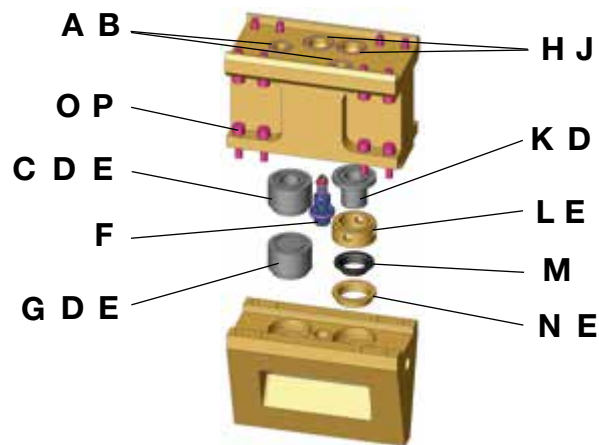









Position Position	Darstellung Illustration	Bauer-Best.Nr. Bauer Item No.	Bezeichnung Description
A		131873	(2x) Ring Ring
B		37791	(2x) Fluidtechnik-O-Ring 38 x 4 Fluid Power System O-Ring
C		422094	(1x) Düse ohne Luft Nozzle without Air
D		21569	(3x) Fluidtechnik-O-Ring 54 x 4 Fluid Power System O-Ring
E		85388	(4x) Fluidtechnik-O-Ring 75 x 4 Fluid Power System O-Ring
F		601044	(1x) Ventil kpl. Valve cpl.

# Ersatzteile Schlitzwand

## Spare Parts Diaphragm Wall



Position Position	Darstellung Illustration	Bauer-Best.Nr. Bauer Item No.	Bezeichnung Description
G		640128	(1x) Verschlussstopfel Lock
H		131872	(2x) Ring Ring
J		21243	(2x) Fluidtechnik-O-Ring 50 x 4 Fluid Power System O-Ring
K		422099	(1x) Düse mit Luft Nozzle with Air
L		422093	(1x) Distanzrohr Spacer Pipe
M		723165	(1x) Manschette Packing
N		422100	(1x) Verschleißring Wear Ring
O		356044	(16x) Zyl. Schraube mit I-6-kant M 16 x 55 Hexagon Socket Head Cap Screw
P		24577	(16x) Sicherungsscheibe 16 Retaining Washer



BE 300-C

BAUER CUBE SYSTEM

MAT

ST-30

ST-30

MAT



## Misch- und Trenntechnik Slurry Handling Systems









<b>Ersatzteile Misch- und Trenntechnik</b> <b>Spare Parts Slurry Handling Systems</b>	<b>176 - 201</b>
· Ersatzteile Entsandungsanlagen BE Spare Parts Desanding Plants BE	176 - 185
· Ersatzteile Mischanlagen CMS Spare Parts Continous Mixers CMS	186 - 188
· Ersatzteile Mischanlagen SK Spare Parts Continous Mixers SK	190 - 191
· Ersatzteile Mischanlagen SC Spare Parts Batch Mixers SC	192
· Ersatzteile Injektionsanlagen IP Spare Parts Injection Plants IP	193 - 195
· Ersatzteile Injektionsanlagen Obermann-MAT Spare Parts Injection Plants Obermann-MAT	196 - 199
· Ersatzteile Schlauchpumpen HP Spare Parts Hose Pumps HP	200
· Ersatzteile Exzentrerschneckenpumpen EP (ZA) Spare Parts Eccentric Screw Pumps EP (ZA)	201

# Ersatzteile Misch- und Trenntechnik

## Spare Parts Slurry Handling Systems









### Ersatzteile Entsandungsanlagen BE | Spare Parts Desanding Plants BE

Darstellung Illustration	Bauer-Best.Nr. Bauer Item No.	Stückzahlen (x) variabel wählbar Quantities (x) to be chosen	BE 100-60	BE 170-60	BE 250-60	BE 275-60	BE 300-60	BE 425-60
	MAT-Best.Nr. MAT Item No.							
	259834	Stecksieb 0,25 x 16 mm Screen Insert	X		X	X		X
	(9100005478)							
	218097	Stecksieb 0,40 x 16 mm Screen Insert	X	X	X	X		X
	(9100005230)							
	218096	Stecksieb 5 x 25 x 300 mm Screen Insert	X	X	X			X
	(9100005229)							
	278565	Stecksieb 0,16 x 5,65 mm Screen Insert	X		X			X
	(9100005505)							
	175567	Träger links L: 2980 Carrier Left						X
	(9100007412C2)							
	175568	Träger rechts L: 2980 Carrier Right						X
	(9100007413C2)							
	175569	Träger L: 2980 Carrier						X
	(9100007414C2)							

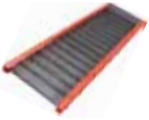
# Ersatzteile Misch- und Trenntechnik









## Spare Parts Slurry Handling Systems



Darstellung Illustration	Bauer-Best.Nr. Bauer Item No.	Stückzahlen (x) variabel wählbar Quantities (x) to be chosen	BE 100-60	BE 170-60	BE 250-60	BE 275-60	BE 300-60	BE 425-60
	MAT-Best.Nr. MAT Item No.							
	259681	Adapterleiste Adapter Bar	X		X	X		X
	(9100005477)							
	259680	Adapterleiste außen Adapter Bar Outside	X	X	X			X
	(9100005476)							
	278618	Drahtsiebbelag Wire Screen Lining	X		X	X		X
	(9100005506)							
	259679	Wangenschutzleiste Side Protection Bar	X	X	X	X		X
	(9100005475)							
	97665	Entwässerungsbelag 0,75 x 25 mm Dewatering Screen Mat			X	X		X
	(05100062A3)							
	376900	Träger Carrier	X		X			
	(9100006176)							
	376901	Träger links, L: 1980 Carrier Left Side			X			
	(9100006174)							
	376902	Träger rechts, L: 1980 Carrier Right Side			X			
	(9100006175)							

# Ersatzteile Misch- und Trenntechnik









## Spare Parts Slurry Handling Systems

Darstellung Illustration	Bauer-Best.Nr. Bauer Item No.	Stückzahlen (x) variabel wählbar Quantities (x) to be chosen	BE 100-60	BE 170-60	BE 250-60	BE 275-60	BE 300-60	BE 425-60
	MAT-Best.Nr. MAT Item No.							
	209818	Rohrbogen 90° Pipe Bend			X			
	(05101930A3)							
	489849	Reduzierstück kpl. Reducer cpl.			X	X		
	(05105428)							
	208806	Stutzen 3" für Zyklon 18" Spigot 3" for Cyclone 18"				X		
	(9100005156)							
	215783	Konus unten für Zyklon 18" Lower Cone for Cyclone 18"			X	X		X
	(9100005212)							
	391660	Keilriemen Lw: 2060 V-Belt			X			
	(9100008845)							
	254544	Gummiplatte Gleitblech Rubber Sheet			X			
	(05102279B3)							
	206968	Vortex Finder 6 1/2" Vortex Finder			X	X		
	(9100005147)							
	206971	Deflektorplatte 1" für Zyklon 18" Deflector Plate 1" for Cyclone 18"			X			X
	(9100005148)							

# Ersatzteile Misch- und Trenntechnik









## Spare Parts Slurry Handling Systems



Darstellung Illustration	Bauer-Best.Nr. Bauer Item No.	Stückzahlen (x) variabel wählbar Quantities (x) to be chosen	BE 100-60	BE 170-60	BE 250-60	BE 275-60	BE 300-60	BE 425-60
	MAT-Best.Nr. MAT Item No.							
	215780	Vorschubkasten für Zyklon 18" Feed Box for Cyclone 18"			X			X
	(9100005209)							
	215778	Überlaufrohr für Zyklon 18" Overflow Pipe for Cyclone 18"				X		X
	(9100007582)							
	1145253	Mittelstück für Zyklon 18" Center Piece for 18" Cyclone			X	X		X
	9100017798							
	234939	Verlängerung Vorschubkasten Feed Box Extension			X	X		X
	(9100005323)							
	215779	Deckel oben für Zyklon 18" Top Plate for Cyclone 18"			X	X		X
	(9100005208)							
	1171273	Kreiselpumpe 350 m³/h - 500 m³/h Centrifugal Pump						X
	(91000010676)							
	755345	Gehäuse Casing						X
	(9100013479)							
	755346	Pumpenrad Pump Wheel						X
	(9100013480)							

# Ersatzteile Misch- und Trenntechnik





## Spare Parts Slurry Handling Systems

Darstellung Illustration	Bauer-Best.Nr. Bauer Item No.	Stückzahlen (x) variabel wählbar Quantities (x) to be chosen	BE 100-60	BE 170-60	BE 250-60	BE 275-60	BE 300-60	BE 425-60
	MAT-Best.Nr. MAT Item No.							
	786905	Sperrkammerring Lock Chamber Ring						X
	(9100013483)							
	755348	Wellenschutzhülse Protective Sleeve						X
	(9100013484)							
	755349	Packungsring Package Ring						X
	(9100013485)							
	1101057	Scheibensatz Shim Set						X
	(9100013495)							
	786902	Dichtungssatz-Lager (B16, B19.1, B19.2, B22.1, B22.2) Sealing Kit Bearing						X
	(9100013501)							
	622197	Kreiselpumpe 150 – 250 m³/h Centrifugal Pump			X	X		
	(9100009597)							
	982198	Gehäuse W01 Casing			X	X		
	(9100010683)							
	982199	Pumpenrad Pump Wheel			X	X		
	(9100010684)							
	982332	Sperrkammerring Lock Chamber Ring			X	X		
	(9100010714)							



# Ersatzteile Misch- und Trenntechnik

## Spare Parts Slurry Handling Systems

Darstellung Illustration	Bauer-Best.Nr. Bauer Item No.	Stückzahlen (x) variabel wählbar Quantities (x) to be chosen	BE 100-60	BE 170-60	BE 250-60	BE 275-60	BE 300-60	BE 425-60
	MAT-Best.Nr. MAT Item No.							
	474519	Wellenschutzhülse Protective Sleeve			X	X		
	(9100010715)							
	474520	Packungsring Package Ring			X	X		
	(9100010716)							
	982343	Scheibe Disk/Washer			X	X		
	(9100010725)							
	474568	Dichtungssatz Sealing Kit			X	X		
	(9100017254)							
	524453	Packungsentferner Package Eliminator			X	X		
	(9100011759)							

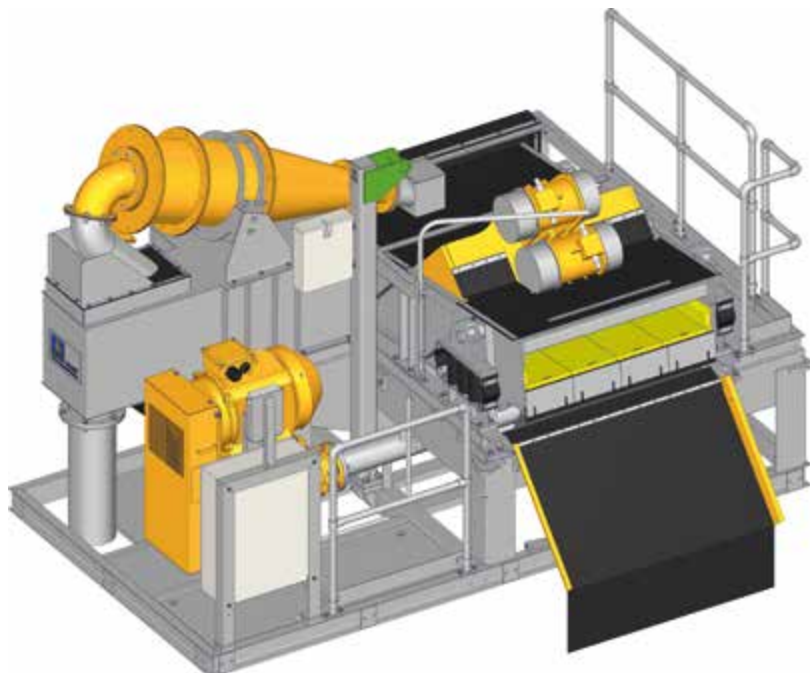

# Ersatzteile Misch- und Trenntechnik











## Spare Parts Slurry Handling Systems

Darstellung Illustration	Bauer-Best.Nr. Bauer Item No.	Stückzahlen (x) variabel wählbar Quantities (x) to be chosen	BE 100-60	BE 170-60	BE 250-60	BE 275-60	BE 300-60	BE 425-60
	MAT-Best.Nr. MAT Item No.							
	1359374	Sieb 0,5 x 11,5 mm 1000 x 300 MATmesh Screen	X	X	X	X	X	X
	1367537	Sieb 0,3 x 11,5 mm 1000 x 300 MATmesh Screen	X	X	X	X	X	X
	1274180	Sieb 0,3 x 16 mm 470 x 300 MATmesh Screen	X	X	X	X	X	X
	1369114	Sieb 0,2 x 11,5 mm 470 x 300 MATmesh Screen	X	X	X	X	X	X
	1274172	Sieb 2 x 16 mm 1000 x 300 MATmesh Screen	X	X	X	X	X	X
	1274173	Sieb 2 x 16 mm 470 x 300 MATmesh Screen	X	X	X	X	X	X
	1274179	Sieb 0,5 x 16 mm 470 x 300 MATmesh Screen	X	X	X	X	X	X
	1274175	Sieb 5,5 x 5,5 mm 1000 x 300 MATmesh Screen	X	X	X	X	X	X
	1294122	Sieb 4 x 16 mm 1000 x 300 MATmesh Screen	X	X	X	X	X	X
	1293714	Sieb Draht 4 x 50 mm 1000 x 300 MATmesh Screen Wire	X	X	X	X	X	X
	1298396	Sieb 7,5 x 7,5 mm 1000 x 300 MATmesh Screen	X	X	X	X	X	X

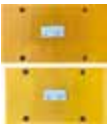











# Ersatzteile Misch- und Trenntechnik

## Spare Parts Slurry Handling Systems

Darstellung Illustration	Bauer-Best.Nr. Bauer Item No.	Stückzahlen (x) variabel wählbar Quantities (x) to be chosen	BE 100-60	BE 170-60	BE 250-60	BE 275-60	BE 300-60	BE 425-60
	MAT-Best.Nr. MAT Item No.							
	1274182	Sieb 0,7 x 16 mm 1000 x 300 MATmesh Screen	X	X	X	X	X	X
	1298398	Sieb Rueckwand 0,75 x 25 mm 1000 MATmesh Screen Back Panel	X	X	X	X	X	X
	1298397	Sieb Rueckwand 2 x 25 mm 1000 MATmesh Screen Back Panel	X	X	X	X	X	X
	1317365	Sieb Rückwand 0,75 x 25 mm 595 MATmesh Screen Back Panel	X	X	X	X	X	X
	1317369	Sieb Rückwand ohne Lochung 595 MATmesh Screen Back Panel w/o Perforation	X	X	X	X	X	X
	1317422	Sieb Rückwand ohne Lochung 625 MATmesh Screen Back Panel w/o Perforation	X	X	X	X	X	X
	1289122	Sieb Adapterleiste 1000 MATmesh Screen Adapter Bar	X	X	X	X	X	X
	1289124	Sieb Adapterleiste 470 MATmesh Screen Adapter Bar	X	X	X	X	X	X
	1287891	Sieb Seitenleiste 1000 MATmesh Screen Side Bar	X	X	X	X	X	X
	1287895	Sieb Seitenleiste 470 MATmesh Screen Side Bar	X	X	X	X	X	X
	1274171	Sieb Seitenleiste 0,7 x 16 mm 1000 MATmesh Screen Side Bar	X	X	X	X	X	X

# Ersatzteile Misch- und Trenntechnik









## Spare Parts Slurry Handling Systems

Darstellung Illustration	Bauer-Best.Nr. Bauer Item No.	Stückzahlen (x) variabel wählbar Quantities (x) to be chosen	BE 100-60	BE 170-60	BE 250-60	BE 275-60	BE 300-60	BE 425-60
	MAT-Best.Nr. MAT Item No.							
	1274170	Sieb Seitenleiste 0,7 x 16 mm 470 MATmesh Screen Side Bar	X	X	X	X	X	X
	1274183	Sieb Abweiser Screen Deflector	X	X	X	X	X	X
	1319129	Zyklon 20" Cyclone					X	
	1354546	Überlaufdüse ZF 5A a Overflow Nozzle					X	
	1354551	Zulaufstück Inlet					X	
	1354549	Konus ZW 92 Cone					X	
	1354553	Konus AI 92 Cone					X	
	1354545	Überlaufdüse AI 5C Overflow Nozzle					X	
	1354552	Einlaufstück AI 1A Inlet					X	
	1354542	Ablaufkasten Hydrozyklon Outlet Hydro Cyclone					X	



# Ersatzteile Misch- und Trenntechnik









## Spare Parts Slurry Handling Systems

Darstellung Illustration	Bauer-Best.Nr. Bauer Item No.	Stückzahlen (x) variabel wählbar Quantities (x) to be chosen	BE 100-60	BE 170-60	BE 250-60	BE 275-60	BE 300-60	BE 425-60
	MAT-Best.Nr. MAT Item No.							
	1325705	Prallkasten Impact Box					X	
	1354543	Apex ZW 94 A Apex					X	
	1354547	Konusverlängerung ZF 99 a Cone Extension					X	
	1354548	Einlaufstück ZFT 1 B Inlet					X	
	1119098	Unterlauf Tasche F 69 kurz Under Flow Bag					X	
	464941	Gelenkbolzenschelle GBS M 91-97/25 SK Hinge Pin Clamp					X	
	1303241	Kreiselpumpe 350 m <sup>3</sup> /h - 500 m <sup>3</sup> /h Centrifugal Pump					X	
	1020833	Taper-Buchse 2517, Ø 60 mm Taper Bush					X	
	1032621	Taper-Buchse 3535, Ø 70 mm Taper Bush					X	
	391660	Keilriemen Lw: 2060 (Empfohlen 8 St.) V-Belt (recommended 8 pc.)					X	

# Ersatzteile Misch- und Trenntechnik

## Spare Parts Slurry Handling Systems











### Ersatzteile Mischanlagen CMS | Spare Parts Continuous Mixers CMS

Darstellung Illustration	Bauer-Best.Nr. Bauer Item No.	Stückzahlen (x) variabel wählbar Quantities (x) to be chosen	CMS 30	CMS 45
	MAT-Best.Nr. MAT Item No.	Bezeichnung Description		
	1339656	Drossel Schalldämpfer GRU-1/4-B Throttle Silencer	X	X
	1339351	Rotationsreiniger kpl. Rotation Cleaner	X	X
	656424	Schlauch-Quetschventil DN 125 Hose Pinch Valve		X
	823992	Manschette DN 125 Sleeve		X
	437147	Schlauch-Quetschventil DN 100 Hose Pinch Valve	X	
	416905	Manschette DN 100 Sleeve	X	
	1252593	Klappe DN 200 und Antrieb FS 052 Flap and Valve	X	X
	1250869	Klappe DN 80, Antrieb FS 015 und Ventil Flap, Drive and Valve	X	X
	603066	Filterschlauch DN 250 Filter Hose	X	X

# Ersatzteile Misch- und Trenntechnik









## Spare Parts Slurry Handling Systems



Darstellung Illustration	Bauer-Best.Nr. Bauer Item No.	Stückzahlen (x) variabel wählbar Quantities (x) to be chosen	CMS 30	CMS 45
	MAT-Best.Nr. MAT Item No.	Bezeichnung Description		
	1248616	Wägemodul 52-18 Gleitlagersystem Weighing Module, Plain Bearing System	X	X
	1289897	Radarsensor Radar Sensor	X	X
	1274299	MST-Zahnriemen 2400-8M-85 MST Toothed Belt		X
	1223066	HTD-Zahnriemen 2400-8M-85 HTD Toothed Belt	X	
	1323977	Klappschwimmerschalter 207 KS Float Switch	X	X
	378617	Gummi-Manschette 220 x 2 x 1000 mm Rubber Sleeve	X	X
	1251775	Auslauf Y-Stück 5" SBG Outlet Y-Piece		X
	1273770	Auslauf Y-Stück 4" SBG Outlet Y-Piece	X	
	1319194	Umpumpleitung 1150 mm Lw: 150 x 10 Circulation Pipe		X
	1274103	Spiral-Saugschlauch Lw: 110 x 7 Spiral Suction Hose	X	

# Ersatzteile Misch- und Trenntechnik

## Spare Parts Slurry Handling Systems









Darstellung Illustration	Bauer-Best.Nr. Bauer Item No.	Stückzahlen (x) variabel wählbar Quantities (x) to be chosen	CMS 30	CMS 45
	MAT-Best.Nr. MAT Item No.	Bezeichnung Description		
	1308913	Mischpaddel CMS Ø 8 mm, t = 4 mm Mixing Paddle CMS	X	X
	1293473	Lagerung kpl. Bearing cpl.	X	X
	772334	Druckerhöhungspumpe 3,0 kW Booster Pump	X	X
	1021367	Sicherheits-Sensor Safety Sensor	X	X
	1275698	Drehstrommotor 22 kW IE 3 400 V - 50 Hz / 460 V - 60 Hz Three-Phase Motor	X	
	1123297	Drehstrommotor 30 kW IE 3 400 V - 50 Hz / 460 V - 60 Hz Three-Phase Motor		X
	1253834	Niro-Sieb (in der Wasserleitung zur Druckerhöhungspumpe) Niro-strainer (in the water supply to booster pump)	X	X
	1222942	3/2-Wege Magnetventil 24 V DC 3/2-way Magnetic Valve	X	X



# Ersatzteile Misch- und Trenntechnik

## Spare Parts Slurry Handling Systems









### Ersatzteile Mischanlagen SK | Spare Parts Continuous Mixers SK

Darstellung Illustration	Bauer-Best.Nr. Bauer Item No.	Stückzahlen (x) variabel wählbar Quantities (x) to be chosen	SKC-60	SKA-60	SKC-30	SKA-30
	MAT-Best.Nr. MAT Item No.					
	406786	Flachdichtung Lageraufsatz Flat Sealing Bearing Seat	X	X		
	(06001363A4)					
	406785	Flachdichtung Ø 800 mm Flat Sealing	X	X		
	(9090011389)					
	355164	Flachdichtung Ø 460 mm Flat Sealing			X	X
	(9090010435)					
	411370	Flachdichtung Ø 600 mm Flat Sealing			X	X
	(9100004602)					
	406784	Dichtung-Wartungsdeckel Sealing Maintenance Lid	X	X	X	X
	(9090011233)					
	408217	Laufwerkichtung 56,2 x 82,55 x 22,86 Drive Sealing	X	X	X	X
	(9090010493)					
	973213	Abstreifer Wiper			X	X
	(06000154D2)					
	406782	Abstreifer Wiper	X	X		
	(06001352A2)					
	445481	Flanschzylinder Cylinder			X	X
	(07008407)					

# Ersatzteile Misch- und Trenntechnik

## Spare Parts Slurry Handling Systems







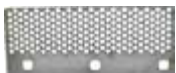

Darstellung Illustration	Bauer-Best.Nr. Bauer Item No.	Stückzahlen (x) variabel wählbar Quantities (x) to be chosen	SKC-60	SKA-60	SKC-30	SKA-30
	MAT-Best.Nr. MAT Item No.	Bezeichnung Description				
	212544	Zahnriemen 2000-8M-50			X	X
	(9090010101)	Toothed Belt				
	1223066	Zahnriemen 2400-8M-85	X	X		
	(9090010211)	Toothed Belt				
	94071	Ankerschraube	X	X	X	X
	(06000080A4)	Anchor Screw				
	377813	Mischpaddel	X	X	X	X
	(06000087A3)	Mixing Paddle				
	94074	Klemmschelle für Lochblech	X	X	X	X
	(06000091A4)	Clamp for Perforated Plate				
	606552	Winkel für Lochblech	X	X	X	X
	(06000110A4)	Elbow for Perforated Plate				
	406777	Distanzrohr	X	X	X	X
	(06000112A4)	Spacer Pipe				
	422157	Siebgewebe	X	X	X	X
	(06002126A4)	Sieve Netting				

# Ersatzteile Misch- und Trenntechnik

## Spare Parts Slurry Handling Systems

### Ersatzteile Mischanlagen SC | Spare Parts Batch Mixers SC







Darstellung Illustration	Bauer-Best.Nr. Bauer Item No.	Stückzahlen (x) variabel wählbar Quantities (x) to be chosen	SCA-30-K	SCA-20-K	SCC-20-K
	MAT-Best.Nr. MAT Item No.				
	1223066	Zahnriemen 2400-8M-85 Toothed Belt		X	X
	(9090010211)				
	437049	Mischpaddel Mixing Paddle	X	X	X
	(07009164B4)				
	437147	Schlauch Quetschventil Hose Pinch Valve	X	X	X
	(9090010686)				
	1020637	Flachdichtung Ø 100 mm Flat Sealing	X	X	X
	(9081610500)				
	416905	Manschette Ø 100 mm Sleeve	X	X	X
	(9100001035)				
	379353	Flachstrahldüse 20° Flat Jet Nozzle	X	X	X
	(9100002389)				
	406785	Flachdichtung Ø 800 mm Flat Sealing	X	X	X
	(9090011389)				



# Ersatzteile Misch- und Trenntechnik







## Spare Parts Slurry Handling Systems

### Ersatzteile Injektionsanlagen IP | Spare Parts Injection Plants IP

Darstellung Illustration	Bauer-Best.Nr. Bauer Item No.	Stückzahlen (x) variabel wählbar Quantities (x) to be chosen	IPC-180-E/D	IPC-100-E/D	IPC-60-E/D
	MAT-Best.Nr. MAT Item No.				
	605129	Gleitscheibe Sliding Disk	X		
	(07005503A2)				
	605130	Axial-Wellendichtring V-95A Axial Shaft Seal	X		
	(9100007190)				
	605131	Axial-Wellendichtring V-120A Axial Shaft Seal	X		
	(9100007191)				
	649842	Axial-Wellendichtring V-170A Axial Shaft Seal	X		
	(9100007192)				
	690814	Ventilsitz K60 aus Werkzeugstahl Valve Seat	X		
	(07012933B4)				
	377851	Plungermantel 110/300 Plunger Cover	X		
	(07003294A4A4)				
	379282	Stahlkugel Ø 60 mm Steel Ball	X		
	(9100001458)				

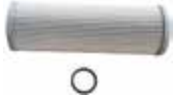
# Ersatzteile Misch- und Trenntechnik









## Spare Parts Slurry Handling Systems

Darstellung Illustration	Bauer-Best.Nr. Bauer Item No.	Stückzahlen (x) variabel wählbar Quantities (x) to be chosen	IPC-180-E/D	IPC-100-E/D	IPC-60-E/D
	MAT-Best.Nr. MAT Item No.	Bezeichnung Description			
	411239	Nutring ID: 110 mm Grooved Ring	X		
	(9100004198A)				
	411237	Stangendichtung ID: 110 mm Rod Sealing	X		
	(9100003992)				
	411238	Führungsring ID: 110 mm Guide Ring	X		
	(9100003993)				
	379358	Filterpatrone für TEF 120 Filter Cartridge	X		
	(9100002510)				
	709606	Ventilsitz Valve Seat	X		
	(07014117A3)				
	379282	Stahlkugel Ø 60 mm Steel Ball	X		
	(9100001458)				
	463457	Gleitscheibe Sliding Disk		X	X
	(07008394B3)				
	463439	Axial-Wellendichtring V-55A Axial Shaft Seal		X	X
	(9100009459)				

# Ersatzteile Misch- und Trenntechnik

## Spare Parts Slurry Handling Systems



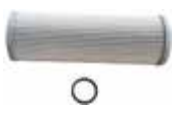



Darstellung Illustration	Bauer-Best.Nr. Bauer Item No.	Stückzahlen (x) variabel wählbar Quantities (x) to be chosen	IPC-180-E/D	IPC-100-E/D	IPC-60-E/D
	MAT-Best.Nr. MAT Item No.				
	936874	Axial-Wellendichtring V-75A <a href="#">Axial Sealing Ring</a>		X	X
	(9100015649)				
	605131	Axial-Wellendichtring V-120A <a href="#">Axial Shaft Seal</a>		X	X
	(9100007191)				
	605842	Ventilsitz K50 <a href="#">Valve Seat</a>		X	X
	(07012709A3)				
	905962	Ventilgehäuse <a href="#">Valve Housing</a>		X	X
	(07011096A3)				
	462684	Stahlkugel Ø 50 mm <a href="#">Steel Ball</a>		X	X
	(9100002805)				
	463429	Nutring ID: 90 mm <a href="#">Grooved Ring</a>		X	X
	(9100007875)				
	463430	Stangendichtung ID: 90 mm <a href="#">Rod Sealing</a>		X	X
	(9100007876)				
	463431	Führungsring Ø 90 mm <a href="#">Guide Ring</a>		X	X
	(9100007877)				
	379358	Filterpatrone für TEF 120 <a href="#">Filter Cartridge</a>		X	X
	(9100002510)				

# Ersatzteile Misch- und Trenntechnik

## Spare Parts Slurry Handling Systems







### Ersatzteile Injektionsanlagen Obermann-MAT | Spare Parts Injection Plants Obermann-MAT

Darstellung Illustration	Bauer-Best.Nr. Bauer Item No.	Stückzahlen (x) variabel wählbar Quantities (x) to be chosen	VS 63	VS 110	AVS 110	VS 121
	MAT-Best.Nr. MAT Item No.					
-	1084906	Dichtsatz Linearantrieb DP 70/100 Seal Kit for Linear Actuator		X	X	
	(001341101141)					
-	1084908	Dichtsatz DP 101 Förderenteil Seal Kit DP 101 Conveyor Part		X	X	
	(001341101142)					
-	1084909	Dichtsatz DP 101 Kugelsaugventil Seal Kit, Suction Valve		X	X	
	(001341101143)					
-	1084910	Dichtsatz DP 101 Kugeldruckventil Seal Kit, Suction Valve		X	X	
	(001341101144)					
	1329726	Plungerhülse Plunger Sleeve		X	X	
	(001341101022)					
	1290829	O-Ring 82,1 x 3,53 O-Ring		X	X	
	(005010821353)					
	1290827	O-Ring 17 x 3,53 O-Ring		X	X	
	(005010170353)					
	1290835	USIT-Ring 17,4 x 24 x 1,5 USIT-Ring		X	X	
	(007500174015)					

# Ersatzteile Misch- und Trenntechnik







## Spare Parts Slurry Handling Systems

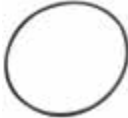

Darstellung Illustration	Bauer-Best.Nr. Bauer Item No.	Stückzahlen (x) variabel wählbar Quantities (x) to be chosen	VS 63	VS 110	AVS 110	VS 121
	MAT-Best.Nr. MAT Item No.					
	1290102	Kugelsaugventil DN 50 kpl. Ball Suction Valve DN 50 cpl.		X	X	
	(001341101145)					
	1047730	Saugventilsitz kpl. Suction Valve Seat cpl.		X	X	
	(001351200060)					
	1290840	Radialführungsring Radial Guide Ring		X	X	X
	(001351200059)					
	1047746	Stahlkugel Ø 60 mm Steel Ball		X	X	
	(001970004060)					
	1329617	Kugeldruckventil kpl. Ball Pressure Valve cpl.		X	X	
	(001341101050)					
	1084931	Druckventilsitz DP 101 Pressure Valve Seat	X	X	X	
	(001341075029)					
	1094110	Radialführungsring Radial Guide Ring	X	X	X	
	(001341075026)					

# Ersatzteile Misch- und Trenntechnik

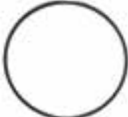





## Spare Parts Slurry Handling Systems

Darstellung Illustration	Bauer-Best.Nr. Bauer Item No.	Stückzahlen (x) variabel wählbar Quantities (x) to be chosen	VS 63	VS 110	AVS 110	VS 121
	MAT-Best.Nr. MAT Item No.	Bezeichnung Description				
	1047748	Stahlkugel Ø 50 mm	X	X	X	
	(001970004050)	Steel Ball				
	1347343	Stopfbuchse zum Getriebe		X	X	
	(001480168102)	Gland Packing				
	1342621	O-Ring 85 x 18 Moosgummi		X	X	
	(005000850180)	O-Ring Foam Rubber				
	1290107	O-Ring 202,5 x 5,33		X	X	
	(005012025533)	O-Ring				
	1333412	O-Ring 234,3 x 5,33		X	X	
	(005012343533)	O-Ring				
	1341786	O-Ring 101,1 x 3,53		X	X	
	(005011011353)	O-Ring				
	1341914	O-Ring Ø 50 mm für Schnellkupplung		X	X	
	(008010000050)	O-Ring for Quick Coupling				

# Ersatzteile Misch- und Trenntechnik

## Spare Parts Slurry Handling Systems





Darstellung Illustration	Bauer-Best.Nr. Bauer Item No.	Stückzahlen (x) variabel wählbar Quantities (x) to be chosen	VS 63	VS 110	AVS 110	VS 121
	MAT-Best.Nr. MAT Item No.	Bezeichnung Description				
	1285209	O-Ring 78,9 x 3,53		X	X	
	(005010789353)	O-Ring				
	1333209	Stangendichtung ID: 18 mm		X	X	
	(005350180003)	Rod Sealing				
	1290828	O-Ring 28,3 x 1,78		X	X	
	(005010283178)	O-Ring				
	1341886	O-Ring 60 x 1,78		X	X	
	(005010600178)	O-Ring				
	1285189	Dichtung Moosgummi		X	X	
	(001700000035)	Foam Rubber Seal				
	1333414	Dichtung Ø 24 x 8 x 5		X	X	
	(007510240050)	Sealing				
	1290104	Rundschnur Dichtung Ø 150 mm		X	X	
	(001341111143)	Round Cord Seal				

# Ersatzteile Misch- und Trenntechnik

## Spare Parts Slurry Handling Systems

### Ersatzteile Schlauchpumpen HP | Spare Parts Hose Pumps HP







Darstellung Illustration	Bauer-Best.Nr. Bauer Item No.	Stückzahlen (x) variabel wählbar Quantities (x) to be chosen	HP-70-E	HP-50-E	HP-30-E	HP-15-E
	MAT-Best.Nr. MAT Item No.	Bezeichnung Description				
	275347	Pumpenschlauch HP 50/70 Typ A	X	X		
	(9090011230)	Pump Hose Type A				
	275346	Pumpenschlauch HP-15, 10 bar				X
	(9090011205)	Pump Hose				
	269802	Pumpenschlauch HP-30, 10 bar, Typ A			X	
	(9090010922)	Pump Hose Type A				
	374881	Näherungsschalter	X	X	X	X
	(9089113507)	Proximity Switch				

# Ersatzteile Misch- und Trenntechnik

## Spare Parts Slurry Handling Systems



### Ersatzteile Exzentrerschneckenpumpen EP (ZA) | Spare Parts Eccentric Screw Pumps EP (ZA)

Darstellung Illustration	Bauer-Best.Nr. Bauer Item No.	Stückzahlen (x) variabel wählbar Quantities (x) to be chosen	EP-14-400	EP-14-600
	MAT-Best.Nr. MAT Item No.			
	1104691	Rotor B Rotor	X	
	(9100018614)			
	1104692	Stator für STP-2 Stator	X	
	(9100018836)			
	885288	Packingring Packing Ring	X	X
	(9100018616)			
	1104694	Packingzieher Packing Collar	X	
	(9100018617)			
	1123884	Rotor-B Rotor		X
	(9100018788)			
	1123885	Stator für STP-2 Stator		X
	(9100018789)			



## Single-Pass-Verfahren Single Pass Methods

---



Verfahrensausrüstung und Zubehör Methods Equipment and Accessories	204 - 211
· Verbindungselemente Single-Pass Coupling Components Single Pass	204 - 206
· Ersatzteile Single-Pass-Verfahren Spare Parts Single Pass Methods	208 - 209
· Betonierzubehör DKS/SOB Concrete Accessories DKS/CFA	210
· Ersatzteile Tiefenrüttler Spare Parts Deep Vibrators	211

# Verfahrensausrüstung und Zubehör Methods Equipment and Accessories

## Verbindungselemente Single-Pass | Coupling Components Single-Pass

**Ø 254**  
(DKS / CFA / FDP)



Darstellung Illustration		Darstellung Illustration		Darstellung Illustration	
Bauer-Best.Nr. Bauer Item No.	Bezeichnung Description	Bauer-Best.Nr. Bauer Item No.	Bezeichnung Description	Bauer-Best.Nr. Bauer Item No.	Bezeichnung Description
					Bauer-ID: 127942
121823	Mutterteil Verbinder Female Coupling	125511	Vaterteil Verbinder Male Coupling	39777	(1x) O-Ring (144/8)
				38734	(3x) Hülse   Bushing
				203120	(3x) Schraube   Screw
				39956	(6x) Keile   Wedge

**Ø 368**  
(DKS / CFA / FDP /  
Lost Bit / SCM)



Darstellung Illustration		Darstellung Illustration		Darstellung Illustration	
Bauer-Best.Nr. Bauer Item No.	Bezeichnung Description	Bauer-Best.Nr. Bauer Item No.	Bezeichnung Description	Bauer-Best.Nr. Bauer Item No.	Bezeichnung Description
					Bauer-ID: 383191 (DKS / CFA / FDP)  Lost Bit: ID: 520820 Lost Bit * SCM **
384775	Mutterteil Verbinder Female Coupling	384776	Vaterteil Verbinder Male Coupling	39328	(2x) O-Ring (250/8)
				26776	(2x) O-Ring (132/5)
				48154	(1x) O-Ring (300/10)
				803918	(1x) Deckel   Top Cover
				365432	(2x) Gliederband Wedge Chain

\* Verbindungselement Lost Bit | Connecting Element: ID: 520820

\*\* Verbindungselement SCM | Connecting Element: ID: 1146290



# Verfahrens-ausrüstung und Zubehör

## Methods Equipment and Accessories



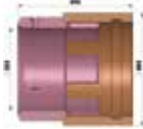
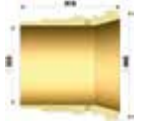

**Ø 445**  
(DKS / CFA / FDP)



Darstellung Illustration		Darstellung Illustration		Darstellung Illustration	
Bauer-Best.Nr. Bauer Item No.	Bezeichnung Description	Bauer-Best.Nr. Bauer Item No.	Bezeichnung Description	Bauer-Best.Nr. Bauer Item No.	Bezeichnung Description
					 Bauer-ID: 383110
1372046	Mutterteil Verbinder Female Coupling	1348474	Vaterteil Verbinder Male Coupling	26776	(2x) O-Ring (132/5)
				38202	(2x) O-Ring (340/6)
				60339	(1x) O-Ring (380/10)
				12944	(1x) Deckel   Top Cover
				16585	(2x) Schraube   Screw
				437386	(2x) Gliederband Wedge Chain

**Ø 445**  
(Lost Bit)

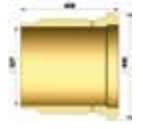



Darstellung Illustration		Darstellung Illustration		Darstellung Illustration	
Bauer-Best.Nr. Bauer Item No.	Bezeichnung Description	Bauer-Best.Nr. Bauer Item No.	Bezeichnung Description	Bauer-Best.Nr. Bauer Item No.	Bezeichnung Description
					 Bauer-ID: 437387
436946	Mutterteil Verbinder Female Coupling	436959	Vaterteil Verbinder Male Coupling	38202	(1x) O-Ring (340/6)
				436270	(1x) O-Ring (370/8)
				437252	(1x) Deckel   Top Cover
				35317	(1x) Zyl. Schraube Screw
				437386	(2x) Gliederband Wedge Chain
				437265	(1x) Buchse   Bushing

# Verfahrensausrüstung und Zubehör Methods Equipment and Accessories







**Ø 470**  
(DKS / CFA / FDP / SCM)



Darstellung Illustration		Darstellung Illustration		Darstellung Illustration	
Bauer-Best. Nr. Bauer Item No.	Bezeichnung Description	Bauer-Best. Nr. Bauer Item No.	Bezeichnung Description	Bauer-Best. Nr. Bauer Item No.	Bezeichnung Description
				Bauer-ID: 1170682 (DKS/CFA/FDP)	 SCM*
1168132	Mutterteil Verbinder Female Coupling	1144971	Vaterteil Verbinder Male Coupling	26776	(2x) O-Ring (132/5)
				38202	(2x) O-Ring (340/6)
				60339	(1x) O-Ring (380/10)
				803918	(1x) Deckel   Top Cover
				26616	(2x) Schraube   Screw
				437386	(2x) Gliederband Wedge Chain

\* Verbindungselement / Connecting Element SCM 1267484

## Sicherungsringe Verbindungselemente CFA/CCFA | Safety Rings Coupling Components

Darstellung Illustration	Bauer-Best.Nr. Bauer Item No.	Bezeichnung Description	Verwendung Usage
	1352223	Sicherungsring 254 Safety Ring	
	1355785	Sicherungsring 368 Safety Ring	
	1437434	Sicherungsring 470 Safety Ring	



## Schulungen und Seminare *Trainings and Seminars*

**Service** beinhaltet nicht nur Ersatzteile und Zubehör, sondern auch maßgeschneiderte Trainings für unsere Kunden und Partner.

### **Was bieten wir Ihnen?**

#### **Schulungen für Gerätefahrer und Mechaniker – für Einsteiger und Berufserfahrene**

Unsere Seminare orientieren sich am Kenntnisstand der Teilnehmer und können flexibel angepasst werden.

#### **Mehr Hintergrundwissen**

Unsere Trainer vermitteln fundiertes Grundlagenwissen über den Umgang mit Bauer-Geräten.

#### **Praxis an den Maschinen**

Sie erlernen die Bedienung, Service und Wartung der Bauer-Maschinen.

#### **IHRE Zufriedenheit ist UNSER Ansporn!**

Gerne entwickeln wir für Sie auch ein maßgeschneidertes Training.

Detaillierte Informationen über unsere Seminarinhalte, aktuelle Termine und vieles mehr finden Sie auf unserer Website oder nehmen Sie direkt Kontakt mit uns auf: [btc@bauer.de](mailto:btc@bauer.de)

<http://btc.bauer.de>  
[www.bauer-trainingcenter.de](http://www.bauer-trainingcenter.de)

*Service includes not only equipment and accessories, but also customized trainings for our customers and business partners.*

### **What do we provide?**

#### **Trainings for operators and technicians – for beginners and specialists**

*Our seminars are based on participants' current knowledge levels and can be flexibly adapted as required.*

#### **More background knowledge**

*The trainers provide sound basic know-how in the use of drilling rigs and the application of drilling and construction methods.*

#### **Practical experience on the machinery**

*You will learn how to operate, service and maintain Bauer equipment.*

#### **YOUR satisfaction is OUR motivation!**

*If our standard offer does not meet your training needs, we would be pleased to design "YOUR" training.*

*You can find detailed information on the contents of our seminars, current course offerings and much more on our website. Or contact us directly: [btc@bauer.de](mailto:btc@bauer.de)*













### **BAUER Training Center**

Erfolg durch Kompetenz und Qualität  
*Success through competence and quality*

# Verfahrensausrüstung und Zubehör

## Methods Equipment and Accessories

### Ersatzteile Single-Pass-Verfahren | Spare Parts Single Pass Methods









Ersatzteile DKS/SOB/Verdränger   Spare Parts DKS/CFA/FDP		
Darstellung Illustration	Bauer-Best.Nr. Bauer Item No.	Bezeichnung Description
	517375	Rotor kpl. NW 120 Rotor cpl.
	823686	Dichtungssatz für Rotor NW 120 Seal Kit for Rotor
	1102015	Messrohr kpl. NW 120 mit Sensor und Kabel (mit alten Modellen austauschbar; Regelelektronik muss entsprechend justiert werden) Measuring Tube cpl. with Sensor and Cable (Compatible to old Models; Control Device need to be adjusted accordingly)
	21639	O-Ring für Flansche vom Messrohr NW 120 O-Ring for Flanges of Measuring Tube
	264017	Gummi-Manschette NW 120 (passend f. Druckmitter 110505) Rubber Sleeve (fits Pressure Transducer 110505)
	517338	Betonwechselschieber kpl. NW 125/120 Concrete Valve cpl.
	515948	Dichtring f. Betonwechselschieber NW 125/120 (2 St. benötigt) Sealring for Concrete Valve NW 125/120 (2 pcs. required) (ab 2008   from 2008)
	119488	Dichtring f. Betonwechselschieber NW 125/120 (2 St. benötigt) Sealring for Concrete Valve NW 125/120 (2 pcs. required) (bis 2008   until 2008)
	416540	O-Ring f. Betonwechselschieber NW 125/120 (2 St. benötigt) O-Ring for Concrete Valve NW 125/120 (2 pcs. required)
	528544	Betondrucksensor 10 bar 1" mit M 12-Stecker Concrete Pressure Sensor 10 bar, 1" with M 12-Plug
	66401	Betondrucksensor mit Würfelstecker (für altes Messrohr-Modell) Pressure Transducer with Cubic Plug (for old Model of Measuring Tube)
	528585	Betonmengensensor 60 bar 1" mit M 12-Stecker Concrete Pressure Sensor 60 bar 1" with M 12-Plug

Passende Kabel für die Sensorik finden Sie auf den entsprechenden Seiten in diesem Katalog.  
Corresponding wiring cables can be found at the appropriate pages in this catalog.

# Verfahrensausrüstung und Zubehör

## Methods Equipment and Accessories





Ersatzteile Lost-Bit   Spare Parts Lost-Bit		
Darstellung Illustration	Bauer-Best.Nr. Bauer Item No.	Bezeichnung Description
	454978	Bohrspitze für Rohr-Innendurchmesser 325 mm (Seelenrohr 445) Drillbit for Inner Pipe Diameter (Hollow Stem Auger)
	448729	Bohrspitze für Rohr-Innendurchmesser 230 mm (Seelenrohr 368) Drillbit for Inner Pipe Diameter (Hollow Stem Auger)
	46902	Gleitleiste 200 x 60 x 25 mm, Metall Slide Rail, Metal
Ersatzteile Betonierausrüstung – Allgemein   Spare Parts Concrete Equipment – General		
Darstellung Illustration	Bauer-Best.Nr. Bauer Item No.	Bezeichnung Description
	31035	Rohr-/Schlauchkupplung Ø 100 mm, 4“ Pipe/Hose Coupling
	32350	Rohr-/Schlauchdichtung Ø 100 mm, 4“ Pipe/Hose Seal
	205980	Rohr-/Schlauchkupplung Ø 125 mm, 5 1/2“ Pipe/Hose Coupling
	205979	Rohr-/Schlauchdichtung Ø 125 mm, 5 1/2“ Pipe/Hose Seal
	22493	Sicherungssplint für Schlauchkupplungen Lock Clip for Hose Couplings
	400414	Ziehstrumpf Ø 150 - 180 mm Cable Grip Split
	400606	Schneckenengewindeschelle schwer Ø 146 - 168 mm Hose Clamp Heavy Duty

Viele weitere Betonierausrüstungsteile, wie auch Leitungen und Schläuche sind lagernd. Angebot auf Anfrage.  
Lots of further concrete equipment parts, as well as pipes and hoses are stock items. Offer on request.









# Verfahrensausrüstung und Zubehör

## Methods Equipment and Accessories

### Betonierzubehör DKS/SOB | Concrete accessories DKS/CFA

Verschlussdeckel für Betonaustrittsöffnungen am Anfänger DKS/SOB 125 mm Cover for Concrete Discharge Opening at the Starter DKS/SOB 125 mm		
Darstellung Illustration	Bauer-Best.Nr. Bauer Item No.	Bezeichnung Description
	1083187	Betonaustrittsdeckel, verstärkt, Einweg Concrete Cover, Reinforced, One-Way
	1144383	Betonaustrittsdeckel, Standard, Einweg Concrete Cover, Standard, One-Way
	477943	Betonaustrittsdeckel, Stahleinlage, Einweg Concrete Cover, Steel Insert, One-Way
	620815	Stahl, wiederverwendbar und mit Kette gesichert Steel, Reusable and Secured by a Chain

Viele weitere Betonierausüstungsteile, wie auch Leitungen und Schläuche sind lagernd. Angebot auf Anfrage.  
Lots of further concrete equipment parts, as well as pipes and hoses are stock items. Offer on request.

Reinigungshilfen Cleaning Aids		
Darstellung Illustration	Bauer-Best.Nr. Bauer Item No.	Bezeichnung Description
	1337657	Schwammrolch Ø 150x180 Sponge Pig
	1337684	Schwammzylinder Ø 140x150 Sponge Pig
	39739	Schwammkugel Ø 150, mittel Sponge Ball
	1337659	Schwammkugel Ø 150, fest Sponge Ball
	1337660	Schwammkugel Ø 150, weich Sponge Ball
	1337681	Schwammwürfel DN 125 Sponge Cube
	411022	Fangkorb SK 125-5 1/2 Trap Basket
	1337683	Reinigungsstutzen SK 125-5 1/2 Cleaning Nozzle
	1337686	Putzrolch aus Gummi Ø 125 Cleaning Pig, rubber-based

# Verfahrensausrüstung und Zubehör

## Methods Equipment and Accessories



### Ersatzteile Tiefenrüttler | Spare Parts Deep Vibrators

Darstellung Illustration	Position Position	Bauer-Best.Nr. Bauer Item No.	Bezeichnung Description
<b>TR 17 RDV</b>			
	A	260148	Verschleißschale kpl.   <a href="#">Wear Shell cpl.</a>
	B	70587	Gelenk kpl. Ø 298,5 L: 944   <a href="#">Joint cpl.</a>
<b>TR 17 RSV (≤ # 108)</b>			
	A	260148	Verschleißschale kpl.   <a href="#">Wear Shell cpl.</a>
	B	70587	Gelenk kpl. Ø 298,5 L: 944   <a href="#">Joint cpl.</a>
	C	927240	Materialendrohr s+b, DN: 200, L: 2000   <a href="#">Material End Tube</a>
	Doppelgelenk Materialrohr besteht aus:   <a href="#">Double Joint Material Tube consist of:</a>		
	D	514793	Doppelgelenk s+b, DN: 200   <a href="#">Double Joint</a>
		279117	Halbschale für Materialrohr DN: 200   <a href="#">Half Shell for Material Tube</a>
		35644	Zyl. Schraube mit I-6-kant, M 10 x 50   <a href="#">Hex. Socket Head Cap Screw</a>
		24574	Sicherungsscheibe 10 (8x)   <a href="#">Retaining Washer</a>
21122		Fluidtechnik-O-Ring 210 x 5   <a href="#">Fluid Power System-O-Ring</a>	
<b>TR 17 RSV-SA (≥ # 108)</b>			
	A	823343	Verschleißschale kpl.   <a href="#">Wear Shell cpl.</a>
	B	70587	Gelenk kpl. Ø 298,5 L: 944   <a href="#">Joint cpl.</a>
	C	823341	Materialendrohr s+b, DN: 200, L: 2017   <a href="#">Material End Tube</a>
	Doppelgelenk Materialrohr besteht aus:   <a href="#">Double Joint Material Tube consist of:</a>		
	D	514793	Doppelgelenk s+b, DN: 200   <a href="#">Double Joint</a>
		279117	Halbschale für Materialrohr DN: 200   <a href="#">Half Shell for Material Tube</a>
		35644	Zyl. Schraube mit I-6-kant, M 10 x 50   <a href="#">Hex. Socket Head Cap Screw</a>
		24574	Sicherungsscheibe 10 (8x)   <a href="#">Retaining Washer</a>
21122		Fluidtechnik-O-Ring 210 x 5   <a href="#">Fluid Power System-O-Ring</a>	
<b>TR 75 RDV</b>			
	A	104008	Verschleißschale kpl.   <a href="#">Wear Shell cpl.</a>
	B	520502	Gelenk kpl. Ø 406, L: 1200   <a href="#">Joint cpl.</a>
<b>TR 75 RSV</b>			
	A	514817	Verschleißschale kpl.   <a href="#">Wear Shell cpl.</a>
	B	520502	Gelenk kpl. Ø 406, L: 1200   <a href="#">Joint cpl.</a>
	Doppelgelenk Materialrohr besteht aus:   <a href="#">Double Joint Material Tube consist of:</a>		
	C	514793	Doppelgelenk s+b, DN: 200   <a href="#">Double Joint</a>
		279117	Halbschale für Materialrohr DN: 200   <a href="#">Half Shell for Material Tube</a>
		35644	Zyl. Schraube mit I-6-kant, M 10 x 50   <a href="#">Hex. Socket Head Cap Screw</a>
		24574	Sicherungsscheibe 10 (8x)   <a href="#">Retaining Washer</a>
21122	Fluidtechnik-O-Ring 210 x 5   <a href="#">Fluid Power System-O-Ring</a>		



GENERATOR BG 23H

NOTICE  
HAWKS



## Instandhaltung Maintenance



---

### Verschleißteile Drehbohrgeräte Wear Parts Rotary Drilling Rigs

- Gleitleisten Vorschubschlitten  
Wear Strips Sledge 214 - 215
- Verschleißteile Kellyausrüstung  
Wear Parts Kelly Equipment 216
- Mitnehmerschalen  
Driving Shells 217 - 220
- Seilwirbel  
Swivels 222 - 224



### Wartungsteile Maintenance Parts

- Filterelemente  
Filter Elements 226 - 232
- Ablassventile  
Drain Valves 233

# Verschleißteile Drehbohrgeräte

## Wear Parts Rotary Drilling Rigs

### Gleitleisten Vorschubschlitten | Slide Rails Sledge

Gleitleisten   Slide Rails			
Darstellung Illustration			
			-
Metall Metal	Kunststoff Synthetic Material	Kunststoff Synthetic Material	Länge x Breite x Höhe (mm) Length x Width x Height (mm)
Bauer-Best.Nr. Bauer Item No.			-
112712	442739	1274806	320 x 50 x 20
396331	482518	1364184	430 x 50 x 20
1369151	482519	1364186	460 x 60 x 25
193512	482520	1364223	660 x 60 x 25
647901	1105379	1364230	662 x 70 x 25

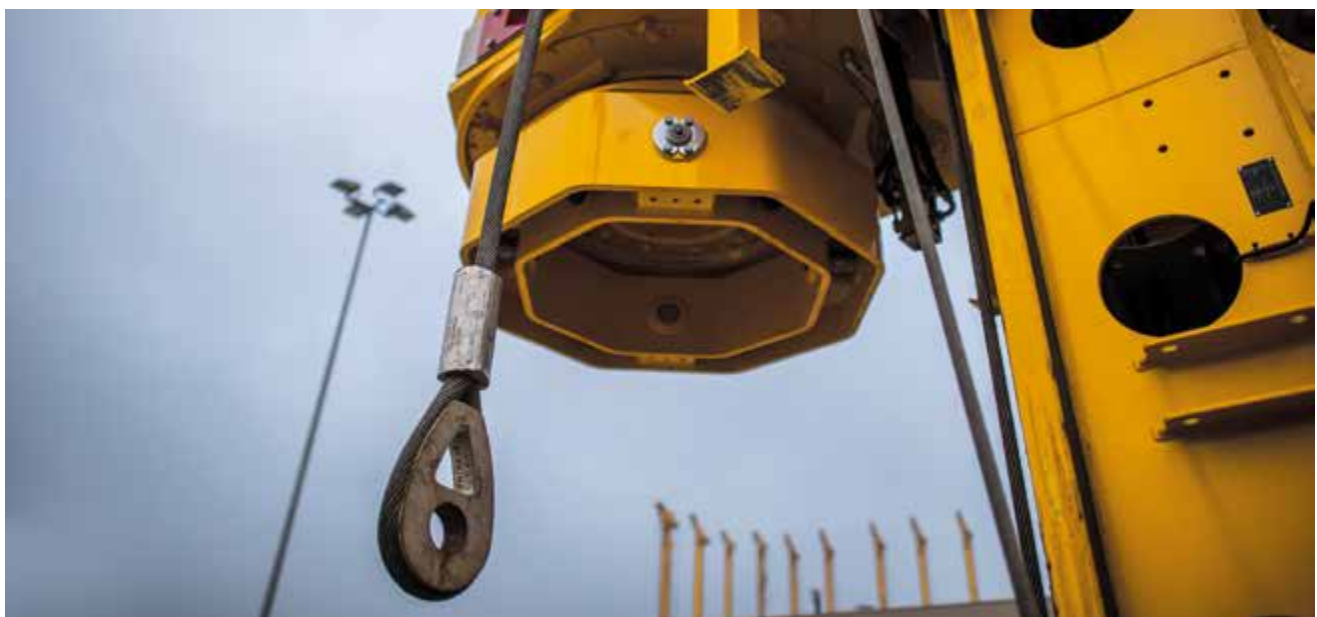

# Verschleißteile Drehbohrgeräte

## Wear Parts Rotary Drilling Rigs



Zubehör Gleitleisten   Additional Equipment Slide Rails					
Darstellung Illustration	Bauer-Best.Nr. Bauer Item No.	Bezeichnung Description	Länge (mm) Length (mm)	Breite (mm) Width (mm)	Höhe (mm) Height (mm)
	85654	Klemmstück Clamp	50	48	15
	367869		50	37,3	10
	124456		60	58	19
	467026		78	60	49
	472530		60	81,5	19
	647900		70	58	19





Darstellung Illustration	Bauer-Best.Nr. Bauer Item No.	Bezeichnung Description	Norm Standard
	45262	Zyl. Schraube mit I-6-kant Hexagon Socket Head Cap Screw	M 16 x 45
	35212		M 12 x 20
	45255		M 16 x 90
	262276		M 16 x 55
	35471		M 16 x 35
	36492		M 16 x 40
	388220		M 16 x 45
	35214		M 12 x 35

Darstellung Illustration	Bauer-Best.Nr. Bauer Item No.	Bezeichnung Description
	24575	Sicherungsscheibe 12 Retaining Washer
	24577	Sicherungsscheibe 16 Retaining Washer

# Verschleißteile Drehbohrgeräte

## Wear Parts Rotary Drilling Rigs

### Verschleißteile Kellyausrüstung | Wear Parts Kelly Equipment

Darstellung Illustration	Bauer-Best.Nr. Bauer Item No.	Bezeichnung Description	Verwendung Usage	Zusätzlich erforderlich Additional needed	
	95547	Endanschlagdämpfer 60 x 60 <a href="#">Limit Stop Damper</a>	Kellyausrüstung ≤ 419 <a href="#">Kelly Equipment</a>	1301748 Sechskantmutter PA-Klemmteil n. Form M 16 x 1,5 <a href="#">Hexagon Nut PA-Clamp Part I. Form</a> 1030964 Scheibe 17   <a href="#">Disc</a>	
	78483	Endanschlagdämpfer 70 x 140 <a href="#">Limit Stop Damper</a>	Kellyausrüstung ≥ 470 <a href="#">Kelly Equipment</a>	21403 Spannstift schwer 12 x 30 <a href="#">Spring Pin Heavy</a> 79081 Sechskantmutter PA-Klemmteil n. Form M 24 x 2   <a href="#">Hexagon Nut PA-Clamp Part I. Form</a>	
Darstellung Illustration	Bauer-Best.Nr. Bauer Item No.	Bezeichnung Description	Verwendung Usage	Zusatz-ausrüstung pro Stück * Additional Equipment per Unit *	
	735268	Dämpferbogen für: <a href="#">Bend for: 343/368</a>	Kellyausrüstung 343/368 <a href="#">Kelly Equipment</a>	87842 (2x) Sechskantmutter Metallklemmteil M 10   <a href="#">Hexagon Nut Metal Clamp Part</a> 201988 (2x) Flache Scheibe m. Fase M 10 <a href="#">Plain Washer with Chamfer</a>	
	715979	Dämpferbogen für: <a href="#">Bend for: 349/419</a>	Kellyausrüstung 394/419 <a href="#">Kelly Equipment</a>	87842 (2x) Sechskantmutter Metallklemmteil M 10   <a href="#">Hexagon Nut Metal Clamp Part</a> 201988 (2x) Flache Scheibe m. Fase M 10 <a href="#">Plain Washer with Chamfer</a>	
	735269	Dämpferbogen für: <a href="#">Bend for: 470/457</a>	Kellyausrüstung 470/457 <a href="#">Kelly Equipment</a>	87842 (3x) Sechskantmutter Metallklemmteil M 10   <a href="#">Hexagon Nut Metal Clamp Part</a> 201988 (3x) Flache Scheibe m. Fase M 10 <a href="#">Plain Washer with Chamfer</a>	
	979447	Verschleißring <a href="#">Ring</a>	Kellyausrüstung <a href="#">Kelly Equipment</a>	343	-
	979482			-	
	978893			-	
	977572			-	
	970242			-	



\* Im Lieferumfang der Dämpferbögen enthalten. | [Included in delivery scope of bend.](#)

# Verschleißteile Drehbohrgeräte Wear Parts Rotary Drilling Rigs



## Mitnehmerschalen | Driving Shells





Kellystange Ø 305   Kelly Bar			
Darstellung Illustration	Bauer-Best.Nr. Bauer Item No.	Beschreibung Description	Stückzahl   Quantity
			MKA 420*/305 MKA 360*/305 MKA 360*/305-SR
-	954113	Zusammenstellung – Mitnehmerschale Ø 305 bestehend aus: Compilation – Drive Shell consists of:	
	406304	Mitnehmerschale für Ø 305 Driving Shell	6x
	664792	Zyl. Schraube mit I-6-kant, M 12 x 60 Hexagon Socket Head Cap Screw	18x
	541381	Buchse Mitnehmerschale Ø 36, L: 17,9 Bushing Drive Shell	18x
	16586	Flache Scheibe M 12 Plain Washer	18x
	235563	Sechskantmutter PA-Klemmteil M 12 Hexagon Nut PA-Clamp Part	18x

# Verschleißteile Drehbohrgeräte

## Wear Parts Rotary Drilling Rigs

Kellystange Ø 343 (ausgenommen KA 400\*) | Kelly Bar (except KA 400\*)

Darstellung Illustration	Bauer-Best.Nr. Bauer Item No.	Beschreibung Description	Stückzahl   Quantity		
			KA 420*/343 XX (KDKs ohne Feder-Dämp- fung KDKs without spring damper)	KA 420*/343 XX (KDKs mit Feder- Dämpfung KDKs with spring damper)	KA 245/343 KA 500*/343 SR
-	956075	Zusammenstellung – Mitnehmerschale Ø 343 bestehend aus: Compilation – Drive Shell consists of:			
	96602	Mitnehmerschale für Ø 343 (L: 686 mm) Driving Shell	3x	3x	3x
	22875	Zyl. Schraube mit I-6-kant, M 12 x 50 Hexagon Socket Head Cap Screw	18x	15x	9x
	35214	Zyl. Schraube mit I-6-kant, M 12 x 35 Hexagon Socket Head Cap Screw	-	3x	9x
	79096	Buchse Mitnehmerschale Ø 36, L: 20 Bushing Drive Shell	18x	18x	18x
	16586	Flache Scheibe M 12 Plain Washer	18x	15x	9x
	235563	Sechskantmutter PA-Klemmteil M 12 Hexagon Nut PA-Clamp Part	18x	15x	9x

Kellystange Ø 343 KA 400 | Kelly Bar



Darstellung Illustration	Bauer-Best.Nr. Bauer Item No.	Beschreibung Description	Stückzahl   Quantity
			KA 400*/343
-	1147162	Zusammenstellung – Mitnehmerschale Ø 343 KA 400 bestehend aus: Bitte 3 Mal bestellen, um einen vollständigen Satz zu erhalten. Compilation – Drive Shell consists of: Please order 3 times for a complete set.	
	1082742	Mitnehmerschale für Ø 343 (L: 373 mm) KA 400 Drive Shell	1x
	60557	Schraubstopfen Screw Plug	2x
	402999	Zylinderstift 16 x 40 Cylindrical Pin	2x

# Verschleißteile Drehbohrgeräte



## Wear Parts Rotary Drilling Rigs



### Kellystange Ø 368 | Kelly Bar





Darstellung Illustration	Bauer-Best.Nr. Bauer Item No.	Beschreibung Description	Stückzahl   Quantity	
			KA 160/368 XX KA 420*/368 XX KA 500*/368 XX MKA 420*/368 XX (KDKs mit Feder-Dämpfung   KDKs with spring damper) KAES 420/368 XX	KAES 245/368 XX KAES 367/368 XX KAES 500*/368 XX KAES 800*/368 XX (KDKs ohne Feder-Dämpfung   KDKs without spring damper)
-	956077	Zusammenstellung – Mitnehmerschale Ø 368 bestehend aus: Compilation – Drive Shell consists of:		
	112315	Mitnehmerschale für Ø 368 Driving Shell	3x	3x
	219992	Zyl. Schraube mit I-6-kant, M 12 x 55 Hexagon Socket Head Cap Screw	15x	18x
	35214	Zyl. Schraube mit I-6-kant, M 12 x 35 Hexagon Socket Head Cap Screw	3x	-
	79096	Buchse Mitnehmerschale Ø 36, L: 20 Bushing Drive Shell	18x	18x
	16586	Flache Scheibe M 12 Plain Washer	-	18x
	235563	Sechskantmutter PA-Klemmteil M 12 Hexagon Nut PA-Clamp Part	15x	18x

### Kellystange Ø 394, 419 | Kelly Bar

Darstellung Illustration	Bauer-Best.Nr. Bauer Item No.	Beschreibung Description	Stückzahl   Quantity	
			KA 245/394 XX KA 500*/394 XX MKA 500*/394 XX	KA 500*/419 XX KA 670*/419 XX KA 800*/394 XX
-	956073	Zusammenstellung – Mitnehmerschale Ø 394 und Ø 419 bestehend aus: Compilation – Drive Shell consists of:		
	18648	Mitnehmerschale für Ø 394 u. Ø 419 Driving Shell	3x	3x
	219992	Zyl. Schraube mit I-6-kant, M 12 x 55 Hexagon Socket Head Cap Screw	18x	24x
	35214	Zyl. Schraube mit I-6-kant, M 12 x 35 Hexagon Socket Head Cap Screw	6x	-
	79096	Buchse Mitnehmerschale Ø 36, L: 20 Bushing Drive Shell	24x	24x
	16586	Flache Scheibe M 12 Plain Washer	18x	24x
	235563	Sechskantmutter PA-Klemmteil M 12 Hexagon Nut PA-Clamp Part	18x	24x

# Verschleißteile Drehbohrgeräte

## Wear Parts Rotary Drilling Rigs

Kellystange Ø 470   Kelly Bar			
Darstellung Illustration	Bauer-Best.Nr. Bauer Item No.	Beschreibung Description	Stückzahl   Quantity
			KA 670*/470 XX KA 800*/470 XX KA 960*/470 XX
-	956273	Zusammenstellung – Mitnehmerschale Ø 470 bestehend aus: Compilation – Drive Shell consists of:	
	201164	Mitnehmerschale für Ø 470 Driving Shell	3x
	26540	Zyl. Schraube mit I-6-kant, M 12 x 45 Hexagon Socket Head Cap Screw	24x
	79096	Buchse Mitnehmerschale Ø 36, L: 20 Bushing Drive Shell	24x
	16586	Flache Scheibe M 12 Plain Washer	24x
	235563	Sechskantmutter PA-Klemmteil M 12 Hexagon Nut PA-Clamp Part	24x
Kellystange Ø 559 720   Kelly Bar			
Darstellung Illustration	Bauer-Best.Nr. Bauer Item No.	Beschreibung Description	Stückzahl   Quantity
			KA 800*/559 XX KA 960*/559 XX
-	956278	Zusammenstellung – Mitnehmerschale Ø 559 bestehend aus: Compilation – Drive Shell consists of:	
	392717	Mitnehmerschale für Ø 559 Driving Shell	3x
	22875	Zyl. Schraube mit I-6-kant, M 12 x 50 Hexagon Socket Head Cap Screw	24x
	79096	Buchse Mitnehmerschale Ø 36, L: 20 Bushing Drive Shell	24x
	16586	Flache Scheibe M 12 Plain Washer	24x
	235563	Sechskantmutter PA-Klemmteil M 12 Hexagon Nut PA-Clamp Part	24x

\* Unterer Hohlwellendurchmesser  
\* Diameter lower hollow shaft

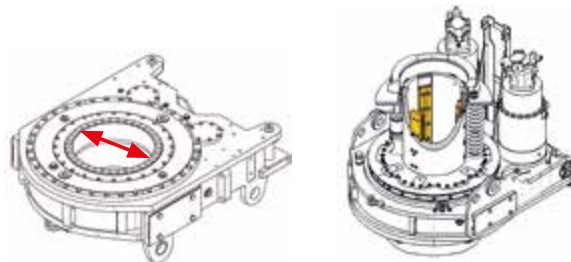



## Bauer Service-Pakete Bauer Maintenance Kits

Die Erfahrungswerte bestätigen, dass Lebensdauer und Reparaturkosten Ihres Gerätes grundlegend von Pflege und Einhaltung der Serviceintervalle abhängig sind.

Aus diesem Grund bietet die BAUER Maschinen GmbH die Option, individuelle Service-Pakete für die Bauer-Geräte unserer Kunden zu erstellen.

Diese Pakete enthalten alle Standard-Komponenten zur Durchführung der erforderlichen Services, die dann ohne weitere Bestellungen (mit Ausnahme der Öle) durchgeführt werden können. Bei Neugerätee-lieferungen können die Pakete frachtfrei mit dem Gerät geliefert werden.

Bei Interesse an einem BAUER Service-Paket benötigen wir den betreffenden Maschinentyp inklusive der Seriennummer und Betriebsstunden. Schicken Sie uns diese Informationen gerne an [BMA-Parts-and-Service@bauer.de](mailto:BMA-Parts-and-Service@bauer.de). Danach erhalten Sie ein unverbindliches Angebot von unseren Disponenten.

*Regular servicing and maintenance, at the recommended maintenance intervals, will not only help to increase the equipment's operational life, but may help in mitigating costly repairs in future years.*

*BAUER Maschinen GmbH now offers individual maintenance packages for all rigs of our customers. The packages contain all standard components, excluding oils, for the specific service.*

*If you expect a new rig delivery, it is possible to send the maintenance package together with the rig – without additional transport costs.*

*If we caught your interest in our Bauer Maintenance Packages just send us machine type, serial number and the operating hours of your rig to [BMA-Parts-and-Service@bauer.de](mailto:BMA-Parts-and-Service@bauer.de). Afterwards we will send you a non-binding offer.*

Jetzt auch in myBAUER unter „Meine Flotte“ bestellbar.  
[www.my.bauer.de](http://www.my.bauer.de)

# Verschleißteile Drehbohrgeräte

## Wear Parts Rotary Drilling Rigs

### Seilwirbel | Swivels

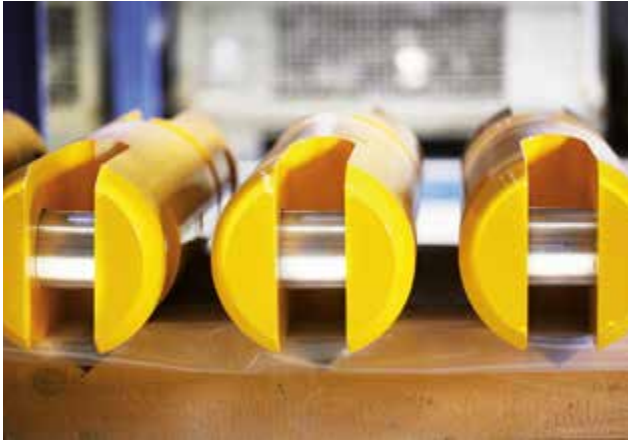

		Seilwirbel Ø 90 Swivel	Seilwirbel Ø 160 Swivel	Seilwirbel Ø 160 Swivel	Seilwirbel Ø 160 Swivel
	Bauer-Best.Nr. Seilwirbel kpl. Bauer Item No. Swivel cpl.	39602	218318	625515	207258
	Typ   Type	10 to	17 to	30 to	30 to
	Bolzen   Pin	24/24	50/50	60/60	60/50
Bauer-Best.Nr. Bauer Item No.	Bezeichnung Description				
731634	Innensechskantschraube M 24 x 74   <a href="#">Socket-Head Screw</a>	2x	-	-	-
23340	Dubo-Sicherung 24 mm   <a href="#">Dubo-Lock Washer</a>	2x	-	-	-
20871	Kegelschmiernippel M 8 x 1   <a href="#">Grease Nipple</a>	1x	-	-	-
44121	Bolzen Ø 50, L: 105   <a href="#">Pin</a>	-	2x	-	-
44664	Sechskantschraube M 16 x 120   <a href="#">Hexagon Screw</a>	-	2x	-	-
20254	Federring 16 mm   <a href="#">Spring Ring</a>	-	2x	-	-
44120	Scheibe ID 18, OD 59,5   <a href="#">Disc</a>	-	2x	-	-
207259	Bolzen Ø 50, L: 112   <a href="#">Pin</a>	-	-	-	1x
71095	Bolzen Ø 59, L: 112   <a href="#">Pin</a>	-	-	2x	1x
32173	Einspannbuchse ID 50, OD 60, L: 35   <a href="#">Tension Bushing</a>	-	-	-	1x
25319	Einspannbuchse ID 50, OD 60, L: 32   <a href="#">Tension Bushing</a>	-	-	-	1x
25001	Sechskantschraube M 16 x 130   <a href="#">Hexagon Screw</a>	-	-	2x	2x
71096	Scheibe ID 18, OD 72   <a href="#">Disc</a>	-	-	2x	2x
24577	Sicherungsscheibe 16 mm   <a href="#">Lock Washer</a>	-	-	2x	2x
30454	Kegelschmiernippel M 10 x 1   <a href="#">Grease Nipple</a>	-	1x	1x	1x

# Verschleißteile Drehbohrgeräte





## Wear Parts Rotary Drilling Rigs



		Seilwirbel Ø 195 Swivel	Seilwirbel Ø 195 Swivel	Seilwirbel Ø 216 Swivel	Seilwirbel Ø 235 Swivel	Seilwirbel Ø 235 Swivel
	Bauer-Best.Nr. Seilwirbel kpl. Bauer Item No. Swivel cpl.	203492	1290344	908643 1130587	392251 1402600	392252 1402631
	Typ   Type	30 to	40 to	50 to	60 to	60 to
	Bolzen   Pin	80/60	80/80	80/80	100/100	100/80
Bauer-Best.Nr. Bauer Item No.	Bezeichnung Description					
76921	Bolzen Ø 59, L: 132   Pin	1x	-	-	-	-
76922	Distanzbuchse 60   Spacer Sleeve	2x	-	-	-	-
85012	Bolzen Ø 79, L: 132   Pin	1x	2x	-	-	-
85013	Scheibe 18   Disc	2x	2x	-	-	-
833225	Bolzen 79   Pin	-	-	2x	-	-
30454	Kegelschmiernippel M 10 x 1   Grease Nipple	1x	1x	1x	1x	1x
206234	Schmiernippelkappe   Grease Nipple Cap	1x	1x	1x	1x	1x
763838	Scheibe   Disc	-	-	2x	-	-
365133	Ring ID 80, OD 160   Ring	-	2x	-	1x	1x
392248	Scheibe ID 17,5, OD 115   Disc	-	-	2x	2x	2x
392245	Bolzen Ø 79, L: 177   Pin	-	-	2x	-	1x
392244	Reduzierbuchse ID 80, OD 100   Reducing Bushing	-	-	4x	-	2x
250565	Sechskantschraube M 16 x 190   Hexagon Screw	-	-	2x	2x	2x
392249	Bolzen Ø 99, L: 177   Pin	-	-	-	2x	1x
27528	Sechskantschraube M 16 x 150   Hexagon Screw	2x	2x	-	-	-
24577	Sicherungsscheibe 16 mm   Lock Washer	2x	2x	2x	2x	2x
277401	Sechskantschraube M 16 x 180   Hexagon Screw	-	-	2x	-	-
851013	Ring   Ring	-	-	2x	-	-

# Verschleißteile Drehbohrgeräte

## Wear Parts Rotary Drilling Rigs

Darstellung Illustration	Bauer-Best.Nr. Bauer Item No.	Bezeichnung Description	Beschreibung Explanation
	361906	Wirbel, isoliert 12,5 to Swivel Hook, Insulated	<p>Isolierter Wirbel für spannungsfreie Schweißarbeiten am Hilfsseil</p> <p>Güteklasse 8 kugelgelagert unter Last drehbar isoliert bis max. 1000 V staubgeschützt und wasserdicht geringe Bauhöhe kleines Eigengewicht Sicherheitsfaktor 4</p> <p>Insulated Swivel Hook for welding purposes e. g. parts attached to the auxiliary rope</p> <p>Quality Grade 8 Ball bearing mounted Rotatable under load Insulated until max. 1000 V Dust- and waterproof Low overall height Low deadweight Safety factor 4</p>
	351063	Wirbel, isoliert ohne Haken, 12,5 to Swivel Insulated without Hook	<p>Für Ketten 18/20 mm, mit 2 Kupplungsgliedern</p> <p>For nominal chain thickness 18/20 mm, with 2 coupling links</p>
	351951	Wirbel mit Kettengehänge kpl. Swivel Chain Suspension cpl.	<p>Wirbel, isoliert, ohne Haken 12,5 to</p> <p>Swivel Insulated, without Hook</p>
	1124518	Wirbellasthaken 6,5 to Swivel Hook	<p>Ausführung mit Lager, unter Last drehbar, für Ketten-Nennstärke 13 mm</p> <p>Version with bearing, rotatable under load, for nominal chain thickness 13 mm</p>
	84273	Aufhängeglied Ø 36 – 260 x 140 Suspension Link	<p>Nennstärke Ø 36 mm Innenlänge 260 mm Innenbreite 140 mm</p> <p>Nominal Thickness Ø 36 mm Inside Length 260 mm Interior Width 140 mm</p>
	700941	Ankerschäkel 8,5 to Shackle	-
	701033	Haken mit Falle 8 to Hook with Lock	<p>Für Ketten-Nennstärke 13 mm</p> <p>For nominal chain thickness</p>





## Fertigstahlseile

### Wire Ropes

- Wir können Ihnen Fertigstahlseile in vielfältiger Ausführung anbieten: Viele Durchmesser in gewünschter Länge, in verschiedenen Schlagarten und -richtungen mit den geforderten Endverbindungen in allen im Tiefbau gängigen Zugfestigkeiten.
- Die Seilauswahl unserer Bauer-Geräte beruht auf den Ergebnissen jahrelanger Erfahrung und ständiger Weiterentwicklung. Jedes Seil wird von uns getestet, um festzustellen, welcher Seiltyp für die jeweilige Anwendung optimal ist.
- Senden Sie Ihre Anfrage mit der Seilspezifikation einfach an [BMA-Parts-and-Service@bauer.de](mailto:BMA-Parts-and-Service@bauer.de) und wir unterbreiten Ihnen gerne ein entsprechendes Angebot.
- *We can offer wire ropes in diverse specifications: many diameters in desired lengths, various lay types and directions, with required joints and all in civil engineering established tensile strengths.*
- *The rope selection of Bauer rigs is based on the results of long lasting experience and permanent developments.*
- *Each rope is tested to identify the ideal rope for each specific application.*
- *Just send an enquiry with your specification to [BMA-Parts-and-Service@bauer.de](mailto:BMA-Parts-and-Service@bauer.de) and we will send an appropriate offer.*

# Wartungsteile Maintenance Parts

## Filterelemente | Filter Elements













Luftfilter   Air Filter				
Darstellung Illustration	Bauer-Best.Nr. Bauer Item No.	Beschreibung / Verwendung Description / Application	Größe (mm) Size (mm)	Ø Filter (mm) Ø Filter (mm)
	416307	Luftfilter außen Air Filter Outside	600	300
	416308	Luftfilter innen Air Filter Inside	580	195
	382688	Luftfilter außen Air Filter Outside	600	300
	382693	Luftfilter innen Air Filter Inside	575	195
	368668	Luftfilter Hauptfilterelement Air Filter Primary Element	530	280
	368667	Luftfilter Sicherheitselement Air Filter Safety Element	500	155
	379883	Luftfilter außen Air Filter Outside	630	330
	379884	Luftfilter innen Air Filter Inside	615	210
	378734	Luftfilterpatrone Air Filter Cartridge	190	90
	512034	Luftfilterelement sekundär Air Filter Element Secondary	230	625
	512033	Luftfilterelement primär Air Filter Primary Element	355	630
	385343	Raumluftfilter Kabine Air Filter Cabin	345 x 195 x 20	
	460833	Raumluftfilter Kabine Air Filter Cabin	405 x 185 x 35	

Auf Anfrage stellen wir Ihnen kostenlos die Original-Filterliste Ihres Bauer-Gerätes zusammen! Kontaktieren Sie uns unter [BMA-Parts-and-Service@bauer.de](mailto:BMA-Parts-and-Service@bauer.de)  
 Die Original-Filterliste Ihres Bauer-Gerätes finden Sie in myBAUER unter „**Meine Flotte**“.  
 If required, we can provide a list of the original filters supplied with your particular rig. Please contact [BMA-Parts-and-Service@bauer.de](mailto:BMA-Parts-and-Service@bauer.de)  
 You can find the original filter list of your Bauer machine on myBAUER under “**my fleet**”.

# Wartungsteile

## Maintenance Parts









Darstellung Illustration	Bauer-Best.Nr. Bauer Item No.	Beschreibung / Verwendung Description / Application	Größe (mm) Size (mm)
	723530	Raumluftfilter Kabine <a href="#">Air Filter Cabin</a>	200 x 120 x 23
	1145529	Raumluftfilter Kabine <a href="#">Air Filter Cabin</a>	328 x 130 x 30
	532392	Luftfilterelement sekundär <a href="#">Air Filter Element Secondary</a>	190 x 315 x 40
	532393	Luftfilterelement primär <a href="#">Air Filter Primary Element</a>	210 x 335 x 185
	782294	Luftfilterelement primär <a href="#">Air Filter Primary Element</a>	400 x 425 x 150
	782295	Luftfilterelement sekundär <a href="#">Air Filter Element Secondary</a>	410 x 143 x 52
	727633	Luftfilterelement sekundär <a href="#">Air Filter Element Secondary</a>	365 x 240 x 45
	727634	Luftfilter Sicherheitselement <a href="#">Air Filter Safety Element</a>	400 x 260 x 335
	968197	Luftfilter primär <a href="#">Primary Air Filter</a>	383 x 254 x 236
	1088369	Luftfilterelement primär <a href="#">Air Filter Primary Element</a>	450 x 260 x 340
	1088370	Luftfilterelement sekundär <a href="#">Air Filter Element Secondary</a>	425 x 240 x 40
	1094101	Kurbelgehäuseentlüftungsfilter <a href="#">Crankcase Ventilation Filter</a>	-
	55921	Matte <a href="#">Mat</a>	173 x 173 x 17 ggf. zuschneiden   <a href="#">cut to size</a>
	1031255	Filtermatte <a href="#">Filter Mat</a>	185 x 200 x 11

Auf Anfrage stellen wir Ihnen kostenlos die Original-Filterliste Ihres Bauer-Gerätes zusammen! Kontaktieren Sie uns unter [BMA-Parts-and-Service@bauer.de](mailto:BMA-Parts-and-Service@bauer.de)  
If required, we can provide a list of the original filters supplied with your particular rig. Please contact [BMA-Parts-and-Service@bauer.de](mailto:BMA-Parts-and-Service@bauer.de)

# Wartungsteile

## Maintenance Parts

Hydraulikfilter   Hydraulic Filter				
Darstellung Illustration	Bauer-Best.Nr. Bauer Item No.	Beschreibung / Verwendung Description / Application	Größe (mm) Size (mm)	Ø Filter (mm) Ø Filter (mm)
	261634	Druckfilter Pressure Filter	90	45
	79060	Druckfilter Pressure Filter	155	47
	19239	Druckfilter Pressure Filter	155	47
	237101	Leckölfilter Leaking Oil Filter	310	85
	880883	Rücklauffilter Reverse Flow Filter	415	115
	393051	Druckfilter Pressure Filter	115	70
	616105	Hydraulikfilter Hydraulic Filter	147	95
	63644	Hydraulikfilterelement Hydraulic Filter Element	220	85
	643610	Hydraulikfilterelement 3 µm Hydraulic Filter Element	330	90,5
	365334	Hydraulikfilterelement 5 µm Hydraulic Filter Element	85	45
	367505	Hydraulikfilterelement 10 µm Hydraulic Filter Element	94	35
	393080	Hydraulikfilterelement 10 µm Hydraulic Filter Element	85	47
	71572	Hydraulikfilterelement 10 µm Hydraulic Filter Element	163	90
	213219	Hydraulikfilterelement 20 µm Hydraulic Filter Element	203	73
	46580	Hydraulikfilterelement 20 µm Hydraulic Filter Element	84,5	47
	650480	Hydraulikfilterelement 20 µm Hydraulic Filter Element	265	95
	517242	Hydraulikfilterelement 25 µm Hydraulic Filter Element	173,5	69

Auf Anfrage stellen wir Ihnen kostenlos die Original-Filterliste Ihres Bauer-Gerätes zusammen! Kontaktieren Sie uns unter [BMA-Parts-and-Service@bauer.de](mailto:BMA-Parts-and-Service@bauer.de)  
If required, we can provide a list of the original filters supplied with your particular rig. Please contact [BMA-Parts-and-Service@bauer.de](mailto:BMA-Parts-and-Service@bauer.de)

# Wartungsteile









## Maintenance Parts



Darstellung Illustration	Bauer-Best.Nr. Bauer Item No.	Beschreibung / Verwendung Description / Application	Größe (mm) Size (mm)	Ø Filter (mm) Ø Filter (mm)
	76687	Hydraulikfilterelement 25 µm Hydraulic Filter Element	94	35
	1025264	Hydraulikfilterelement 40 µm Hydraulic Filter Element	-	-
	360029	Rücklauffilter Reverse Flow Filter	195	95
	225609	Rücklauffilter Reverse Flow Filter	635	100
	417908	Rücklauffilter Reverse Flow Filter	355	150
	466032	Saugfilter Suction Filter	320	160
	372283	Vorsteuerfilter Pilot Pressure Filter	115	60
	54937	Vorsteuerfilter Pilot Pressure Filter	85	45
	417909	Vorsteuerfilter Pilot Pressure Filter	90	40
	398554	Leckölfilter Leaking Oil Filter	165	90
	430314	Saugfilter Suction Filter	200	205
	17204	Vorsteuerfilter Pilot Pressure Filter	155	45
	711197	Rücklauffilter Reverse Flow Filter	455	150
	723533	Vorsteuerfilter Pilot Pressure Filter	115	55
	731325	Leckölfilter Leaking Oil Filter	455	150

Auf Anfrage stellen wir Ihnen kostenlos die Original-Filterliste Ihres Bauer-Gerätes zusammen! Kontaktieren Sie uns unter [BMA-Parts-and-Service@bauer.de](mailto:BMA-Parts-and-Service@bauer.de)  
If required, we can provide a list of the original filters supplied with your particular rig. Please contact [BMA-Parts-and-Service@bauer.de](mailto:BMA-Parts-and-Service@bauer.de)

# Wartungsteile Maintenance Parts











Kraftstofffilter   Fuel Filter				
Darstellung Illustration	Bauer-Best.Nr. Bauer Item No.	Beschreibung / Verwendung Description / Application	Größe (mm) Size (mm)	Ø Filter (mm) Ø Filter (mm)
	388156	Kraftstofffilter 1R-0762 Fuel Filter	270	94
	413554	Wasserabscheider 326-1643 Liquid Separator	240	110
	656721	Schauglas Inspection Glass	-	-
	378780	Wasserabscheider 133-5673 Liquid Separator	220	110
	736698	Schauglas Inspection Glass	-	-
	276697	Kraftstofffilter 1R-0749 Fuel Filter	270	90
	266489	Kraftstofffilter 1R-0751 Fuel Filter	180	85
	723529	Dieselfilter 11 NA-72011 Diesel Filter	155	110
	430350	Dieselfilter 11 LB-70020 Diesel Filter	180	95
	731322	Kraftstoffvorfilter 11 LB-70020 Fuel Fuel Filter	175	90
	430351	Dieselfilter 3973233-FS 19732 Diesel Filter	165	95
	464450	Dieselfilter FF 5485 Diesel Filter	195	90

Auf Anfrage stellen wir Ihnen kostenlos die Original-Filterliste Ihres Bauer-Gerätes zusammen! Kontaktieren Sie uns unter [BMA-Parts-and-Service@bauer.de](mailto:BMA-Parts-and-Service@bauer.de)  
If required, we can provide a list of the original filters supplied with your particular rig. Please contact [BMA-Parts-and-Service@bauer.de](mailto:BMA-Parts-and-Service@bauer.de)

# Wartungsteile

## Maintenance Parts















Darstellung Illustration	Bauer-Best.Nr. Bauer Item No.	Beschreibung / Verwendung Description / Application	Größe (mm) Size (mm)	Ø Filter (mm) Ø Filter (mm)
	417905	Wasserabscheider 11 E1-70310 Liquid Separator	105	95
	686725	Dieselfilter 31ND-01450 Fuel Filter	175	135
	880883	Dieselfilter FF 63009 Fuel Filter	182	102
	23648	Kraftstofffilter H101WK Fuel Filter	-	-
	904304	Kraftstofffilter 360-8960 Fuel Filter	155	81,7
	904290	Wasserabscheider 479-4131 Water Separator	226,5	82
	949462	Kraftstoffvorfilter 531-9680 Fuel Pre Filter	229	120
	984302	Kraftstofffilter 530-3743 Fuel Filter	180	101
	1131358	Kraftstofffilter 525-6205 Fuel Filter	78	55
	1311374	Kraftstofffilter 209-98367 Fuel Filter	142	93
	1311375	Wasserabscheider 224-80372 Water Separator	263	108

Auf Anfrage stellen wir Ihnen kostenlos die Original-Filterliste Ihres Bauer-Gerätes zusammen! Kontaktieren Sie uns unter [BMA-Parts-and-Service@bauer.de](mailto:BMA-Parts-and-Service@bauer.de)  
If required, we can provide a list of the original filters supplied with your particular rig. Please contact [BMA-Parts-and-Service@bauer.de](mailto:BMA-Parts-and-Service@bauer.de)

# Wartungsteile

## Maintenance Parts

Motorölfilter   Engine Oil Filter				
Darstellung Illustration	Bauer-Best.Nr. Bauer Item No.	Beschreibung / Verwendung Description / Application	Größe (mm) Size (mm)	Ø Filter (mm) Ø Filter (mm)
	464451	Motorölfilter 3937736 – LF 3970 Engine Oil Filter	180	90
	430352	Motorölfilter 3401544 – LF 9009 Engine Oil Filter	300	120
	237748	Motorölfilter 1R-0716 Engine Oil Filter	310	135
	406665	Motorölfilter 1R-1807 Engine Oil Filter	260	110
	402751	Motorölfilter 1R-1808 Engine Oil Filter	320	135
	791139	Motorölfilter 249-2347 Engine Oil Filter	225	140
	731324	Motorölfilter 11NA-70110 Engine Oil Filter	300	120
	1120732	Motorölfilter 462-1171 Engine Oil Filter	200	93
	1311372	Motorölfilter 230-75366 Engine Oil Filter	188	108
	1311373	Motorölfilter 230-75367 Engine Oil Filter	188	108
Be- und EntlüftungsfILTER   Breather Filter Tank				
Darstellung Illustration	Bauer-Best.Nr. Bauer Item No.	Beschreibung / Verwendung Description / Application	Länge (mm) Length (mm)	Ø Filter (mm) Ø Filter (mm)
	791140	Kurbelraum Entlüftungs-Filterelement Crankcase Ventilation Filter	325	185
	862146	Kurbelraum Entlüftungs-Filterelement Crankcase Ventilation Filter	290	68
	357596	Hydraulik Tank - BelüftungsfILTER Breather Filter	60	83
	435281	Tankbelüftung 31EH-00480 Breather Filter	32	70
	904302	EntlüftungsfILTER 339-1048 Breather Filter	155	104

Auf Anfrage stellen wir Ihnen kostenlos die Original-Filterliste Ihres Bauer-Gerätes zusammen! Kontaktieren Sie uns unter [BMA-Parts-and-Service@bauer.de](mailto:BMA-Parts-and-Service@bauer.de)  
If required, we can provide a list of the original filters supplied with your particular rig. Please contact [BMA-Parts-and-Service@bauer.de](mailto:BMA-Parts-and-Service@bauer.de)



# Wartungsteile Maintenance Parts

## Ablassventile | Drain Valves

Ölablassventil   Drain Plug					
Darstellung Illustration	Bauer-Best.Nr. Bauer Item No.	Bezeichnung Description	Ventilmaß Valve Dimensions	Anschlussmaß Connection Dimensions	Material Material
	360171	Ölablassventil Drain Plug	M 18 x 1,5	M 22 x 1,5	Stahl Steel
	395483	Ölablassventil Drain Plug	M 18 x 1,5	M 26 x 1,5	Stahl Steel
	49237	Ölablassventil Drain Plug	M 22 x 1,5	M 26 x 1,5	Stahl Steel
	415161	Ölablassventil Drain Plug	M 26 x 1,5	M 26 x 1,5	Messing Brass
	415160	Ölablassventil Drain Plug	G = R 3/4"	M 26 x 1,5	Stahl Steel
	489270	Ölablassventil Drain Plug	G = R 1/2"	M 26 x 1,5	Stahl Steel
	261433	Ölablassventil Drain Plug	3/4" UNF	M 26 x 1,5	Stahl Steel
	49236	Ölablassventil Drain Plug	M 30 x 1,5	M 26 x 1,5	Messing Brass
	275120	Ölablassventil Drain Plug	G = R 1"	M 26 x 1,5	Messing Brass
	489269	Ölablassventil Drain Plug	1 1/8" UNF	M 26 x 1,5	Messing Brass
	669447	Ölablassventil Drain Plug	1" NPT	M 26 x 1,5	Messing Brass

Anschlussstück   Pipe Fittings		
Darstellung Illustration	Bauer-Best.Nr. Bauer Item No.	Bezeichnung Description
	360172	Ölablassschlauch 90°, M 22 x 1,5 L: 0,25 m   Oil Drain Adapter Hose
	428673	Ölablassschlauch M 22 x 1,5 L: 0,5 m   Oil Drain Adapter Hose
	213392	Ölablassschlauch M 26 x 1,5 L: 1 m   Oil Drain Adapter Hose
	50500	Ölablassschlauch 90°, M 26 x 1,5 L: 0,25 m   Oil Drain Adapter Hose

Zubehör   Accessories	
Bauer-Best.Nr. Bauer Item No.	Bezeichnung Description
360173	PVC-Schlauch (Meterware), 14 x 19 mm   PVC-Hose (Cut Goods)
50499	Schlauchtülle für Ölablassschlauch   Fitting for Oil Drain Hose



## Elektrik Electrics















---

<b>Ersatzteile Elektro/Elektronik</b> <b>Spare Parts Electrics/Electronics</b>	<b>236 - 267</b>
· Bedienelemente Cabin Controls	236 - 237
· Schalter und Zubehör Switches and Accessories	238 - 240
· Sensoren Sensors	241
· Batterieanschlüsse und Tiefenmessung Battery Connectors and Depth Measurement	242
· Endschalter Limit Switches	244 - 248
· Leuchten und Zubehör Lamps and Accessories	250
· Nachrüstset Rückfahrkamera Retrofit Kit Rear View Camera	251
· Relais Relays	252
· Sicherungsautomaten Circuit Breakers	253
· Elektro-Steckverbinder Harting Electric Connections Harting	254 - 259
· Kabel Cables	261 - 265
· Allgemeine Elektrikteile und Werkzeuge General Electric Parts and Tools	266 - 267

# Ersatzteile Elektro/Elektronik

## Spare Parts Electrics/Electronics











### Bedienelemente | Cabin Controls

Darstellung Illustration	Bauer-Best.Nr. Bauer Item No.	Bezeichnung Description	Darstellung Illustration	Bauer-Best.Nr. Bauer Item No.	Bezeichnung Description
	1078719	Joystickgriff links mit CAN-Bus (für Oberwagen BT50D)  Joystick Handle Leftside with CAN-Bus (for BT50D-Base)		1078720	Joystickgriff rechts mit CAN-Bus (für Oberwagen BT50D)  Joystick Handle Rightside with CAN-Bus (for BT50D-Base)
	1067332	Joystick links mit CAN-Bus (Ü)  Joystick Left with CAN-Bus (R)		1067333	Joystick rechts mit CAN-Bus (Ü)  Joystick Right with CAN-Bus (R)
	795903	CAN-Open Doppel- T-Joystick rechts  CAN-Open Double- T-Joystick Right		508887	CAN Doppel- T-Joystick rechts  CAN-Double-T-Joy- stick Right
	365902	Elektronisches Fußpedal links mit Anschlussbuchse 9-polig  Electric Foot Pedal Left with Connector 9-pole		366969	Elektronisches Fußpedal rechts mit Anschlussbuchse 9-polig  Electric Foot Pedal Right with Connector 9-pole
	861759	Fußpedal links mit Kabel in/out  Foot Pedal Left with Cable in/out		861760	Fußpedal rechts mit Kabel in/out  Foot Pedal Right with Cable in/out
	387783	Zünd-/Startschalter mit 2 Schlüsseln  Ignition Starter Switch with 2 Keys		380577	Armlehnschalter  Armrest Switch



# Ersatzteile Elektro/Elektronik











## Spare Parts Electrics/Electronics











Darstellung Illustration	Bauer-Best.Nr. Bauer Item No.	Bezeichnung Description
	249948	Joystickgriff mit Mikro-Schaltern und Gummitastern (für Sennebogen BS60/70/80/100) Joystick Handle, c/w Micro Switches and Rubber Buttons (for Sennebogen BS60/70/80/100 )
	393333	Gummitaster-Set für Joystickgriff (Bauer-ID 249948) Rubber Button Set for Joystick Handle (Bauer-ID 249948)
	9687	Joystickgriff mit Tastknöpfen O&K Joystick Handle with Buttons O&K
	60451	Joystickgriff Schalter O&K (2 St. pro Joystickgriff Bauer-ID 9687 benötigt) Joystick Handle Switch O&K (2 pcs. per Joystick Handle Bauer-ID 9687 Required)
	285366	Fuß-Bremsventil Foot Break Valve
	385316	Hydraulisches Fußpedal (für Fahrwerk BT-Oberwagen) Hydraulic Foot Pedal (for Crawler BT-Base)
	933499	Stößelbausatz – NBR Dichtung Push Rod Construction Set - NBR Sealing
	1107967	Fußtaster Foot Switch
	710582	Schalterstütze Switch Support
	65944	Fußpedalschalter Freilauf Foot Pedal Switch for Free-Wheel
	1277225	Bodenelement Floor Element

# Ersatzteile Elektro/Elektronik

## Spare Parts Electrics/Electronics

### Schalter und Zubehör | Switches and Accessories











Darstellung Illustration	Bauer-Best.Nr. Bauer Item No.
	Bezeichnung Description
	384897
	Knebelgriff 2 Stellungen, rastend T-Handle 2 Positions, Adjustable
	384899
	Knebelgriff 3 Stellungen, rastend T-Handle 3 Positions, Adjustable
	385836
	Schlüsselschalter 3 Stellungen, rastend Key Switch 3 Positions, Adjustable
	612867
	Codierteilsatz Subset Coded
	371762
	Drucktaste flach, tastend Push Button Flat, Tentative
	387402
	Pilzdrucktaste tastend Mushroom Push Button Tentative
	384666
	Leuchtdrucktaste tastend Illuminated Push Button Tentative
	384310
	Leuchtdrucktaste tastend Illuminated Push Button Tentative
	392583
	Leuchtmeldervorsatz Indicating Lamp Bezel
	384669
	Leuchtmeldervorsatz Indicating Lamp Bezel
	384311
	LED-Element Front, weiß, 12 - 30 V LED-Element Front, White









Darstellung Illustration	Bauer-Best.Nr. Bauer Item No.
	Bezeichnung Description
	389625
	Knebelgriff 2 Stellungen, tastend T-Handle 2 Positions, Adjustable
	385833
	Schlüsselschalter 2 Stellungen, rastend Key Switch 2 Positions, Adjustable
	428121
	Schlüsselschalter 3 Stellungen, tastend Key Switch 3 Positions, Tentative
	385835
	Ersatzschlüssel Spare Key
	371763
	Drucktaste flach, tastend Push Button Flat, Tentative
	387401
	Pilzdrucktaste tastend Mushroom Push Button Tentative
	387415
	Leuchtdrucktaste tastend Illuminated Push Button Tentative
	396949
	Leuchtdrucktaste tastend Illuminated Push Button Tentative
	384668
	Leuchtmeldervorsatz Indicating Lamp Bezel
	384670
	Leuchtmeldervorsatz Indicating Lamp Bezel
	384312
	LED-Element Front, rot, 12 - 30 V LED-Element Front, Red

# Ersatzteile Elektro/Elektronik

## Spare Parts Electrics/Electronics





















Darstellung Illustration	Bauer-Best.Nr. Bauer Item No.
	Bezeichnung Description
	384323
	LED-Element Front, grün, 12 - 30 V LED-Element Front, Green
	371769
	Kontaktelement Front, Schließer Contact Element Front, Closing Contact
	384306
	Kontaktelement Boden, Schließer Contact Element Bottom, Closing Contact
	381944
	LED-Element Boden, weiß, 12 - 30 V LED-Element Bottom, White
	384345
	LED-Element Boden, grün, 12 - 30 V LED-Element Bottom, Green
	371751
	NOT-AUS Emergency-Off
	789087
	NOT-AUS mit Gehäuse kpl. Emergency-Off with Casing cpl.
	407458
	Summer Buzzer
	425782
	Plombierhaube Sealing Cap
	371770
	LED-Element Front, weiß, 85 - 264 V LED-Element Front, White

Darstellung Illustration	Bauer-Best.Nr. Bauer Item No.
	Bezeichnung Description
	371767
	Befestigungsadapter 3-fach Fixed Adapter 3-fold
	371768
	Kontaktelement Front, Öffner Contact Element Front, Opening Contact
	384307
	Kontaktelement Boden, Öffner Contact Element Bottom, Opening Contact
	384342
	LED-Element Boden, rot, 12 - 30 V LED-Element Bottom, Red
	386236
	Blindverschluss Blind Plug
	482390
	NOT-AUS beleuchtet Emergency-Off Illuminated
	407459
	Akustikmelder Sounder Alert
	59594
	Tastenzusatzschild Additional Key Label
	384325
	LED-Element Front, rot, 85 - 264 V LED-Element Front, Red

# Ersatzteile Elektro/Elektronik

## Spare Parts Electrics/Electronics

Darstellung Illustration	Bauer-Best.Nr. Bauer Item No.
	Bezeichnung Description
	384326
	LED-Element Front, grün, 85 - 264 V LED-Element Front, Green
	384351
	LED-Element Boden, rot, 85 - 264 V LED-Element Bottom, Red
	387417
	Gehäuse 1-fach Casing 1-fold
	262520
	Fernsteuerungsgehäuse Remote Control Hosing
	262522
	Hilfsschalter 1x NO, 1x NC, tastend Auxiliary Contact Tentative
	356620
	Schild für Schalter Sign for Switch
	65411
	Schutzkappe weiß Protection Cap White
	65412
	Schutzkappe schwarz Protection Cap Black
	607776
	Meldeleuchte rot Signal Lamp Red
	25588
	Glühlampe Light Bulb









Darstellung Illustration	Bauer-Best.Nr. Bauer Item No.
	Bezeichnung Description
	384350
	LED-Element Boden, weiß, 85 - 264 V LED-Element Bottom, White
	384352
	LED-Element Boden, grün, 85 - 264 V LED-Element Bottom, Green
	381945
	Tasterkappe transparent Push Button Cap Hyaline, Transparent
	262523
	Notaus-Taster Emergency-Off Button
	356618
	Wahlschalter 3-Raststellungen Selector Switch 3-indexed Positions
	356619
	Hilfsschalter 2x NO, tastend Auxiliary Contact Tentative
	262515
	Schild für Schalter Sign for Switch
	262516
	Schild für Schalter Sign for Switch
	262521
	Hilfsschalter Auxiliary Contact
	262527
	Lampenfassung Lamp Socket



# Ersatzteile Elektro/Elektronik

## Spare Parts Electrics/Electronics





### Sensoren | Sensors

Darstellung Illustration	Bauer-Best.Nr. Bauer Item No.	Bezeichnung Description
	66412	Inklinometer X, Y +/- 5,75° <a href="#">Inclinometer</a>
	68530	Neigungswinkel Messeinrichtung 2 x 45°, 4 - 20 mA, inkl. 5 m Kabel, freies Ende <a href="#">Inclinometer Measuring Device, incl. 5 m Cable, Free Wires</a>
	860297	Neigungssensor CAN-Bus, Variante 1 <a href="#">Inclinometer CAN-Bus, Variant 1</a>
	866727	Neigungssensor CAN-Bus, Variante 2 <a href="#">Inclinometer CAN-Bus, Variant 2</a>
	503305	Neigungssensor zweiachsig, vertikal <a href="#">Inclinometer Two Axis, Vertical</a>
-	1334195	Neigungssensor, Variante 1 <a href="#">Inclinometer, Variant 1</a>
-	1334197	Neigungssensor, Variante 2 <a href="#">Inclinometer, Variant 2</a>
	630310	Ultraschallsensor, Kellyvisualisierung <a href="#">Ultrasonicsensor, Kelly Visualisation</a>
	268914	Kabeldose M 12, 90°, 5-polig, 10 m (passend zu ID: 630310) <a href="#">Cable Socket 5 pole (fits to ID: 630310)</a>
	1049933	Winkelsensor <a href="#">Angle Sensor</a>





# Ersatzteile Elektro/Elektronik

## Spare Parts Electrics/Electronics

### Batterieanschlüsse | Battery Connectors

Darstellung Illustration	Bauer-Best.Nr. Bauer Item No.	Bezeichnung Description
	25606	Batterieklemme Pluspol, M 10 Battery Terminal Positive Pole
	25607	Batterieklemme Minuspol, M 10 Battery Terminal Negative Pole
	484305	Schutzkappe Batteriepol Protection Cap Battery Terminal
	45194	Batterie Hauptschalter Battery Main Switch
	989021 1336928	Winkelcodierer Angle Encoder

### Tiefenmessung | Depth measurement

Darstellung Illustration	Bauer-Best.Nr. Bauer Item No.	Bezeichnung Description
	43402	Inkremental Drehgeber 360 Impulse Rotary Encoder
	445447	Inkremental Drehgeber 3600 Impulse c/w-Anschlusskabel Rotary Encoder c/w-Cable
	66458	Inkremental Drehgeber 360 Impulse 12-poliger Stecker Rotary Encoder 12-pole Plug
	359300	Inkremental Drehgeber 3600 Impulse 12-poliger Stecker Rotary Encoder 12-pole Plug
	772630	Kabel Tiefenmessung Cable Depth Measurement

**Anywhere -  
from everywhere**



## **Web-BGM - zur digitalen Verwaltung Ihrer Geräteflotte** *For the Digital Administration of your Rig Fleet*





Live-B-Tronic-Bildschirm sowie  
Abfrage von Betriebszeiten, Standort,  
Motor- und Gerätedaten, Störungsmeldungen,  
Wartungs- und Serviceinformationen,  
Produktionsdaten und Kraftstoffverbrauch

*Live-B-Tronic-Screen as well as  
retrieval of operation time, location,  
engine and machinery data, fault messages,  
maintenance and service information,  
production data and fuel consumption*

# Ersatzteile Elektro/Elektronik

## Spare Parts Electrics/Electronics





### Endschalter | Limit Switches

Bauer-Best.Nr. Bauer Item No.	Darstellung Illustration	Bauer-Best.Nr. Bauer Item No.	Bezeichnung Description
848969	Endschalter Kuppelstößel Limit Switch Plunger Type	Bestehend aus:   Consists of:	
 <p>Auslaufmodell   Discontinued Model</p> 		738385	(1x) Positionsschalter mit Stößel Position Switch with Plunger
		365550	(1x) Kabelverschraubung MSR-M 16 x 1,5 Screwed Cable Gland
		371397	(1x) Reduzierring M 20 / M 16 Reducing Ring
		483240	(1x) Dichtring M 20 Sealing Ring
		32292	(4x) Zyl. Schraube mit I-6-kant M 5 x 50 Hexagon Socket Head Cap Screw
		54206	(8x) U-Scheibe Washer
		35000	(4x) Sicherungsmutter 5 Locking Nut
		849000	Endschalter mit Schwenkhebel, kurz, kpl. Limit Switch with Swinging Arm, Short, cpl.
 <p>Auslaufmodell   Discontinued Model</p> 		738464	(1x) Positionsschalter mit Schwenkantrieb Position Switch with Swinging Arm
		365550	(1x) Kabelverschraubung MSR-M 16 x 1,5 Screwed Cable Gland
		371397	(1x) Reduzierring M 20 / M 16 Reducing Ring
		483240	(1x) Dichtring M 20 Sealing Ring
		256114	(2x) Zyl. Schraube mit I-6-kant M 5 x 35 Hexagon Socket Head Cap Screw
		54206	(2x) U-Scheibe Washer
		72218	(4x) Sicherungsscheibe 5 Retaining Washer







# Ersatzteile Elektro/Elektronik

## Spare Parts Electrics/Electronics

Darstellung Illustration	Bauer-Best.Nr. Bauer Item No.	Bezeichnung Description
849005	Endschalter Schwenkhebel mit Rolle Limit Switch Swivelling Arm with Roller	Bestehend aus:   Consists of:
 <p>Auslaufmodell   Discontinued Model</p> 	844847	(1x) Schwenkhebel Endschalter Position Switch Swivelling Lever
	365550	(1x) Kabelverschraubung MSR-M 16 x 1,5 Screwed Cable Gland
	371397	(1x) Reduzierring M 20 / M 16 Reducing Ring
	483240	(1x) Dichtring M 20 Sealing Ring
	256114	(2x) Zyl. Schraube mit I-6-kant M 5 x 35 Hexagon Socket Head Cap Screw
	54206	(2x) U-Scheibe Washer
	72218	(2x) Sicherungsmutter 5 Locking Nut
849011	Endschalter Kuppelstößel - kurz Limit Switch Plunger - Short	Bestehend aus:   Consists of:
 <p>Auslaufmodell   Discontinued Model</p> 	732325	(1x) Positionsschalter mit Einfachstößel Position Switch with Single Plunger
	371179	(1x) Dichtungsnippel Seal Nipple
	371397	(1x) Reduzierring M 20 / M 16 Reducing Ring
	483240	(1x) Dichtring M 20 Sealing Ring
	256114	(2x) Zyl. Schraube mit I-6-kant M 5 x 35 Hexagon Socket Head Cap Screw
	54206	(2x) U-Scheibe Washer
	72218	(2x) Sicherungsmutter 5 Locking Nut

# Ersatzteile Elektro/Elektronik





## Spare Parts Electrics/Electronics

Darstellung Illustration	Bauer-Best.Nr. Bauer Item No.	Bezeichnung Description
	54206	U-Scheibe Washer
	35000	Sicherungsmutter 5 Locking Nut
	32292	Zylindrische Schraube mit Innensechskant M 5 x 50 Hexagon Socket Head Cap Screw
	36713	Zylindrische Schraube mit Innensechskant M 5 x 40 Hexagon Socket Head Cap Screw
	256114	Zylindrische Schraube mit Innensechskant M 5 x 35 Hexagon Socket Head Cap Screw
	868053	Endschalter mit Rollenhebel kpl. M 12, 40 mm Limit Switch with Roller Lever cpl.
	868055	Endschalter Kuppelstößel kpl. M 12, 40 mm Limit Switch Plunger cpl.
	868095	Endschalter Rollenschwenkhebel kpl. M 12, 40 mm Limit Switch with Roller Lever cpl.







# Ersatzteile Elektro/Elektronik

## Spare Parts Electrics/Electronics

Darstellung Illustration	Bauer-Best.Nr. Bauer Item No.	Bezeichnung Description
	868098	Endschalter Schwenkhebel mit Rolle kpl. M 12 (verstellbar) <a href="#">Limit Switch with Roller Lever cpl. M 12 (Adjustable)</a>
	868100	Endschalter Stangenhebel kpl. M 12 (verstellbar) <a href="#">Limit Switch with Rod Lever cpl. (Adjustable)</a>
	868097	Endschalter Rollenstößel kpl. M 12, 40 mm <a href="#">Limit Switch with Roller Plunger cpl.</a>
	922844	Endschalter Kuppelstößel kpl. M 12, 40 mm <a href="#">Limit Switch Plunger cpl.</a>
	940759	Endschalter Rollenhebel kpl. M 12, 40 mm <a href="#">Limit Switch with Roller Lever cpl.</a>

# Ersatzteile Elektro/Elektronik

## Spare Parts Electrics/Electronics

Darstellung Illustration	Bauer-Best.Nr. Bauer Item No.	Bezeichnung Description
	868094	Endschalter Rollenhebel kpl. M 12, 56 mm Limit Switch with Roller Lever cpl.
	868054	Endschalter Kuppelstößel kpl. M 12, 56 mm Limit Switch Plunger cpl.
	868096	Endschalter Rollenschwenkhebel kpl. M 12, 56 mm Limit Switch with Roller Lever cpl.
	868099	Endschalter Rollenschwenkhebel kpl. M 12, 56 mm Limit Switch with Roller Lever cpl.
	913504	Endschalter Rollenschwenkantrieb kpl. M 12 rechts, 56 mm Limit Switch Roller Swivel Drive cpl., right



## Unsere Leistungen







### *Our Services*

- *Wartungs-, Reparaturarbeiten und Generalüberholung durch kompetente Servicetechniker*
- *Gezielte Ferndiagnosen zur schnellen Problembeseitigung durch Maschinendatenübertragung*
- *Remote-Service*
- *Dritoc – Online-Bohrwerkzeugkonfigurator*
- *Maintenance, repairs and general overhaul by specialist technicians*
- *Telemetry and troubleshooting via machine data transmission*
- *Remote Service*
- *Dritoc – online drilling tool configurator*

# Ersatzteile Elektro/Elektronik

## Spare Parts Electrics/Electronics

### Leuchten und Zubehör | Lamps and Accessories

Darstellung Illustration	Bauer-Best.Nr. Bauer Item No.	Bezeichnung Description
LED-Leuchten   <a href="#">LED Lamps</a>		
	1114528	Arbeitsscheinwerfer LED + Halter stehend <a href="#">Working Floodlight LED + Holder Upright</a>
	1123412	Arbeitsscheinwerfer LED + Halter hängend <a href="#">Working Floodlight LED + Holder Inverted</a>
Warneinrichtungen   <a href="#">Warning Devices</a>		
	1358932	Rundumleuchte 24 V <a href="#">Rotating Beam Light</a>
	65425	Rückfahrwarneinrichtung <a href="#">Acoustic Warning Device</a>
	861574	Rückfahrwarner Breitbandton <a href="#">Acoustic Warning Device Broadband Sound</a>
	857182	Warnleuchte <a href="#">Warning Light</a>
	857185	Warnleuchte Slave <a href="#">Warning Light Slave</a>









# Ersatzteile Elektro/Elektronik

## Spare Parts Electrics/Electronics

### Nachrüstung Rückfahrkamera | Retrofit Kit Rear View Camera



Darstellung Illustration	Bauer-Best.Nr. Bauer Item No.	Darstellung Illustration	Bauer-Best.Nr. Bauer Item No.
	Bezeichnung Description		Bezeichnung Description
	658245		439516
	Infrarot Kamera AMOS 118° mit LED und Magnethalter  Infrared Camera AMOS 118° with LED and Magnet Clamp		Farbmonitor Colour Monitor
	1187871		434575 - 2 m 468351 - 5 m 667966 - 11 m 453363 - 16 m
	Infrarot Kamera AMOS 118° mit LED  Infrared Camera AMOS 118° with LED		Kamera Kabel Camera Cable
	970535		439518
	Kamerahalterung mit Magnet und Überdachung  Camera Adjustment with Magnet and Canopy		Kamera Schalter Camera Switch









Falls Sie weitere Fragen haben sollten oder weitere Informationen bezüglich des Anbaus der Kamera benötigen, kontaktieren Sie uns bitte unter [BMA-Parts-and-Service@bauer.de](mailto:BMA-Parts-and-Service@bauer.de)

If you have any further questions or if you require any further information regarding the assembly of the camera please contact us under [BMA-Parts-and-Service@bauer.de](mailto:BMA-Parts-and-Service@bauer.de)

# Ersatzteile Elektro/Elektronik

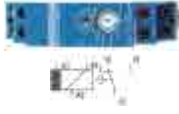
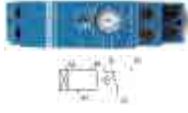
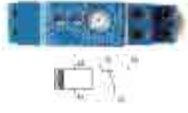
## Spare Parts Electrics/Electronics

### Relais | Relays











Schaltschrankrelais   Switch Cabinet Relay		
Darstellung Illustration	Bauer-Best.Nr. Bauer Item No.	Bezeichnung Description
	260421	Schaltrelais anfügbar 1x UM Switch Relay, Attachable
	38582	Schaltrelais 3x UM Switch Relay
	49576	Sockel für Schaltrelais Socket for Switch Relay
	60665	Haltefeder für Schaltrelais Locking Spring for Switch Relay
Zeitrelais   Time Lag Relay		
Darstellung Illustration	Bauer-Best.Nr. Bauer Item No.	Bezeichnung Description
	66720	Zeitrelais rückfallverzögert Time Lag Relay Off-Delay Function
	66721	Zeitrelais anzugverzögert Time Lag Relay Switch-on Delay
	225220	Zeitrelais Multifunktion Time Lag Relay Multifunctional
	514066	Zeitrelais anzugverzögert 5 Sek. Time Lag Relay, Switch-on Delay 5 Sec.
Kfz-Relais   Automotive Relay		
Darstellung Illustration	Bauer-Best.Nr. Bauer Item No.	Bezeichnung Description
	1030154	Kfz-Wechselrelais 24 V, 30 A Automotive Changeover Relay
	370502	Kfz-Doppel-Schließerrelais 24 V, 2x 30 A Automotive Double Make Contact Relay



# Ersatzteile Elektro/Elektronik

## Spare Parts Electrics/Electronics

### Sicherungsautomaten | Circuit Breakers









Darstellung Illustration	Bauer-Best.Nr. Bauer Item No.	Bezeichnung Description
	835227	Leitungsschutzschalter C25A Circuit Breaker
	835228	Leitungsschutzschalter C40A Circuit Breaker
	835229	Leitungsschutzschalter C50A Circuit Breaker
	835230	Leitungsschutzschalter C63A Circuit Breaker
	60233	Sicherungsautomat 1 A Circuit Breaker
	60099	Sicherungsautomat 2 A Circuit Breaker
	60098	Sicherungsautomat 5 A Circuit Breaker
	60096	Sicherungsautomat 8 A Circuit Breaker
	60097	Sicherungsautomat 10 A Circuit Breaker
	60618	Sicherungsautomat 16 A Circuit Breaker

# Ersatzteile Elektro/Elektronik

## Spare Parts Electrics/Electronics

### Elektro-Steckverbinder Harting | Electric Connections Harting















Harting Stecker, 6-polig B (schwer)   Harting Plug, 6-pole B (heavy)					
Darstellung Illustration	Bauer-Best.Nr. Bauer Item No.	Bezeichnung Description	Darstellung Illustration	Bauer-Best.Nr. Bauer Item No.	Bezeichnung Description
	39179	Steckdoseneinsatz 6-polig Socket Insert 6 pole		372876	Socketgehäuse mit Deckel 6-polig, M 20 Socket Housing with Cover 6 pole
	39181	Steckereinsatz 6-polig Plug Insert 6 pole		<b>Kabelverschraubung</b> <b>Cable Gland</b>	
				365551	M 20, 4 - 8 mm
			365890	M 20, 6 - 13 mm	
	372860	Tüllengehäuse seitlich 6-polig, M 20 Sleeve Housing, Laterally 6 pole	 oder   or  + 	<b>Verschluss für Socketgehäuse</b> <b>Sealing for Socket Housing</b>	
				371384	Verschlussnippel M 20 Seal Nipple
				371396	Reduzierring M 20 - M 12 Reduction Ring
	372862	Tüllengehäuse gerade 6-polig, M 20 Sleeve Housing, Straight 6 pole	407417	Entwässerung M 12 Drainage	



# Ersatzteile Elektro/Elektronik

## Spare Parts Electrics/Electronics

Harting Stecker, 10-polig B (schwer)   Harting Plug, 10-pole B (heavy)					
Darstellung Illustration	Bauer-Best.Nr. Bauer Item No.	Bezeichnung Description	Darstellung Illustration	Bauer-Best.Nr. Bauer Item No.	Bezeichnung Description
	60377	Steckdoseneinsatz 10-polig Socket Insert 10 pole		372878	Socketgehäuse mit Deckel 10-polig, M 20 Socket Housing with Cover 10 pole
	60376	Steckereinsatz 10-polig Plug Insert 10 pole		<b>Kabelverschraubung</b> <b>Cable Gland</b>	
				365551	M 20, 4 - 8 mm
			365890	M 20, 6 - 13 mm	
	372864	Tüllengehäuse seitlich 10-polig, M 20 Sleeve Housing, Laterally 10 pole		<b>Verschluss für Socketgehäuse</b> <b>Sealing for Socket Housing</b>	
				371384	Verschlussnippel M 20 Seal Nipple
				371396	Reduzierring M 20 - M 12 Reduction Ring
	372870	Tüllengehäuse gerade 10-polig, M 20 Sleeve Housing, Straight 10 pole	407417	Entwässerung M 12 Drainage	
	1327658	Aufnahmemodul Bus Buchse Module Bus Female	-	664855	Aufbaurahmen Buchse Frame Female
-	1327659	Aufnahmemodul Bus Stift Module Bus Male		664856	Aufbaurahmen Stift Frame Male
-	1327658	Kontaktträger Bus Buchse 4-polig Carrier Bus Female 4 pole		370475	Crimpkontakt Stift 0,5 mm <sup>2</sup> Crimp Contact Pin
	1327659	Kontaktträger Bus Stift 4-polig Carrier Bus Male 4 pole		370476	Crimpkontakt Buchse 0,5 mm <sup>2</sup> Crimp Contact Bushing

# Ersatzteile Elektro/Elektronik

## Spare Parts Electrics/Electronics

Harting Stecker, 15-polig DD (Crimp)   Harting Plug, 15-pole DD (Crimp)					
Darstellung Illustration	Bauer-Best.Nr. Bauer Item No.	Bezeichnung Description	Darstellung Illustration	Bauer-Best.Nr. Bauer Item No.	Bezeichnung Description
	205973	Steckereinsatz 15-polig Plug Insert, 15 pole		375965	Socketgehäuse mit Deckel 15-polig, M 20 Socket Housing with Cover 15 pole
	370476 68687 68688	Crimpkontakt Buchse Crimp Contact Socket 0,5 mm <sup>2</sup> 0,75 - 1 mm <sup>2</sup> 1,5 mm <sup>2</sup>			
	205974	Steckereinsatz 15-polig Plug Insert, 15 pole		<b>Kabelverschraubung</b> <b>Cable Gland</b>	
	370475 68685 68686	Crimpkontakt Stift Crimp Contact Pin 0,5 mm <sup>2</sup> 0,75 - 1 mm <sup>2</sup> 1,5 mm <sup>2</sup>		365551	M 20, 4 - 8 mm
	372852	Tüllengehäuse seitlich 10-polig L. + 15-polig Cr., M 20 Sleeve Housing, Laterally, 10 pole light + 15 pole Cr.		<b>Verschluss für Socketgehäuse</b> <b>Sealing for Socket Housing</b>	
	372854	Tüllengehäuse gerade 15-polig, M 20 Sleeve Housing, Straight 15 pole		371384	Verschlussnippel M 20 Seal Nipple
				371396	Reduzierring M 20 - M 12 Reduction Ring
				407417	Entwässerung M 12 Drainage
Harting Stecker, 16-polig B (schwer)   Harting Plug, 16-pole B (heavy)					
Darstellung Illustration	Bauer-Best.Nr. Bauer Item No.	Bezeichnung Description	Darstellung Illustration	Bauer-Best.Nr. Bauer Item No.	Bezeichnung Description
	44186	Steckdoseneinsatz 16-polig Socket Insert 16 pole		372879	Socketgehäuse mit Deckel 16-polig, M 25 Socket Housing with Cover 16 pole
	60066	Steckereinsatz 16-polig Plug Insert 16 pole		<b>Kabelverschraubung</b> <b>Cable Gland</b>	
	372866	Tüllengehäuse seitlich 16-polig, M 25 Sleeve Housing, Laterally 16 pole		365562	M 25, 7 - 12 mm
	372872	Tüllengehäuse gerade 16-polig, M 25 Sleeve Housing, Straight 16 pole		365891	M 25, 9 - 17 mm
				<b>Verschluss für Socketgehäuse</b> <b>Sealing for Socket Housing</b>	
				371385	Verschlussnippel M 25 Seal Nipple
				407418	Entwässerung M 25 Drainage

# Ersatzteile Elektro/Elektronik

## Spare Parts Electrics/Electronics



### Harting Stecker, 24-polig B (schwer) | Harting Plug, 24-pole B (heavy)















Darstellung Illustration	Bauer-Best.Nr. Bauer Item No.	Bezeichnung Description	Darstellung Illustration	Bauer-Best.Nr. Bauer Item No.	Bezeichnung Description
	49109	Steckdoseneinsatz 24-polig Socket Insert 24 pole		372881	Socketgehäuse mit Deckel 24-polig, M 25 Socket Housing with Cover 24 pole
	49108	Steckereinsatz 24-polig Plug Insert 24 pole	<b>Kabelverschraubung</b> <b>Cable Gland</b>		
	372868	Tüllengehäuse seitlich 24-polig, M 25 Sleeve Housing, Laterally 24 pole		365562	M 25, 7 - 12 mm
	372874	Tüllengehäuse gerade 24-polig, M 25 Sleeve Housing, Straight 24 pole		365891	M 25, 9 - 17 mm
			<b>Verschluss für Socketgehäuse</b> <b>Sealing for Socket Housing</b>		
				371385	Verschlussnippel M 25 Seal Nipple
				407418	Entwässerung M 25 Drainage

### Harting Stecker, 25-polig DD (Crimp) | Harting Plug, 25-pole DD (Crimp)

Darstellung Illustration	Bauer-Best.Nr. Bauer Item No.	Bezeichnung Description	Darstellung Illustration	Bauer-Best.Nr. Bauer Item No.	Bezeichnung Description
	207553	Steckereinsatz 25-polig Plug Insert, 25 pole		375971	Socketgehäuse mit Deckel 16-polig L. + 25-polig Cr. - M 20 Socket Housing with Cover 24 pole light + 25 pole Cr.
	68687 68688	Crimpkontakt Buchse Crimp Contact Socket 0,75 - 1 mm <sup>2</sup> 1,5 mm <sup>2</sup>	<b>Kabelverschraubung</b> <b>Cable Gland</b>		
	207554	Steckereinsatz 25-polig Plug Insert, 25 pole		365551	M 20, 4 - 8 mm
	68685 68686	Crimpkontakt Stift Crimp Contact Pin 0,75 - 1 mm <sup>2</sup> 1,5 mm <sup>2</sup>		365890	M 20, 6 - 13 mm
	372856	Tüllengehäuse seitlich 16-polig L. + 25-polig, M 20 Sleeve Housing, Laterally 16 pole light + 25 pole	<b>Verschluss für Socketgehäuse</b> <b>Sealing for Socket Housing</b>		
	372858	Tüllengehäuse gerade 15-polig, M 20 Sleeve Housing, Straight 15 pole		371384	Verschlussnippel M 20 Seal Nipple
				371396	Reduziererring M 20 - M 12 Reduction Ring
				407417	Entwässerung M 12 Drainage

# Ersatzteile Elektro/Elektronik







## Spare Parts Electrics/Electronics

Harting Stecker, 72-polig DD (Crimp)   Harting Plug, 72-pole DD (Crimp)					
Darstellung Illustration	Bauer-Best.Nr. Bauer Item No.	Bezeichnung Description	Darstellung Illustration	Bauer-Best.Nr. Bauer Item No.	Bezeichnung Description
	68684	Steckdoseneinsatz 72-polig Plug Insert, 72 pole		372880	Sockelgehäuse mit Deckel 72-polig, M 32 Socket Housing with Cover 72 pole
	68687	Crimpkontakt Buchse 0,75 - 1 mm <sup>2</sup>			
	68688	Crimpkontakt Stift 1,5 mm <sup>2</sup> Crimp Contact Socket			
	68683	Steckereinsatz 72-polig Plug Insert, 72 pole		<b>Kabelverschraubung Cable Gland</b>	
	68685	Crimpkontakt Stift 0,75 - 1 mm <sup>2</sup>		371392	Erweiterung M 32 - M 40 Flaring
	68686	Crimpkontakt Stift 1,5 mm <sup>2</sup>		365913	M 40, 16 - 28 mm
	372867	Tüllengehäuse seitlich 72-polig, M 32 Sleeve Housing, Laterally 72 pole		<b>Verschluss für Sockelgehäuse Sealing for Socket Housing</b>	
	372873	Tüllengehäuse gerade 72-polig, M 32 Sleeve Housing, Straight 72 pole		371386	Verschlussnippel M 32 Seal Nipple
				371401	Reduzierring M 32 - M 25 Reduction Ring
			407418	Entwässerung M 25 Drainage	
Harting Stecker, 10-polig A (leicht)   Harting Plug, 10-pole A (light)					
Darstellung Illustration	Bauer-Best.Nr. Bauer Item No.	Bezeichnung Description	Darstellung Illustration	Bauer-Best.Nr. Bauer Item No.	Bezeichnung Description
	39703	Steckdoseneinsatz 10-polig Socket Insert 10 pole		375965	Sockelgehäuse mit Deckel 10-polig L. + 15-polig Cr., M 20 Socket Housing with Cover 10 pole light, 15 pole Cr.
	39695	Steckereinsatz 10-polig Plug Insert 10 pole		<b>Kabelverschraubung Cable Gland</b>	
				365551	M 20, 4 - 8 mm
				365890	M 20, 6 - 13 mm
	372852	Tüllengehäuse seitlich 10-polig L. + 15-polig Cr., M 20 Sleeve Housing, Laterally 10 pole light, 15 pole Cr.		<b>Verschluss für Sockelgehäuse Sealing for Socket Housing</b>	
	372854	Tüllengehäuse gerade 10-polig L. + 15-polig Cr., M 20 Sleeve Housing, Straight 10 pole light, 15 pole Cr.		371384	Verschlussnippel M 20 Seal Nipple
				371396	Reduzierring M 20 - M 12 Reduction Ring
			407417	Entwässerung M 12 Drainage	

# Ersatzteile Elektro/Elektronik

## Spare Parts Electrics/Electronics



Harting Stecker, 16-polig A (leicht)   Harting Plug, 16-pole A (light)					
Darstellung Illustration	Bauer-Best.Nr. Bauer Item No.	Bezeichnung Description	Darstellung Illustration	Bauer-Best.Nr. Bauer Item No.	Bezeichnung Description
	39814	Steckdoseneinsatz 16-polig Socket Insert 16 pole		375971	Sockelgehäuse mit Deckel 16-polig L. + 25-polig Cr., M 20 Socket Housing with Cover 16 pole light + 25 pole Cr.
	39815	Steckereinsatz 16-polig Plug Insert 16 pole		<b>Kabelverschraubung</b> <b>Cable Gland</b>	
				365551	M 20, 4 - 8 mm
			365890	M 20, 6 - 13 mm	
	372856	Tüllengehäuse seitlich 16-polig L. + 25-polig Cr., M 20 Sleeve Housing, Laterally 16 pole light + 25 pole Cr.	 oder   or	<b>Verschluss für Sockelgehäuse</b> <b>Sealing for Socket Housing</b>	
				371384	Verschlussnippel M 20 Seal Nipple
				371396	Reduzierring M 20 - M 12 Reduction Ring
	372858	Tüllengehäuse gerade 16-polig L. + 25-polig Cr., M 20 Sleeve Housing, Straight 16 pole light + 25 pole Cr.		407417	Entwässerung M 12 Drainage



## **Bauer Original-Ersatzteile** *Bauer Original Spare Parts*











- 35 Ersatzteilstützpunkte weltweit, dadurch hohe Flexibilität und Verfügbarkeit von Teilen
- ca. 100.000 verschiedene Teile weltweit verfügbar
- 95 % Teileverfügbarkeit
- BAUER Service-Koffer – die kompakten Ersatzteilsets für die schnelle Reparatur
- Individuelle Ersatzteil- und Servicepakete
- Generalüberholte Teile
- *High availability of spares as well as flexibility due to more than 35 spare parts centers worldwide*
- *Around 100,000 different spare parts are available worldwide*
- *Availability of 95% of spares*
- *Experience-based packages in our Bauer Service cases to minimize down time*
- *Specific parts and service packages for equipment*
- *Reconditioned parts*



# Ersatzteile Elektro/Elektronik





## Spare Parts Electrics/Electronics

### Kabel | Cables

Darstellung Illustration	Bauer-Best.Nr. Bauer Item No.	Bezeichnung Description
	356329	Ventilsteckerkabel 5 m, Typ A Valve Connector Cable Type A
	356328	Ventilsteckerkabel 10 m, Typ A Valve Connector Cable Type A
	392016	Ventilsteckerkabel 2-polig, AMP, 5 m Valve Cable 2 pole AMP, 2 pole
	377926	Steckverbinder Multipole Connector
	733772	Ventilstecker Adapter M 12, 5-polig, hinten Valve Connection Adapter, 5 pole, Rear
	733773	Ventilstecker Adapter M 12, 5-polig, oben Valve Connection Adapter, 5 pole, Top
	376595	Druckschalterkabel 5 m Press Switch Cable
	861510	Druckschalterkabel 10 m Press Switch Cable
	656462	Kabel M 12, 90°, 4-polig mit LED, 10 m Cable 4 pole with LED, 4 pole
	915911	Kabeldose M 12, 4-polig, 3 LED, 10 m Cable Socket 4 pole
	469963	Kabeldose M 12, gerade, 5-polig, 10 m Cable Socket Straight, 5 pole
	678053	Kabeldose M 12, 90°, 4-polig, 10 m Cable Socket 4 pole
	771257	Ventilanschlusskabel 10 m, 2-polig, Deutsch Valve Connection Cable 2 pole
	772630	Tiefenmesskabel kpl., 2 m Depth Measurement Cable cpl.

# Ersatzteile Elektro/Elektronik

## Spare Parts Electrics/Electronics

Darstellung Illustration	Bauer-Best.Nr. Bauer Item No.	Bezeichnung Description	Verpackungseinheit Packaging Unit
	246667	Verdrahtungsleitung blau, 1 x 0,75 mm <sup>2</sup> Wiring Conductor Blue	Ganze Spule 250 m Complete Drum
	246668	Verdrahtungsleitung braun, 1 x 0,75 mm <sup>2</sup> Wiring Conductor Brown	
	246669	Verdrahtungsleitung schwarz, 1 x 0,75 mm <sup>2</sup> Wiring Conductor Black	
	615963	Verdrahtungsleitung rot, 0,75 mm <sup>2</sup> Wiring Conductor Red	
	246665	Verdrahtungsleitung dunkelblau, 1 x 1 mm <sup>2</sup> Wiring Conductor Dark Blue	Ganze Spule 150 m Complete Drum
	246666	Verdrahtungsleitung black, 1 x 1 mm <sup>2</sup> Wiring Conductor Black	
	609366	Verdrahtungsleitung blue, 1,5 mm <sup>2</sup> Wiring Conductor Blue	
	497744	Verdrahtungsleitung braun, 1,5 mm <sup>2</sup> Wiring Conductor Brown	Ganze Spule 100 m Complete Drum
	497742	Verdrahtungsleitung black, 1,5 mm <sup>2</sup> Wiring Conductor Black	
	609367	Verdrahtungsleitung red, 1,5 mm <sup>2</sup> Wiring Conductor Red	
	517295	Verdrahtungsleitung blau, 2,5 mm <sup>2</sup> Wiring Conductor Blue	Meterware Cut Goods
	497745	Verdrahtungsleitung braun, 2,5 mm <sup>2</sup> Wiring Conductor Brown	
	497743	Verdrahtungsleitung schwarz, 2,5 mm <sup>2</sup> Wiring Conductor Black	
	264798	Verdrahtungsleitung blau, H07V-K, 4 mm <sup>2</sup> Wiring Conductor Blue	Meterware Cut Goods
	54305	Verdrahtungsleitung braun, 1 x 4 mm <sup>2</sup> Wiring Conductor Brown	
	264801	Verdrahtungsleitung blau, H07V-K, 6 mm <sup>2</sup> Wiring Conductor Blue	
	43324	Verdrahtungsleitung braun, 1 x 6 mm <sup>2</sup> Wiring Conductor Brown	
	264800	Verdrahtungsleitung schwarz, H07V-K, 6 mm <sup>2</sup> Wiring Conductor Black	

Bei Meterware Mindestabnahme von 10 m.  
With cut goods minimum purchase quantity of 10 m.



# Ersatzteile Elektro/Elektronik











## Spare Parts Electrics/Electronics

Darstellung Illustration	Bauer-Best.Nr. Bauer Item No.	Bezeichnung Description	Verpackungseinheit Packaging Unit
	246671	Verdrahtungsleitung braun 1 x 10 mm <sup>2</sup> Wiring Conductor Brown	Meterware Cut Goods
	246670	Verdrahtungsleitung schwarz 1 x 10 mm <sup>2</sup> Wiring Conductor Black	
	264804	Verdrahtungsleitung blau H07V-K, 10 mm <sup>2</sup> Wiring Conductor Blue	
	941434	Verdrahtungsleitung braun H07V-K, 16 mm <sup>2</sup> Wiring Conductor Brown	
	264806	Verdrahtungsleitung schwarz H07V-K, 16 mm <sup>2</sup> Wiring Conductor Black	
	365903	Buskabel 1 x 2 x 0,22 mm <sup>2</sup> Bus Cable	Meterware Cut Goods
	594668	Kabel CAN-Bus 1 x 2 x AWG24 + 1 x 2 x AWG22 Cable CAN-Bus	
	700673	Datenkabel mit Schirm 7 x 0,25 mm <sup>2</sup> Shield Data Cable	
	49025	Datenkabel mit Schirm 7 x 0,34 mm <sup>2</sup> Shield Data Cable	
	51042	Datenkabel mit Schirm 10 x 0,34 mm <sup>2</sup> Shield Data Cable	

Bei Meterware Mindestabnahme von 10 m.  
With cut goods minimum purchase quantity of 10 m.

# Ersatzteile Elektro/Elektronik

## Spare Parts Electrics/Electronics



Darstellung Illustration	Bauer-Best.Nr. Bauer Item No.	Bezeichnung Description	Verpackungseinheit Packaging Unit	
	67059	PVC-Kabel 2 x 0,75 mm <sup>2</sup> PVC-Cable		
	67067	PVC-Kabel 2 x 1,5 mm <sup>2</sup> PVC-Cable		
	67086	PVC-Kabel 3 x 0,75 mm <sup>2</sup> PVC-Cable		
	67087	PVC-Kabel 4 x 0,75 mm <sup>2</sup> PVC-Cable		
	67089	PVC-Kabel 6 x 0,75 mm <sup>2</sup> PVC-Cable		
	67088	PVC-Kabel 10 x 0,75 mm <sup>2</sup> PVC-Cable		Meterware Cut Goods
	596109	PVC-Kabel 12 x 0,75 mm <sup>2</sup> PVC-Cable		
	67090	PVC-Kabel 16 x 0,75 mm <sup>2</sup> PVC-Cable		
	67064	PVC-Kabel 25 x 0,75 mm <sup>2</sup> PVC-Cable		
	67075	PVC-Kabel 50 x 0,75 mm <sup>2</sup> PVC-Cable		
	67094	PVC-Kabel 25 x 1,5 mm <sup>2</sup> PVC-Cable		

Bei Meterware Mindestabnahme von 10 m.  
With cut goods minimum purchase quantity of 10 m.





# Ersatzteile Elektro/Elektronik

## Spare Parts Electrics/Electronics

Darstellung Illustration	Bauer-Best.Nr. Bauer Item No.	Bezeichnung Description	Verpackungseinheit Packaging Unit
	901610	Kabel, Ölflex Classic 110 34 x 1,5 mm <sup>2</sup> Cable Ölflex Classic	Meterware Cut Goods
	249314	Kabel, Ölflex Classic 110 80 x 0,75 mm <sup>2</sup> Cable Ölflex Classic 110	
	793660	Hybridrundkabel 20 x 0,75 mm <sup>2</sup> + 2 x 2 x 0,25 mm <sup>2</sup> Hybrid Round Cable	

### Kabelschutz | Cable Protection







Darstellung Illustration	Bauer-Best.Nr. Bauer Item No.	Bezeichnung Description	Passendes Kabel Fitting Sealing
	412352	Wellrohr NW 6 Corrugated Pipe	2 x 0,75 / 3 x 0,75
	615377	Wellrohr NW 8,5 geschlitzt Corrugated Pipe, Slotted	für Kamerakabel (Seite 272) for Camera Cable (Page 272)
	250387	Wellrohr NW 10 Corrugated Pipe	4 x 0,75 / 6 x 0,75 / 2 x 1,5
	250388	Wellrohr NW 13 Corrugated Pipe	10 x 0,75
	250389	Wellrohr NW 17 Corrugated Pipe	16 x 0,75 / 25 x 0,75
	245951	Wellrohr NW 23 Corrugated Pipe	25 x 1,5 / 34 x 1,5
	813718	Wellrohr NW 29 Corrugated Pipe	50 x 0,75 / 80 x 0,75
	375986	Wellrohr NW 37 Corrugated Pipe	-
	375987	Wellrohr NW 50 Corrugated Pipe	-
	30178	Kabelbinder schwarz, 563 x 12,7 mm Cable Tie Black	
	24647	Kabelbinder weiß, 300 x 4,6 mm Cable Tie White	

Bei Meterware Mindestabnahme von 10 m.  
With cut goods minimum purchase quantity of 10 m.

# Ersatzteile Elektro/Elektronik

## Spare Parts Electrics/Electronics

### Allgemeine Elektrikteile und Werkzeuge | General Electric Parts and Tools

Darstellung Illustration	Bauer-Best.Nr. Bauer Item No.	Bezeichnung Description
	901382	Aderendhülse 0,75 mm <sup>2</sup> Conductor Sleeve
	901383	Aderendhülse 1,5 mm <sup>2</sup> Conductor Sleeve
	370475	Crimpkontakt Stift 0,5 mm <sup>2</sup> Crimp Contact Pin
	68685	Crimpkontakt Stift 0,75 - 1 mm <sup>2</sup> Crimp Contact Pin
	68686	Crimpkontakt Stift 1,5 mm <sup>2</sup> Crimp Contact Pin
	370476	Crimpkontakt Buchse 0,5 mm <sup>2</sup> Crimp Contact Pin
	68687	Crimpkontakt Buchse 0,75 - 1 mm <sup>2</sup> Crimp Contact Bushing
	68688	Crimpkontakt Buchse 1,5 mm <sup>2</sup> Crimp Contact Bushing
	246649	Ausdrückwerkzeug, Harting Crimpkontakt Extraction Tool, Harting Crimp Contact
	90007	Schraubendreher mit KS-Heft 3,5 x 90 Screwdriver Plastic Grip
	733283	Crimpzange ohne Einsatz Crimping Tool without Insert







Im Kapitel **BAUER Service-Koffer** finden Sie unsere Steckverbindersortimente und weiteres Zubehör.

In section **BAUER Service Cases** you'll find our pin and socket connection assortments and additional accessories.



# Ersatzteile Elektro/Elektronik

## Spare Parts Electrics/Electronics

Darstellung Illustration	Bauer-Best.Nr. Bauer Item No.	Bezeichnung Description
	733285	Crimpeinsatz Aderendhülse Crimp Insert Conductor Sleeve
	733287	Crimpeinsatz Crimpkontakt Crimp Insert Crimp Contact
	409060	Crimpzangen Set Crimping Tool Set
	849927	Service Box Steckverbindersortiment ELO Service Box - Pin/Socket Connection
	1077442	Entriegelungswerkzeug Set Unlocking Tool Set



## Hydraulik Hydraulics

---



### Ersatzteile Hydraulik Spare Parts Hydraulics

270 - 283

- Hydraulik-Kupplungen und Zubehör  
Hydraulic Couplings and Accessories
- Kugelhähne  
Ball Valves

270 - 282

283

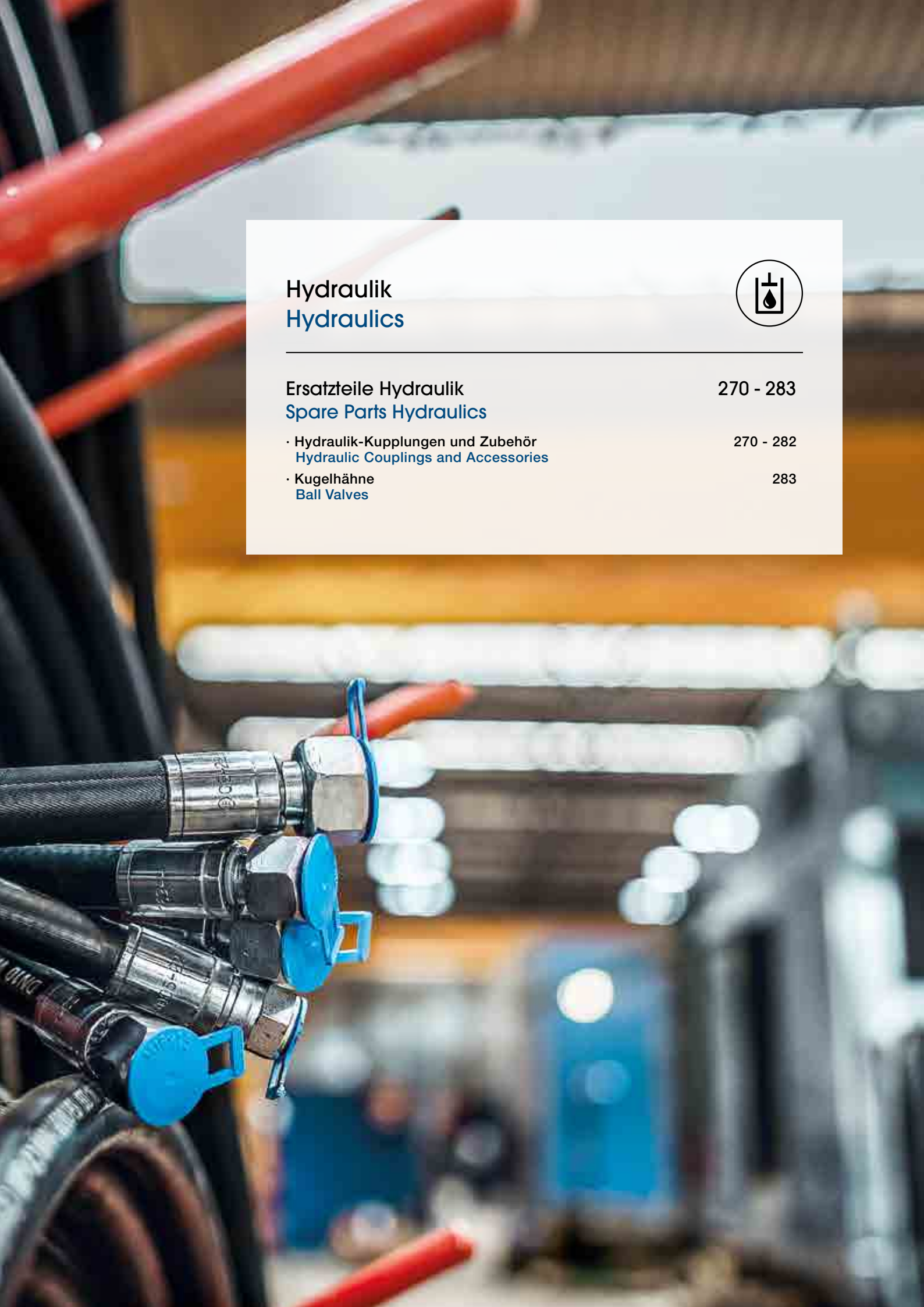

# Ersatzteile Hydraulik

## Spare Parts Hydraulics

### Hydraulik-Kupplungen und Zubehör | Hydraulic Couplings and Accessories



Darstellung Illustration	Bauer-Best.Nr. Bauer Item No.	Ehemalige Bauer-Best.Nr. Previous Bauer Item No.	Bezeichnung Description	Baugröße Construction Size	Nenn- weite Size	Anschluss Connection	Bauer-Best.Nr. Bauer Item No.
							Bezeichnung Description
	1065134	(237384*)	Kupplungs- muffe Coupling Female	2 Ø RD	8	M 20 x 1,5 12 S	26865 Verschluss- mutter Lock Nut
	595327	(378686*)	Kupplg.muffe für Schottplat- tenmontage Coupling Female for Bulkhead	Ø RD 28 x 2	8	M 16 x 1,5 10 L L: 26 mm	
	1065158	(26866*)			8	M 20 x 1,5 12 S L: 27 mm	
	1043600	(21921*)	Kupplungs- muffe Coupling Female	2 Ø RD Ø RD 32 x 3	6	M 18 x 1,5 10 S	1049404 Verschluss- mutter Lock Nut
	1043611	(27011*)			8	M 20 x 1,5 12 S	
	1043599	(21062*)			10	M 18 x 1,5 12 L	
	1065186	(63747*)	Kupplungs- stecker Coupling Male	2 Ø AD Ø OD 34 mm	8	M 20 x 1,5 12 S	26867 Verschluss- schraube Screw Plug
	1043615	(26934*)		2 Ø AD Ø OD 39 mm	6	M 18 x 1,5 10 S	1049403 Verschluss- schraube Screw Plug
	1043616	(32128*)			8	M 20 x 1,5 12 S	
	1043614	(21054*)			10	M 18 x 1,5 12 L	

\*Abweichende Maße der ersetzten Kupplungen erhalten Sie auf Anfrage. | Please find divergent dimensions of replaced couplings on request.

Passende Kennzeichnungsringe erhalten Sie auf Anfrage. | Suitable Identification Rings on request.



# Ersatzteile Hydraulik

## Spare Parts Hydraulics

Darstellung Illustration	Bauer-Best.Nr. Bauer Item No.	Ehemalige Bauer-Best.Nr. Previous Bauer Item No.	Bezeichnung Description	Baugröße Construction Size	Nenn- weite Size	Anschluss Connection	Bauer-Best.Nr. Bauer Item No.
							Bezeichnung Description
	916819	-	Kupplg.stecker für Schottplat- tenmontage  Coupling Male for Bulkhead	2 Ø AD Ø OD 40 mm	10	M 18 x 1,5 12 L L: 36 mm	1049403 Verschluss- schraube  Screw Plug
	1043693	(30599*)	Kupplungs- muffe  Coupling Female	3 Ø RD Ø RD 36 x 3	12	M 24 x 1,5 16 S	1049389 Verschluss- mutter  Lock Nut
	1043692	(73674*)			12	M 22 x 1,5 15 L	
	1065133	(243013*)	Kupplungs- muffe für Schottplat- tenmontage  Coupling Female for Bulkhead	3 Ø RD Ø RD 36 x 2	10	M 18 x 1,5 12 L	1049446 Verschluss- mutter  Lock Nut
	1050766	(243014*) (360990*)			12	M 22 x 1,5 15 L	
	1050768	(27537*) (87707*)			12	M 24 x 1,5 16 S	
	1050764	(26872*) (389645*)	Kupplg.muffe für Schottplat- tenmontage  Coupling Female for Bulkhead	3 Ø RD Ø RD 36 x 2	12	M 22 x 1,5 15 L L: 27 mm	1049446 Verschluss- mutter  Lock Nut
	1057743	(364875*)	Kupplungs- stecker  Coupling Male	3 Ø AD Ø OD 42 mm	12	M 24 x 1,5 16 S L: 29 mm	1049441 Verschluss- schraube  Screw Plug
	1065185	(242841*)	Kupplungs- stecker  Coupling Male	3 Ø AD Ø OD 42 mm	10	M 18 x 1,5 12 L	1049441 Verschluss- schraube  Screw Plug
	1050714	(26873*) (360991*)			12	M 22 x 1,5 15 L	
	1052132	(63754*) (87710*)			12	M 22 x 1,5 16 S	

\*Abweichende Maße der ersetzten Kupplungen erhalten Sie auf Anfrage. | Please find divergent dimensions of replaced couplings on request.

Passende Kennzeichnungsringe erhalten Sie auf Anfrage. | Suitable Identification Rings on request.

# Ersatzteile Hydraulik

## Spare Parts Hydraulics

Darstellung Illustration	Bauer-Best.Nr. Bauer Item No.	Ehemalige Bauer-Best.Nr. Previous Bauer Item No.	Bezeichnung Description	Baugröße Construction Size	Nenn- weite Size	Anschluss Connection	Bauer-Best.Nr. Bauer Item No.
							Bezeichnung Description
	394927	-	Kupplungs- stecker für Schottplatten- montage  Coupling Male for Bulkhead	3 Ø AD  Ø OD 42 mm	12	M 22 x 1,5 15 L L: 27 mm	1049441 Verschluss- schraube  Screw Plug
	718655	-			12	M 24 x 1,5 16 S L: 29 mm	
	1043695	(36094*)	Kupplungs- stecker  Coupling Male	3 Ø AD  Ø OD 45 mm	12	M 24 x 1,5 16 S	1049385 Verschluss- schraube  Screw Plug
	1043694	(73673*)			12	M 22 x 1,5 15 L	
	1064842	(480220*) (441780*)	Kupplungs- muffe für Schottplat- tenmontage  Female Coupling for Bulkhead	4 Ø RD  Ø RD 42 x 2	12	M 22 x 1,5 15 L L: 27 mm	441836 Verschluss- mutter  Lock Nut
					739509	-	
	678321	-	Kupplungs- stecker  Coupling Male	4 Ø AD  Ø OD 48 mm	12	M 22 x 1,5 15 L	441837 Verschluss- schraube  Screw Plug
	661036	-			16	M 26 x 1,5 18 L	
	441834	-	Kupplungs- stecker für Schottplatten- montage  Coupling Male for Bulkhead	4 Ø AD  Ø OD 48 mm	12	M 22 x 1,5 15 L L: 27 mm	441837 Verschluss- schraube  Screw Plug
	661034	-			16	M 26 x 1,5 18 L L: 27 mm	

\*Abweichende Maße der ersetzten Kupplungen erhalten Sie auf Anfrage. | Please find divergent dimensions of replaced couplings on request.

Passende Kennzeichnungsringe erhalten Sie auf Anfrage. | Suitable Identification Rings on request.

# Ersatzteile Hydraulik

## Spare Parts Hydraulics



Darstellung Illustration	Bauer-Best.Nr. Bauer Item No.	Ehemalige Bauer-Best.Nr. Previous Bauer Item No.	Bezeichnung Description	Baugröße Construction Size	Nenn- weite Size	Anschluss Connection	Bauer-Best.Nr. Bauer Item No.
							Bezeichnung Description
	1411846	(480221*) (1064847*)	Kupplungs- stecker Coupling Male	4 Ø AD Ø OD 48,5 mm	12	M 22 x 1,5 15 L	97002 Verschluss- schraube Screw Plug
	1050713	(262891*) (201929*)	Kupplungs- muffe Coupling Female		16	M 30 x 2 20 S	1052333 Verschluss- mutter Lock Nut
	1050640	(63748*) (24074*)			20	M 36 x 2 25 S	
	1050711	(269116*)			25	M 42 x 2 30 S	
	1065302	(26935*)	20	M 30 x 2 22 L			
	1050639	(412749*)	Kupplungs- muffe für Schottplat- tenmontage Female Coupling for Bulkhead	6 Ø RD Ø RD 48 x 3	25	M 42 x 2 30 S L: 40 mm	1052333 Verschluss- mutter Lock Nut
	1050712	(249323*)			20	M 30 x 2 22 L L: 34 mm	
	1052335	(666996*)			25	M 36 x 2 28 L L: 34 mm	
	1057748	-	Kupplungs- muffe Coupling Female		20	1"	

\*Abweichende Maße der ersetzten Kupplungen erhalten Sie auf Anfrage. | Please find divergent dimensions of replaced couplings on request.

Passende Kennzeichnungsringe erhalten Sie auf Anfrage. | Suitable Identification Rings on request.

# Ersatzteile Hydraulik

## Spare Parts Hydraulics

Darstellung Illustration	Bauer-Best.Nr. Bauer Item No.	Ehemalige Bauer-Best.Nr. Previous Bauer Item No.	Bezeichnung Description	Baugröße Construction Size	Nenn- weite Size	Anschluss Connection	Bauer-Best.Nr. Bauer Item No.
							Bezeichnung Description
	1207864	(675482*)			16	M 30 x 2 20 S	
	1207830	(675481*)			20	M 36 x 2 25 S	
	1207829	(663819*)			25	M 42 x 2 30 S	
	1207825	(36090*) (1043697*)			16	M 26 x 1,5 18 L	
	1207828	(19070*) (1043698*)			20	M 30 x 2 22 L	
	1207861	(261193*) (1043713*)			25	M 36 x 2 28 L	
	1063338	-	Kupplungs- muffe Coupling Female	6 Ø RD 54 x 4	25	1"	20945 Verschluss- mutter Lock Nut
	1063339	-			25	1"	
	1207829	(904173*)			25	M 42 x 2 30 S	
	1207644	(27536*) (1050575*) (209485*)	Kupplungs- stecker Coupling Male	6 Ø AD 55 mm	16	M 30 x 2 20 S	1052334 Verschluss- schraube Screw Plug
	1050574 Ersatzmat.Nr. 1207642	(26874*) (24134*)			20	M 36 x 2 25 S	
	1207643	(234622*) (1050577*)			25	M 42 x 2 30 S	
	1207608	(27010*) (1050576*)			20	M 30 x 2 22 L	
	1207610	(666957*) (1064848*)	25	M 36 x 2 28 L			

\*Abweichende Maße der ersetzten Kupplungen erhalten Sie auf Anfrage. | Please find divergent dimensions of replaced couplings on request.

Passende Kennzeichnungsringe erhalten Sie auf Anfrage. | Suitable Identification Rings on request.



## **Ihre Experten für Hydraulikschläuche** *Your Specialists in Hydraulic Hoses*

Wir verfügen über ein breites Angebot an Hydraulikschläuchen:

- Saugschläuche von NW 25 bis NW 100
- 2-lagen Niederdruckschläuche von NW 6 bis NW 75
- 4-lagen Hochdruckschläuche bis NW 25
- R15 Hochdruckschläuche 420 bar von NW 32 bis NW 50, Länge bis 120 m
- Temperaturbereiche von -55 °C bis 150 °C

*We offer a wide range of hydraulic hoses:*

- *Suction hoses NS 25 to NS 100*
- *Double layer low pressure hoses NS 6 to NS 75*
- *Four layer high pressure hoses until NS 25*
- *R15 high-pressure hoses 420 bar from NS 32 to NW 50, length up to 120 m*
- *Temperature range -55 °C to 150 °C*

Sonderschläuche auf Anfrage  
*Special hoses on request*

Um den Bestellvorgang zu beschleunigen, finden Sie die Original-Bauer-Materialnummer auf der Einpresshülse.  
*You find the original Bauer material number on the press-in sleeve to accelerate the order process.*

# Ersatzteile Hydraulik

## Spare Parts Hydraulics

Darstellung Illustration	Bauer-Best.Nr. Bauer Item No.	Ehemalige Bauer-Best.Nr. Previous Bauer Item No.	Bezeichnung Description	Baugröße Construction Size	Nenn- weite Size	Anschluss Connection	Bauer-Best.Nr. Bauer Item No.
							Bezeichnung Description
	1207605	(1057749*)	Kupplungs- stecker  Coupling Male	6 Ø AD  Ø OD 55 mm	20	1"	1052334 Verschluss- schraube  Screw Plug
	1141395	(364923*)			25	M 42 x 2 30 S	
	675484	-	Kupplungs- stecker  Coupling Male	6 Ø AD  Ø OD 64 mm	16	M 30 x 2 20 S	20948 Verschluss- schraube  Screw Plug
	675483	-			20	M 36 x 2 25 S	
	904174	(663820*)			25	M 42 x 2 30 S	
	1207746	(36091*) (1043714*)			16	M 26 x 1,5 18 L	
	1207761	(246034*) (1043715*)			20	M 30 x 2 22 L	
	1207762	(277661*) (1043733*)			25	M 36 x 2 28 L	
	1207766	(784321*)	KS für Schott- plattenmon- tage  ... for Male Bulkhead	25	M 36 x 2 28 L L: 43 mm		
	1063331	-	Kupplungs- stecker  Coupling Male	25	1"		

\*Abweichende Maße der ersetzten Kupplungen erhalten Sie auf Anfrage. | Please find divergent dimensions of replaced couplings on request.

Passende Kennzeichnungsringe erhalten Sie auf Anfrage. | Suitable Identification Rings on request.



# Ersatzteile Hydraulik

## Spare Parts Hydraulics

Darstellung Illustration	Bauer-Best.Nr. Bauer Item No	Ehemalige Bauer-Best.Nr. Previous Bauer Item No.	Bezeichnung Description	Baugröße Construction Size	Nenn- weite Size	Anschluss Connection	Bauer-Best.Nr. Bauer Item No.
							Bezeichnung Description
	784320	-	Kupplungs- stecker Coupling Male	6 Ø AD Ø OD 64 mm	25	M 42 x 2 30 S	20948 Verschluss- schraube Screw Plug
	1065135	(248291*)	Kupplungs- muffe Coupling Female		25	M 42 x 2 30 S	
	1065138	(228516*)			32	M 52 x 2 38 S	
	1065159	(27538*)	Kupplungs- muffe für Schottplatten- montage Female- Coupling for Bulkhead	8 Ø RD Ø RD 70 x 3	25	M 42 x 2 30 S L: 40 mm	44156 Verschluss- mutter Lock Nut
	1065160	(44154*)			32	M 52 x 2 38 S L: 40 mm	
	390534	-			32	M 45 x 2 35 L L: 36 mm	
	515630	-			40	M 52 x 2 42 L L: 36 mm	
	1064286	-			32	1 1/4"	
	1086952	-	Kupplungs- muffe Coupling Female		32	1 1/4"	
	1207821	(228758*)		8 Ø RD Ø RD 79 x 4	32	M 52 x 2 38 S	21056 Verschluss- mutter Lock Nut

\*Abweichende Maße der ersetzten Kupplungen erhalten Sie auf Anfrage. | Please find divergent dimensions of replaced couplings on request.

Passende Kennzeichnungsringe erhalten Sie auf Anfrage. | Suitable Identification Rings on request.

# Ersatzteile Hydraulik

## Spare Parts Hydraulics

Darstellung Illustration	Bauer-Best.Nr. Bauer Item No.	Ehemalige Bauer-Best.Nr. Previous Bauer Item No.	Bezeichnung Description	Baugröße Construction Size	Nenn- weite Size	Anschluss Connection	Bauer-Best.Nr. Bauer Item No.
							Bezeichnung Description
	1054671	-	Kupplungs- muffe Coupling Female	8 Ø RD Ø RD 79 x 4	32	1 1/4"	21056 Verschluss- mutter Lock Nut
	1054673	-					
	1065187	(44160*)	Kupplungs- stecker Coupling Male	8 Ø AD Ø OD 80 mm	32	M 52 x 2 38 S	833211 Verschluss- schraube Screw Plug
	1207650	(27539*) (833100*)					
	1195428	(390533*)	Kupplg.stecker für Schottplat- tenmontage Coupling Male for Bulkhead	8 Ø AD Ø OD 80 mm	32	M 45 x 2 35 L L: 40 mm	63744 Verschluss- schraube Screw Plug
	389850	-					
	1207743	(784319*)	KS für Schott- plattenmon- tage ... for Bulkhead	8 Ø AD Ø OD 90 mm	32	M 52 x 2 38 S L: 53 mm	20955 Verschluss- schraube Screw Plug

\*Abweichende Maße der ersetzten Kupplungen erhalten Sie auf Anfrage. | Please find divergent dimensions of replaced couplings on request.

Passende Kennzeichnungsringe erhalten Sie auf Anfrage. | Suitable Identification Rings on request.



# Ersatzteile Hydraulik

## Spare Parts Hydraulics

Darstellung Illustration	Bauer-Best.Nr. Bauer Item No.	Ehemalige Bauer-Best.Nr. Previous Bauer Item No.	Bezeichnung Description	Baugröße Construction Size	Nenn- weite Size	Anschluss Connection	Bauer-Best.Nr. Bauer Item No.  Bezeichnung Description
	1054610	-	Kupplungs- stecker  Coupling Male	8 Ø AD  Ø OD 90 mm	32	1 1/4"	20955 Verschluss- schraube Screw Plug 1099345 Sicherungs- splint m. Seil  Cotter Pin with Rope
	1063216	-			32	1 1/4"	
	1054609	(228759*) (1297589*)			32	M 52 x 2 38 S	
 Ø 9,5	393057	-	Montagewerkzeug für Hydr. Kupplungen Baugröße 8 und 10 Assembly Tool for Hyd. Coupling Size 8 and 10				
	1338466	(1045767*)	Kupplungs- stecker  Coupling Male	10 Ø RD  Ø RD 80 x 4	38	1 1/2"	1018827 Verschluss- mutter  Lock Nut
	1338502	-			38	1 1/2"	
	1017006	-			38	M 52 x 2 38 S	
	1045801	-	Kupplungs- muffe  Coupling Female	10 Ø AD  Ø OD 90 mm	38	1 1/2"	1018828 Verschluss- schraube  Screw Plug
	1017008	-			38	M 52 x 2 38 S	

\*Abweichende Maße der ersetzten Kupplungen erhalten Sie auf Anfrage. | Please find divergent dimensions of replaced couplings on request.

Passende Kennzeichnungsringe erhalten Sie auf Anfrage. | Suitable Identification Rings on request.

# Ersatzteile Hydraulik

## Spare Parts Hydraulics

Steckkupplungen   Plug-in Couplings							
Darstellung Illustration	Bauer-Best.Nr. Bauer Item No.	Ehemalige Bauer-Best.Nr. Previous Bauer Item No.	Bezeichnung Description	Baugröße Construction Size	Nenn- weite Size	Anschluss Connection	Bauer-Best.Nr. Bauer Item No.  Bezeichnung Description
	1064810	(23014*)	Steckkupplungs- muffe Schott- platteneinbau Plug-In Coupling Female for Bulk- head	2 Ø AD Ø OD 32 mm	6	M 18 x 1,5 10 S L: 27 mm	20946 Staubstecker Dust Plug
	1049934	(38104*)	Steckkupplungs- muffe Plug-In Coupling Female		8	M 20 x 1,5 12 S	
	1049850	(64304*)	Steckkupplungs- stecker Plug-In Coupling Male	2 SW 22	8	M 16 x 1,5 10 L	1049940 Staubmuffe Dust Sleeve
	1049845	(23015*)	Steckkupplungs- muffe Plug-In Coupling Female	3 Ø AD Ø OD 38 mm	10	M 18 x 1,5 12 L	24541 Staubstecker Dust Plug
	1049841	(36083*)	Steckkupplungs- muffe Schott- platteneinbau Plug-In Coupling Female for Bulk- head		10	M 18 x 1,5 12 L L: 30 mm	
	1049573	(36089*)	Steckkupplungs- stecker Plug-In Coupling Male	3 SW 27	10	M 18 x 1,5 12 L	23604 Staubmuffe Dust Sleeve
	1049572	(24403*)	Steckkupplungs- stecker Schott- platteneinbau Plug-In Coupling Male for Bulkhead		10	M 18 x 1,5 12 L L: 26 mm	

\*Abweichende Maße der ersetzten Kupplungen erhalten Sie auf Anfrage. | Please find divergent dimensions of replaced couplings on request.

Passende Kennzeichnungsringe erhalten Sie auf Anfrage. | Suitable Identification Rings on request.



## Bauer Rebuilt

Profitieren Sie von unserer Erfahrung, um den größten Nutzen aus Ihrem Gerät zu ziehen!

Was ist Rebuilt?

- **Complete Rebuilt:** Generalüberholung Ihres Gerätes für ein zweites Maschinenleben
- **Power Train Rebuilt:** Testen, überholen und optimieren des Antriebsstranges
- **Hydraulic Rebuilt:** Überholung der hydraulisch relevanten Komponenten
- **Individual Rebuilt:** Individuelle Überholung oder Reparatur des gesamten Gerätes oder einzelner Komponenten

Vorteile für Sie:

- Reduzierung der Kosten infolge der Minimierung von Ausfallzeiten
- Instandsetzung auf höchstem Niveau
- Verlängerung der Lebenszeit
- umweltfreundliches Agieren

Use our experience to get the greatest benefit out of your machine!

What's Rebuilt?

- **Complete Rebuilt:** General overhauling to give your machine a second live.
- **Power Train Rebuilt:** Testing, overhauling and optimizing of the power train
- **Hydraulic Rebuilt:** Overhauling of all hydraulic components
- **Individual Rebuilt:** Individual overhauling or repair of the whole machine or single components



Benefits for you:

- minimizing of downtime by reducing costs
- repairs at highest level
- expanding life cycle
- staying environmentally friendly

# Ersatzteile Hydraulik

## Spare Parts Hydraulics













Universalfansch   Universal Flange			
Darstellung Illustration	Bauer-Best.Nr. Bauer Item No.	Bezeichnung Description	Anschluss Connection
	1375528	SAE Universalfansch 6000 PSI 1" Universal Flange	M 36 x 2 / 25 S
	94618	SAE Universalfansch 6000 PSI 1 1/4" Universal Flange	M 42 x 2 / 30 S
	87381	SAE Universalfansch 6000 PSI 1 1/4" Universal Flange	M 52 x 2 / 38 S
	45633	Zyl. Schraube mit Innensechskant Cylinder Screw with Hexagon	M 14 x 90
	23452	Zyl. Schraube mit Innensechskant Cylinder Screw with Hexagon	M 14 x 130



# Ersatzteile Hydraulik

## Spare Parts Hydraulics

### Kugelhähne | Ball Valves

Darstellung Illustration	Bauer-Best.Nr. Bauer Item No.	Bezeichnung Description	Passende Dichtung Fitting Sealing
	224606	Kugelhahn SAE 1 1/4" – Plattenmontage Ball Valve – Plate Mounting	57449
	224607	Kugelhahn SAE 1 1/4" – Schlauchmontage Ball Valve – Hose Mounting	57449
	394186	Anschlagscheibe SW 14 – für   for 1 1/4" Guide Washer	-
	633476	Griff gekröpft – für   for SW 14 – 1 1/4" Offset Handles	-
	1063369	Distanzstück für Kugelhahn SW 14 Distance Piece for Ball Valve	-
	224608	Kugelhahn 1 1/2" – Plattenmontage Ball Valve – Plate Mounting	72736
	224609	Kugelhahn 1 1/2" – Schlauchmontage Ball Valve – Hose Mounting	72736
	394187	Anschlagscheibe SW 17 – für   for 1 1/2" Guide Washer	-
	603149	Griff gekröpft – für   for SW 17 – 1 1/2" Offset Handles	-
	1065347	Distanzstück für Kugelhahn SW 17 Distance Piece for Ball Valve	-
	260632	Blockkugelhahn für Druckausgleich Stop-Cock for Pressure Balance	-





## Zubehör Accessories



---

<b>Zubehör für Geräte</b> <b>Accessories for Rigs</b>	<b>286 - 297</b>
· Ersatzteile für Fahrer­kabi­nen Spare Parts for Driver Cabins	286 - 293
· Auf­rit­te und Auf­stiegs­lei­tern Steps and Ladders	294
· Sonnensegel für Fahrer­kabi­nen Sun Shades for Driver Cabins	295
· Brandschutz · Erste Hilfe Fire Safety · First Aid	296
· HSE-Aufkleber HSE Stickers	297 - 301

# Zubehör für Geräte Accessories for RIGS

## Ersatzteile für Fahrerkabinen | Spare Parts for Driver Cabins

Schiebetürkabine F3 | Sliding Door Cabin

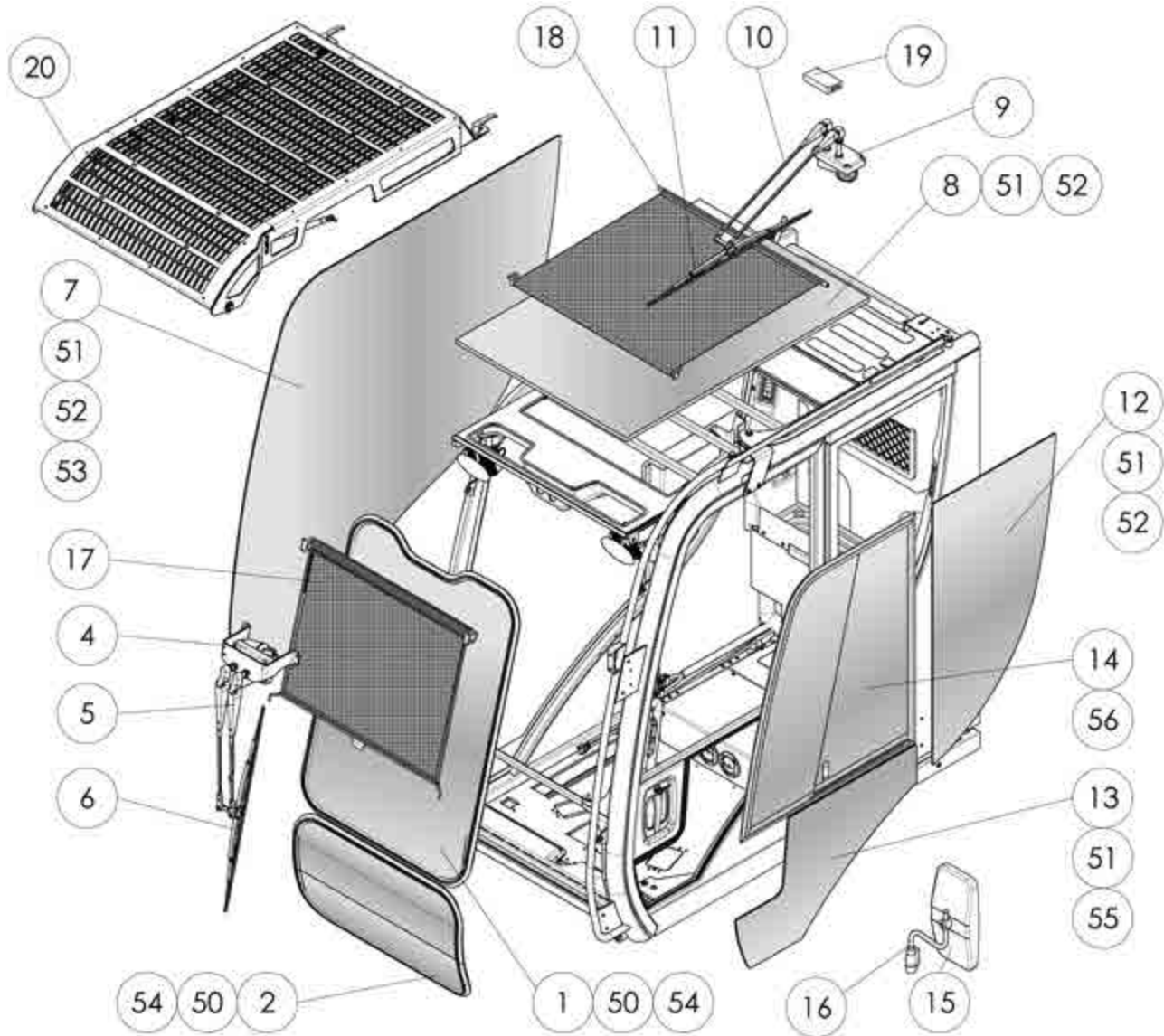

Darstellung Illustration	Bauer-Best.Nr. Bauer Item No.	Bezeichnung Description
1	1145473	Fensterscheibe Front, oben   <a href="#">Window Pane Front, Top</a>
2	1145474	Fensterscheibe Front, unten   <a href="#">Window Pane Front, Bottom</a>
4	1343025	Wischemotor-Austauschsatz Front (bis Kabinenseriennummer 6725498) <a href="#">Wiper Motor Replacement Kit Front (Cabin Serial Number 6725498 and Down)</a>
4	1342974	Wischemotor Front (ab Kabinenseriennummer 6725499) <a href="#">Wiper Motor Front (Cabin Serial Number 6725499 and Up)</a>

# Zubehör für Geräte

## Accessories for RIGS



Position Position	Bauer-Best.Nr. Bauer Item No.	Bezeichnung Description
5	1302215	Wischerarm Front 575 mm (bis Kabinenseriennummer 6725498) <a href="#">Wiper Arm Front (Cabin Serial Number 6725498 and Down)</a>
5	1342975	Wischerarm Front 560 mm (ab Kabinenseriennummer 6725499) <a href="#">Wiper Arm Front (Cabin Serial Number 6725499 and Up)</a>
6	1302216	Wischerblatt 800 mm   <a href="#">Wiper Blade</a>
7	1145478	Fensterscheibe rechts   <a href="#">Window Pane Right</a>
7	1311365	Fensterscheibe rechts mit Fach   <a href="#">Window Pane Right with Pocket</a>
8	1145475	Fensterscheibe Dach   <a href="#">Window Pane Roof</a>
9	1302220	Wischermotor Dach   <a href="#">Wiper Motor Roof</a>
10	1399838	Wischerarm Dach 750 mm   <a href="#">Wiper Arm Roof</a>
11	1302216	Wischerblatt 800 mm   <a href="#">Wiper Blade</a>
12	1145477	Fensterscheibe links, hinten   <a href="#">Window Pane Left, Rear</a>
13	1145481	Fensterscheibe Tür, unten   <a href="#">Window Pane Door, Bottom</a>
14	1368249	Schiebefenster Einbausatz kpl   <a href="#">Sliding Window Assembly Set cpl.</a>
15	118409	Außenspiegel 375 x 175 mm   <a href="#">Side Mirror</a>
16	1302222	Spiegelhalter 16 mm   <a href="#">Mirror Holder</a>
17	1302233	Sonnenrollo Front   <a href="#">Roll-up Curtain Front</a>
18	1302231	Sonnenrollo Dach   <a href="#">Roll-up Curtain Roof</a>
19	1302193	Spannungswandler 24 V - 12 V, 10 A   <a href="#">Voltage Converter</a>
20	1291171	Schutzgitter Dach mit Gasfeder kpl.   <a href="#">Protective Grating Roof with Gas Spring cpl.</a>
50	1307148	Servicekit für Kederscheibe   <a href="#">Service Kit for Keder Glas</a>
51	1273346	Scheibenklebstoff-Set   <a href="#">Window Adhesive-Set</a>
52	1307022	Zellgummiprofil 3 x 5 mm, 10 m   <a href="#">Foam Rubber</a>
54	30808	Sekundenkleber 5 g   <a href="#">Superglue</a>
55	1307135	Zellgummiprofil 5 x 5 mm, 3 m   <a href="#">Foam Rubber</a>
56	1307149	Klebekit für Alu-Pulver-Blech   <a href="#">Glue Kit for Alu-Powder-Metal Sheet</a>

# Zubehör für Geräte Accessories for RIGS

Schiebetürkabine K8 | Sliding Door Cabin

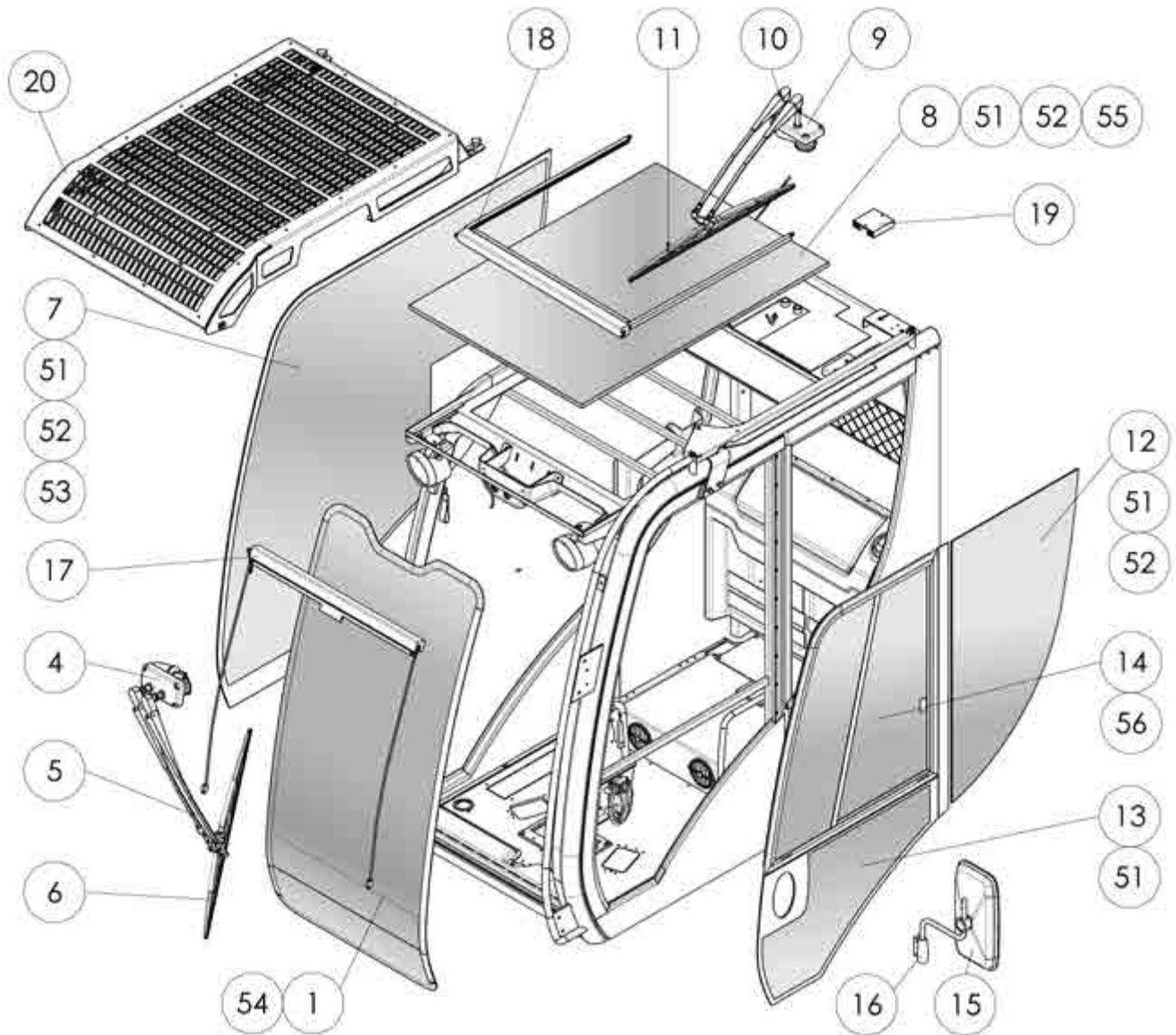

Darstellung Illustration	Bauer-Best.Nr. Bauer Item No.	Bezeichnung Description
1	919359	Ersatzkit Fensterscheibe Front   <a href="#">Replacement Kit Window Pane Front</a>
4	674103	Wischermotor Front   <a href="#">Wiper Motor Front</a>
5	1133759	Wischerarm Front 600 mm   <a href="#">Wiper Arm Front</a>
6	692814	Wischerblatt 800 mm   <a href="#">Wiper Blade</a>
7	1022575	Fensterscheibe rechts   <a href="#">Window Pane Right</a>

# Zubehör für Geräte

## Accessories for RIGS



Position Position	Bauer-Best.Nr. Bauer Item No.	Bezeichnung Description
8	1015065	Fensterscheibe Dach   <a href="#">Window Pane Roof</a>
9	933121	Wischermotor Dach   <a href="#">Wiper Motor Roof</a>
10	692872	Wischerarm Dach   <a href="#">Wiper Arm Roof</a>
11	692814	Wischerblatt 800 mm   <a href="#">Wiper Blade</a>
12	1022577	Fensterscheibe links, hinten   <a href="#">Window Pane Door, Rear</a>
13	1007989	Fensterscheibe Tür, oben   <a href="#">Window Pane Door, Bottom</a>
14	1007990	Fensterscheibe Tür, oben   <a href="#">Window Pane Door, Top</a>
15	753697	Außenspiegel 355 x 165 mm   <a href="#">Side Mirror</a>
15	1118409	Außenspiegel 375 x 175 mm   <a href="#">Side Mirror</a>
16	1302222	Spiegelhalter 16 mm   <a href="#">Mirror Holder</a>
17	722274	Sonnenrollo Front   <a href="#">Roll-up Curtain Front</a>
18	909304	Sonnenrollo Dach   <a href="#">Roll-up Curtain Roof</a>
19	695712	Spannungswandler 24 V - 12 V, 2 A   <a href="#">Voltage Converter</a>
20	1147708	Schutzgitter Dach mit Stange   <a href="#">Protective Grating Roof with Support Rod</a>
20	1133754	Schutzgitter Dach mit Gasfeder kpl.   <a href="#">Protective Grating Roof with Gas Spring cpl.</a>
51	1273346	Scheibenklebstoff-Set   <a href="#">Window Adhesive-Set</a>
52	1253717	Moosgummiband 3 x 8 mm, 25 m   <a href="#">Foam Rubber Band</a>
53	1090777	Scheibenklebstoff-Kartusche   <a href="#">Window Adhesive-Set</a>
54	30808	Sekundenkleber 5 g   <a href="#">Superglue</a>
55	930176	Moosgummiband 7,5 x 8 mm, 10 m   <a href="#">Foam Rubber Band</a>
56	1307149	Klebekit für Alu-Pulver-Blech   <a href="#">Glue Kit for Alu-Powder-Metal Sheet</a>

# Zubehör für Geräte Accessories for RIGS

## Schwingtürkabine B2 | Swinging Door Cabin

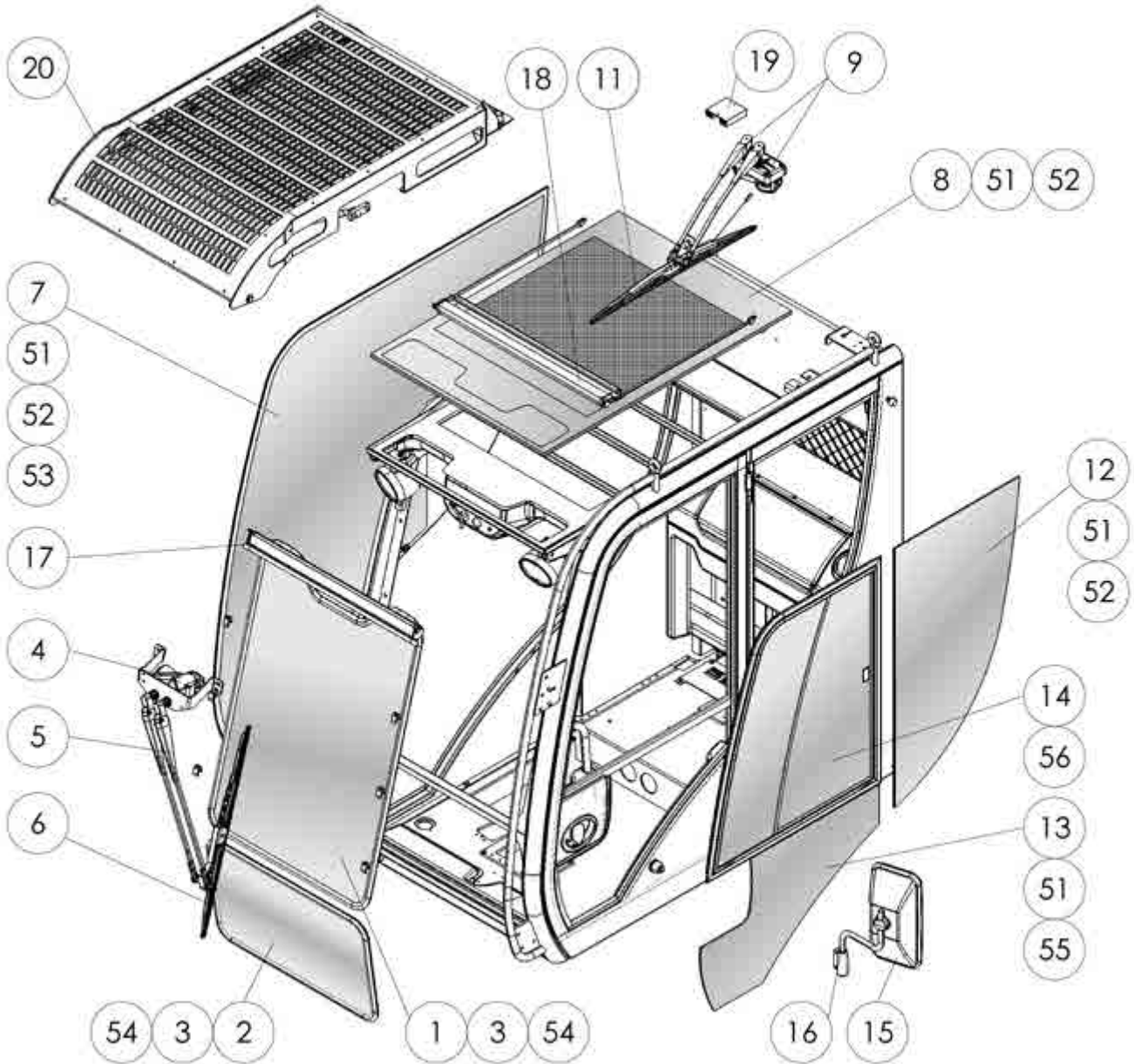

Darstellung Illustration	Bauer-Best.Nr. Bauer Item No.	Bezeichnung Description
1	1200098	Fensterscheibe Front, oben   <a href="#">Window Pane Front, Top</a>
2	1200094	Fensterscheibe Front, unten   <a href="#">Window Pane Front, Bottom</a>
3	1200004	Scheibengummi Frontscheibe   <a href="#">Rubber Seal Front Window</a>
4	1197481	Wischermotor Front   <a href="#">Wiper Motor Front</a>
5	1200235	Wischerarm Front 600 mm   <a href="#">Wiper Arm Front</a>

# Zubehör für Geräte

## Accessories for RIGS



Position Position	Bauer-Best.Nr. Bauer Item No.	Bezeichnung Description
6	692814	Wischerblatt 800 mm   <a href="#">Wiper Blade</a>
7	1200139	Fensterscheibe rechts   <a href="#">Window Pane Right</a>
8	1015065	Fensterscheibe Dach   <a href="#">Window Pane Roof</a>
9	1200237	Dachscheibenwischer kpl.   <a href="#">Wiper Motor Roof cpl.</a>
11	692814	Wischerblatt 800 mm   <a href="#">Wiper Blade</a>
12	1200095	Fensterscheibe links, hinten   <a href="#">Window Pane Left, Rear</a>
13	1200100	Fensterscheibe Tür, unten   <a href="#">Window Pane Door, Bottom</a>
14	1007990	Fensterscheibe Tür, oben   <a href="#">Window Pane Door, Top</a>
15	1118409	Außenspiegel 375 x 175 mm   <a href="#">Side Mirror</a>
16	1200233	Spiegelhalter 16 mm   <a href="#">Mirror Holder</a>
17	1300483	Sonnenrollo Front   <a href="#">Roll-up Curtain Front</a>
18	1300484	Sonnenrollo Dach   <a href="#">Roll-up Curtain Roof</a>
19	1200255	Spannungswandler 24 V - 12 V, 10 A   <a href="#">Voltage Converter</a>
20	1019352	Schutzgitter Dach mit Stange   <a href="#">Protective Grating Roof with Support Rod</a>
20	1192014	Schutzgitter Dach mit Gasfeder kpl.   <a href="#">Protective Grating Roof with Gas Spring cpl.</a>
51	1273346	Scheibenklebstoff-Set   <a href="#">Window Adhesive-Set</a>
52	1307022	Zellgummiprofil 3 x 5 mm, 10 m   <a href="#">Foam Rubber</a>
53	1090777	Scheibenklebstoff-Kartusche   <a href="#">Window Adhesive-Set</a>
54	30808	Sekundenkleber 5 g   <a href="#">Superglue</a>
55	930176	Moosgummiband 7,5 x 8 mm, 10 m   <a href="#">Foam Rubber Band</a>
56	1307149	Klebekit für Alu-Pulver-Blech   <a href="#">Glue Kit for Alu-Powder-Metal Sheet</a>

# Zubehör für Geräte Accessories for RIGS

## Schwingtürkabine S1 | Swinging Door Cabin

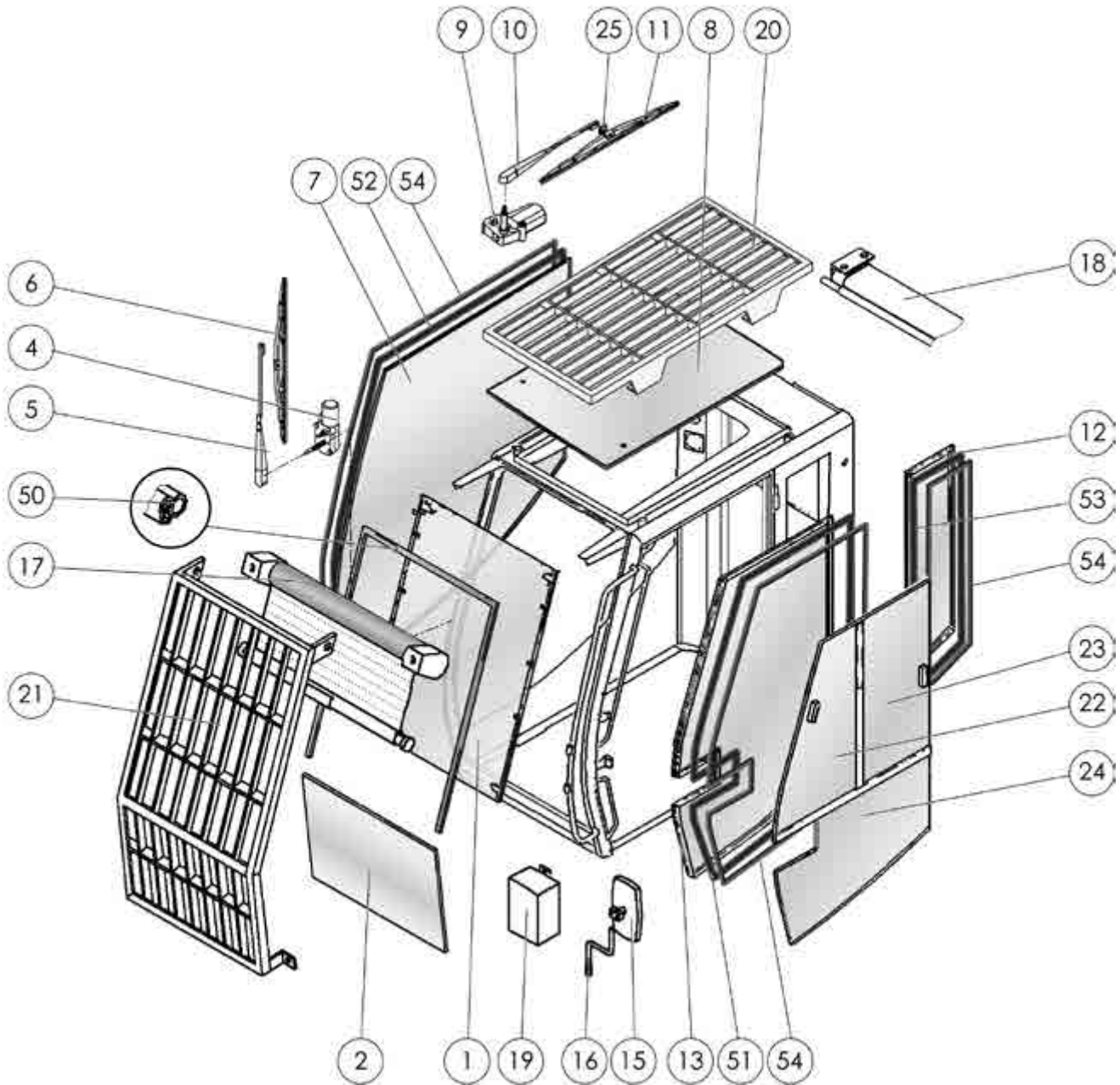

Darstellung Illustration	Bauer-Best.Nr. Bauer Item No.	Bezeichnung Description
1	411484	Fensterscheibe Front, getönt (oben)   Window Pane Front, Tinted (Top)
1	421677	Fensterscheibe Front, Panzerglas (oben)   Window Pane Front, Bullet Proof (Top)
2	430989	Fensterscheibe Front, klar (unten)   Window Pane Front, Clear (Bottom)
2	395590	Fensterscheibe Front, getönt (unten)   Window Pane Front, Tinted (Bottom)
4	398263	Wischermotor Front   Wiper Motor Front

# Zubehör für Geräte

## Accessories for RIGS









Position Position	Bauer-Best.Nr. Bauer Item No.	Bezeichnung Description
5	418425	Wischerarm Front 450 mm   <a href="#">Wiper Arm Front</a>
6	408108	Wischerblatt 500 mm   <a href="#">Wiper Blade</a>
7	465530	Fensterscheibe rechts, klar   <a href="#">Window Pane Right, Clear</a>
8	380744	Fensterscheibe Dach, parsolgrün   <a href="#">Window Pane Roof, Green Tinted</a>
8	410360	Fensterscheibe Dach, Panzerglas   <a href="#">Window Pane Roof, Bulletproof Glass</a>
9	361469	Wischermotor Dach für Panzerglas-Scheibe   <a href="#">Wiper Motor Roof for Bulletproof Glass</a>
9	380746	Wischermotor Dach für Normalscheibe   <a href="#">Wiper Motor Roof for Standard Glass</a>
10	380541	Wischerarm 375 mm Dach   <a href="#">Wiper Arm Roof</a>
11	407549	Wischerblatt 400 mm   <a href="#">Wiper Blade</a>
12	794484	Fensterscheibe links hinten, klar   <a href="#">Window Pane Left Rear, Clear</a>
12	380682	Fensterscheibe links hinten, getönt   <a href="#">Window Pane Left Rear, Tinted</a>
13	422906	Fensterscheibe Tür, einteilig, klar   <a href="#">Window Pane Door, Single Piece, Clear</a>
13	380681	Fensterscheibe Tür, einteilig, getönt   <a href="#">Window Pane Door, Single Piece, Tinted</a>
15	378689	Außenspiegel 55 x 165 mm   <a href="#">Side Mirror</a>
15	204159	Außenspiegel 225 x 145 mm   <a href="#">Side Mirror</a>
16	592919	Spiegelhalter 16 mm   <a href="#">Mirror Holder</a>
16	204160	Spiegelhalter 10 mm   <a href="#">Mirror Holder</a>
17	430875	Sonnenrollo Front   <a href="#">Roll-up Curtain Front</a>
18	408546	Sonnenrollo Dach   <a href="#">Roll-up Curtain Roof</a>
19	408998	Spannungswandler 24 V - 12 V, 10 A   <a href="#">Voltage Converter</a>
20	621832	Schutzgitter Dach   <a href="#">Protective Grating Roof</a>
21	423162	Schutzgitter Front   <a href="#">Protective Grating Front</a>
22	754137	Fensterscheibe Tür, vorne   <a href="#">Window Pane Door, Front</a>
23	711655	Fensterscheibe Tür, hinten   <a href="#">Window Pane Door, Rear</a>
24	758549	Fensterscheibe Tür, unten   <a href="#">Window Pane Door, Bottom</a>
25	407550	Adapter Wischerarm/-blatt   <a href="#">Adapter Wiper Arm/Wiper Blade</a>
50	1014690	Dichtprofil für Frontscheibe   <a href="#">Sealing Profile for Front Window</a>
51	380685	Dichtprofil für Türscheibe   <a href="#">Sealing Profile for Door Window</a>
52	408434	Dichtprofil für Seitenscheibe rechts   <a href="#">Sealing Profile for Side Window Right</a>
53	380688	Dichtprofil für Seitenscheibe links   <a href="#">Sealing Profile for Side Window Left</a>
54	766407	Füllerprofil für Scheibendichtprofil   <a href="#">Filler Profile for Window Seal</a>

# Zubehör für Geräte

## Accessories for RIGS

### Auftritte und Aufstiegsleitern | Steps and Ladders

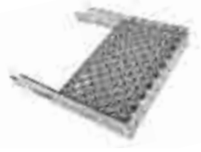
Darstellung Illustration	Bauer-Best.Nr. Bauer Item No.	Bezeichnung Description	Länge (mm) Length (mm)	Breite (mm) Width (mm)	Höhe (mm) Height (mm)
	453917	Aufstiegsleiter Climbing Ladder	457	396	310
	929461	Aufstieg Tread	545	240	207
	721779	Aufstieg Tread	631	350	185
	749039	Aufstieg Tread	560	350	185
	177579	Aufstieg Tread	320	200	133
	374668	Aufstieg Tread	355	290	60
	520917	Aufstieg Tread	356	293	70

# Zubehör für Geräte

## Accessories for RIGS



### Sonnensegel für Fahrerkabinen | Sun Shades for Driver Cabins



Sonnensegel ‚Klein‘ 2087,5 x 750 mm inkl. Verbindungselement   Sun Shade "Small" incl. Fastener		
Darstellung Illustration	Bauer-Best.Nr. Bauer Item No.	Bezeichnung Description
	739050	Sonnensegel KFB Kabine Sun Shade KFB Cabin
	758045	Sonnensegel Kamm Kabine Sun Shade Kamm Cabin
	757979	Sonnensegel SEN Kabine Sun Shade SEN Cabin

Wetterschutzdach   Weatherproof Shield		
Darstellung Illustration	Bauer-Best.Nr. Bauer Item No.	Bezeichnung Description
	1298614	Wetterschutzdach FM Kabine kpl. Weatherproof Shield FM Cabin cpl.

Bitte bei Bestellung die Seriennummer des Gerätes angeben!  
Please specify the serial number of the rig when ordering!

# Zubehör für Geräte Accessories for RIGS

## Brandschutz • Erste Hilfe | Fire Safety • First Aid

Darstellung Illustration	Bauer-Best.Nr. Bauer Item No.	Bezeichnung Description
	279644	Feuerlöscher Fire Extinguisher
	940870	Feuerlöscherhalter Holder Fire Extinguisher
	208554	Verbandkasten First Aid Box













# Zubehör für Geräte

## Accessories for RIGS











### HSE Aufkleber | HSE Sticker

Darstellung Illustration	Bauer-Best.Nr. Bauer Item No.	Bezeichnung Description
	469947	„Betriebsspannung 24 V“ 30 x 60 mm “Reference to operating voltage 24 V”
	468967	„Aufbewahrungsort der Betriebsanleitung/Bedienungsanleitung“ Ø 100 mm “Location of the instruction manual/operating instructions”
	470081	„Gebrauchsanweisung beachten“ Ø 100 mm “Observe instruction manual”
	488077	„Gehör- und Kopfschutz“ Ø 100 mm “Wear head and ear protection”
	469944	„Hinweis auf Trennschalter für die Batterie“ Ø 30 mm “Reference to battery circuit breaker”
	458867	„Auffanggurt tragen“ Ø 100 mm “Wear safety harness”
	469948	„Herausschleudernde Teile! Warnungshinweise beachten!“ 30 x 70 mm “Ejecting parts! Observe maintenance instructions!”
	469972	„Schnittgefahr! Gefahr von herausspritzendem Medium!“ 100 x 100 mm “Cutting hazard! Danger of spurting medium!”
	469967	„Quetschgefahr!“ 100 x 100 mm “Danger of getting crushed!”
	469802	„Quetschgefahr, Schergefahr!“ 100 x 100 mm “Danger of getting crushed, danger of getting cut!”

# Zubehör für Geräte

## Accessories for RIGS

Darstellung Illustration	Bauer-Best.Nr. Bauer Item No.	Bezeichnung Description
	470076	„Handverletzung“ 100 x 100 mm “Hand injury”
	758678	„Platzende Rohrleitung“ 100 x 100 mm “Bursting Pipeline”
	468971	„Absturzgefahr!“ 100 x 100 mm “Risk of falling!”
	470004	„Schergefahr! Warnung vor rotierendem Lüfterrad!“ 100 x 100 mm “Danger of getting cut! Rotating fan wheel warning!”
	470074	„Einzugsgefahr!“ 100 x 100 mm “Entanglement hazard!”
	470115	„Nicht unter schwebende Lasten treten!“ 100 x 100 mm “Do not stand under suspended load!”
	470117	„Gefahren am KDK“ 300 x 100 mm “Hazard at rotary drive (KDK)”
	513293	„Sturzgefahr! Betreten der Schwenktüren verboten!“ 100 x 100 mm “Danger of falling! Stepping on swing doors prohibited!”
	470080	„Gefahr bei Hochspannung! Mindestabstand zu Stromleitungen stets einhalten!“ 110 x 110 mm “High voltage hazard! Always maintain minimum distance from power lines!”

# Zubehör für Geräte











## Accessories for RIGS



Darstellung Illustration	Bauer-Best.Nr. Bauer Item No.	Bezeichnung Description
	470003	„Einfüllbereich Hydrauliköl“ 100 x 100 mm “Hydraulic oil filling area”
	469816	„Einfüllbereich Kraftstoff“ 100 x 100 mm “Fuel filling area”
	470078	„Hebepunkt des Gesamtgerätes“ Ø 100 mm “Equipment lifting point”
	469949	„Hebepunkt der Baugruppe“ Ø 100 mm “Assembly lifting point”
	802648	„Verzurrpunkt“ Ø 100 mm “Lashing point”
	398718	„Betreten des Gefahrenbereichs verboten!“ 270 x 75 mm
	398717	“Entering hazard area prohibited!” 270 x 75 mm
	468968	„Gefahrenbereich betreten verboten!“ Ø 100 mm “Entering hazard area prohibited!”
	468969	„Feuer verboten!“ Ø 100 mm “Fire prohibited!”
	468970	„Rauchen verboten!“ Ø 100 mm “Smoking prohibited!”

# Zubehör für Geräte

## Accessories for RIGS

Darstellung Illustration	Bauer-Best.Nr. Bauer Item No.	Bezeichnung Description
	469969	„Betreten der Fläche verboten!“ Ø 100 mm “Entering area prohibited!”
	470113	„Bohren und Schweißen verboten!“ 30 x 70 mm “Drilling and welding prohibited!”
	991085	„Aufbewahrungsort des Feuerlöschers“ 100 x 100 mm “Location of fire extinguisher”
	513124	„Hauptfahrtrichtung des Gerätes“ 192 x 64 mm “Equipment main direction of travel”
	364799	“Notfall” 117 x 65 mm “Emergency”
	276576	“Zutritt für unbefugte Verboten” 220 x 220 mm “No access for unauthorized persons”
	470073	“Heiße Oberfläche” 100 x 88 mm “Hot surface”
	848388	“Warnweste tragen” 100 x 100 mm “Wear safety vest”
	248286	“Erste Hilfe” 100 x 100 mm “Emergency”
	732199	“Gefahrenstelle” 300 x 100 mm “Danger point”

# Zubehör für Geräte

## Accessories for RIGS



Darstellung Illustration	Bauer-Best.Nr. Bauer Item No.	Bezeichnung Description
	902330	<p>“Warnschilder Fahrerkabine” 180 x 30 mm</p> <p>“Warning signs driver’s cabin”</p>
	469819	<p>“Gefahrenstelle” 100 x 30 mm</p> <p>“Danger point”</p>
	710030	<p>“Gefährliche elektrische Spannung” 100 x 88 mm “</p> <p>“Dangerous electronic tension”</p>
	248287	<p>“Erste Hilfe” 148 x 148 mm</p> <p>“Emergency”</p>
	1037562	<p>“Pfeil nach oben” 100 x 50 mm</p> <p>“Up arrow”</p>
	871629	<p>“BTS” 150 x 105 mm</p> <p>“BTS”</p>
	881512	<p>“Gefahrstoff” 100 x 100 mm</p> <p>“Dangerous substance”</p>



## Service-Koffer Service Cases



---

### Service-Box 304 - 305 Service Box

- Kupfer-, SAE- und O-Ringe | Copper-, SAE- and O-Rings 304 - 305

### Zentralschmierung 306 - 309 Central Lubrication

- BG und MC | BG and MC 306 - 307
- RTG RG/RM | RTG RG/RM 308 - 309

### Elektrik 310 - 331 Electrics

- BG Elektrik I | BG Electrics I 310 - 312
- BG Elektrik II | BG Electrics II 314 - 316
- BG/GB Elektrik III | BG/GB Electrics III 318 - 319
- BG Elektrik IV | BG Electrics IV 320 - 322
- MC Elektrik | MC Electrics 324 - 325
- BC Elektrik I | BC Electrics I 326 - 327
- BC Elektrik II | BC Electrics II 328 - 329
- RG/RM Elektrik | RG/RM Electrics 330 - 331

### Elektrik Steckverbindersortiment 332 - 337 Electric Pin and Socket Connection

- Standard | Standard 332 - 334
- Spezial | Special 336 - 337

### Messen/Analyse Hydraulisch 338 - 342 Measure/Analysis Hydraulic

- Messkoffer Analog | Test Kit Hydraulic Analog 338 - 339
- Messkoffer Digital | Test Kit Hydraulic Digital 340 - 341
- Überwachung Ölproben | Oil Condition Monitoring 342



### Hydraulische Blindkomponenten 344 - 348 Hydraulic Blanking

- Blindkoffer DKO | Plug/Cap Blanking 344 - 345
- SFS – Klein | SAE Flange and Blanking Kit Small 346
- SFS – Mittel – 1 1/4“ | SAE Flange and Blanking Kit Medium 347
- SFS – Groß – 1 1/2“ | SAE Flange and Blanking Kit Large 348

### Service-Koffer-Rack 349 Service Case Rack

# Service-Box



## Service Box

O-Ringe   O-Rings		
Darstellung Illustration	Bauer-Best. Nr. Bauer Item No.	Beschreibung / Verwendung Description / Application
 <p>A yellow plastic case for an O-ring kit, open to show a grid of 24 black O-rings of various sizes. The lid has a label with technical specifications.</p>	63661	<p>O-Ring-Satz Metrisch</p> <p>O-Ring Kit Metric</p>
 <p>A red plastic case for an O-ring kit, open to show a grid of 24 black O-rings of various sizes. The lid has a label with technical specifications.</p>	63662	<p>O-Ring-Satz Zoll</p> <p>O-Ring Kit Inch</p>
 <p>A grey plastic case for an O-ring kit, open to show a grid of 24 black O-rings of various sizes. The lid has a label with technical specifications. Two additional O-rings are shown next to the case.</p>	669092	<p>O-Ring-Satz Metrisch</p> <p>O-Ring Kit Metric</p>



# Service-Box

## Service Box

Kupferringe   Copper Rings			
Darstellung Illustration	Bauer-Best. Nr. Bauer Item No.	Beschreibung / Verwendung Description / Application	
	43638	Kupferring-Sortiment Copper Ring Kit	
SAE-Ringe   SAE Rings			
Darstellung Illustration	Bauer-Best. Nr. Bauer Item No.	Beschreibung Description	
	850432	Service Box SAE Dichtung Service Box SAE Sealing	
		Inhalt Content	Stückzahl Pieces
	675380	Montagewerkzeug Assembling Tool	1x
	72680	Dichtung 1/2" Sealing	30x
	57450	Flanschdichtung SAE 3/4", J 518 Flange Sealing	30x
	45514	Flanschdichtung SAE 1", J 518 Flange Sealing	100x
	57449	Flanschdichtung SAE 1 1/4", J 518 Flange Sealing	100x
	72736	Flanschdichtung SAE 1 1/2", J 518 Flange Sealing	30x











# Zentralschmierung Central Lubrication

BG und MC | BG and MC



- \* Die Werte in Klammern sind die im Koffer enthaltenen Stückzahlen.
- \* Alle Komponenten sind auch einzeln erhältlich.
- \* The values in brackets are the numbers of items included in the case
- \* All components are also available separately.











Bauer-ID: 738380

Darstellung Illustration	Bauer-Best. Nr. Bauer Item No.	Darstellung Illustration	Bauer-Best. Nr. Bauer Item No.
	Bezeichnung Description		Bezeichnung Description
	351759 (5 m)		351774 (5x)
	Polyamidrohr Pipe Polyamid		(Rohrstutzen 90°, L: 38 mm Pipe Connection
	351761 (5 m)		351786 (10x)
	Hochdruckschlauch 8,3 x 2,1 High Pressure Hose		Winkel-Einschraub- verschraubung WE6 M 10 x 1k Elbow Screw Fitting
	351767 (10x)		442731 (4x)
	Schraubhülse für Hochdruckschlauch Thread. Bush High Press. Hose		Winkel-Einschraub- verschraubung WE6 M 8 x 1k Elbow Screw Fitting
	351770 (5x)		351787 (5x)
	Rohrstutzen zur Schraubhülse Pipe Socket Threaded Bush		Gerade Einschraub- verschraubung GE6 M 10 x 1k Screw Fitting
	372796 (5x)		354722 (5x)
	Rohrstutzen 90°, L: 50 mm Pipe Connection		Gerade Verschraubung Tube Fitting Straight



# Zentralschmierung

## Central Lubrication

Darstellung Illustration	Bauer-Best. Nr. Bauer Item No.	Darstellung Illustration	Bauer-Best. Nr. Bauer Item No.
	Bezeichnung Description		Bezeichnung Description
	354726 (5x)		351788 (5x)
	Eck-Verschraubung 45° Tube Fitting Angle-Type		Verlängerung L: 35 mm M 10 x 1k - M 10 x 1 Extension
	351791 (5x)		351789 (5x)
	Eck-Verschraubung EV 90 M 10 x 1k Tube Fitting Angle-Type		Verlängerung L: 50 mm M 10 x 1k-M 10 x 1 Extension
	364360 (5x)		624961 (10x)
	Verlängerung M 8 x 1k - M 10 x 1k Extension		Schneidring Cutting Ring
	615456 (5x)		624960 (10x)
	Verlängerung M 10 x 1, 17,5 mm Extension		Überwurfmutter Coupling Nut
	351790 (5x)		351762 (5 m)
	Verlängerung L: 21 mm M 10 x 1k - M 10 x 1 Extension		Rohrwendel NW 8 x 1,5 L: 50 m Coiled Tubing







# Zentralschmierung Central Lubrication

## RTG RG/RM | RTG RG/RM



- \* Die Werte in Klammern sind die im Koffer enthaltenen Stückzahlen.
- \* Alle Komponenten sind auch einzeln erhältlich.
- \* The values in brackets are the numbers of items included in the case.
- \* All components are also available separately.









Bauer-ID: 766249

Darstellung Illustration	Bauer-Best. Nr. Bauer Item No.	Darstellung Illustration	Bauer-Best. Nr. Bauer Item No.
	Bezeichnung Description		Bezeichnung Description
	767794 (10 m)		767793 (10 m)
	Hochdruckschlauch High Pressure Hose		Plastikrohr Plastic Tubing
	390983 (10x)		425950 (5x)
	Rohrstutzen gerade, steckbar Tube Stub Straight, Plug-in		Rohrstutzen gerade, schraubbar Tube Stub Straight, Screw-in
	416501 (20x)		416502 (10x)
	Kniestück 90°, M 10 x 1 Connector		Kniestück 90°, M 8 x 1 Connector



# Zentralschmierung

## Central Lubrication

Darstellung Illustration	Bauer-Best. Nr. Bauer Item No.	Darstellung Illustration	Bauer-Best. Nr. Bauer Item No.
	Bezeichnung Description		Bezeichnung Description
	390954 (15x)		409651 (15x)
	Schwenkverschraubung M 10 x 1 Connector, Banjo		Rohrverbinder Tube-to-Tube Connector
	390987 (10x)		390889 (15x)
	Hülse Sleeve		Adapter M 10 x 1 Adapter
	765897 (10x)		766248 (10x)
	Kniestück 90°, M 10 x 1 Connector		Adapter M 8 x 1 Adapter
	634717 (15x)		390942 (15x)
	Verbinder M 8 x 1 Connector		Verbinder M 10 x 1 Connector

# Elektrik Electrics

## BG Elektrik I | BG Electrics I



Empfohlen für | recommended for

BGs | BGs:

22, 24, 25, 28, 36, 40 - V

15, 18, 20, 22, 24, 25, 28, 36, 40 - H

Träger-Geräte | Base Machines:

BS 70, 80, 100

BT 40, 50, 60









\* Die Werte in Klammern sind die im Koffer enthaltenen Stückzahlen.

\* Alle Komponenten sind auch einzeln erhältlich.

\* The values in brackets are the numbers of items included in the case

\* All components are also available separately.















Bauer-ID: 796204

Darstellung Illustration	Bauer-Best. Nr. Bauer Item No.	Bezeichnung Description	Darstellung Illustration	Bauer-Best. Nr. Bauer Item No.	Bezeichnung Description
	276562 (1x)	Druckschalter, 5 bar, Würfelstecker Pressure Switch Cubic Plug		438072 (1x)	Näherungsschalter M 18 x 1 mit Kabel 6 m Proximity Switch with cable
	661175 (1x)	Näherungsschalter M 18 x 1 E-Anschluss M 12 Proximity Switch E-Connection		655092 (1x)	Druckmess- umformer, 250 bar, M 12, 1/4" Pressure Transformer
	655093 (1x)	Druckmess- umformer, 400 bar, M 12, 1/4" Pressure Transformer		655091 (1x)	Druckmess- umformer, 40 bar, M 12, 1/4" Pressure Transformer
	1139691 (1x)	Druckschalter, 5 bar, M 12 Pressure Switch		643611 (1x)	Verschmutzungs- anzeiger für   for LFM 12 Dirt Indicator

# Elektrik











## Electrics



Darstellung Illustration	Bauer-Best. Nr. Bauer Item No.	Darstellung Illustration	Bauer-Best. Nr. Bauer Item No.	Darstellung Illustration	Bauer-Best. Nr. Bauer Item No.
	Bezeichnung Description		Bezeichnung Description		Bezeichnung Description
	65430 (2x)		29996 (2x)		38582 (1x)
	Glühlampe H1, 24 V, 70 W Light Bulb		Glühlampe H3, 24 V, 70 W Light Bulb		Steckrelais 24 V, 3 Wechsler Plug-in Relay 3 two-way Contacts
	413038 (1x)		60665 (5x)		250274 (2x)
	Potentiometer 4,7K Ohm		Steckrelais Haltefeder Plug-in Relay Locking Spring		Symboleinsatz Arbeitsschein- werfer vorne Symbol Insert Light, Front
	60713 (30x)		60714 (30x)		427925 (1x)
	Flachsicherung 5 A Blade Fuse		Flachsicherung 7,5 A Blade Fuse		Symboleinsatz Scheibenwischer Symbol Insert Wiper
	60715 (30x)		60718 (30x)		60716 (30x)
	Flachsicherung 10 A Blade Fuse		Flachsicherung 15 A Blade Fuse		Flachsicherung 20 A Blade Fuse
	260421 (3x)		66702 (1x)		65866 (1x)
	Relais Ausgang 1x NO und   and 1x NC Output Relay		Schrittrelais 1x NO und   and 1x NC Step Relay		Schaltrelais 1- und 2-polig Relay 1 and 2 pole

# Elektrik

## Electrics

Darstellung Illustration	Bauer-Best. Nr. Bauer Item No.  Bezeichnung Description	Darstellung Illustration	Bauer-Best. Nr. Bauer Item No.  Bezeichnung Description
	370502 (1x)  Doppel-Schließer-Relais (2x NO) Double Contact Relay		1030154 (2x)  Steckrelais 5 x 6,3 mm Plug-in Relay
	386944 (1x)  Kombischalter gerastet/getastet Combi Switch Latching/Tentative		357023 (1x)  Wechselschalter rastend, 2 Schaltkreise Switch Detend, 2 Circuits
	733772 (1x)  Ventilstecker Adapter M 12, 5-polig, hinten Valve Connection Adapter M 12, 5 pole, Rear		733773 (1x)  Ventilstecker Adapter M 12, 5-polig, oben Valve Connection Adapter M 12, 5 pole, Top
	724342 (5x)  LED-Beleuchtung für Schalter LED-Lighting for Switch		734062 (2x)  Potentiometer 4,7K Ohm Potentiometer
	734063 (1x)  Potentiometer mit Schalter Potentiometer with Switch		380798 (1x)  Potentiometer Motor Drehzahl Potentiometer Engine RPM
	65968 (1x)  Potentiometer-Antrieb mit Drehknopf Potentiometer Drive with Knob		

Service Koffer - MC Elektrik | Service Case - MC Electric ID: 1285794

passend für | suitable for MC 64, 76, 86, 96, 126

<p>1x Isolierbohrer Nichtleitend Pneumatisch 800629</p> 	<p>1x Temperaturfühler Sinter 820996</p> 	<p>1x Schleifbohrer 80   für 107 9812 107 9810/11 805475</p> 	<p>1x Druckmessumformer 400 bar, M12, 1-fach Vollskala, Transmitter 800681</p> 	<p>1x Druckmessumformer 250 bar, M12, 1-fach Pneumatisch Transmitter 800992</p> 	<p>1x Druckmessumformer 40 bar, M12, 1-fach Inferenz Transmitter 800681</p> 
<p>1x Druckmessumformer 500 bar, M12, 1-fach Pneumatisch Transmitter 810882</p> 	<p>1x Druckmessumformer Pneumatisch 374423</p> 	<p>1x Magnetschaltventil 24VDC 220V Nennstrom 60A 811138</p> 	<p>1x Motor 24V Schieber Kabel, Clamping Control 30088</p> 	<p>1x Einbaueinheit Druckhalteventil 1 bar, M12 1110086</p> 	<p>1x 600-Transmitter 10V, 20V, 30V 107 9810 80429</p> 
<p>1x Digital-Analog-Modul NPN 270042</p> 	<p>1x 4-Kanal-Relais 3-pol. DRU7SCH 48 Kabel 4-fach Relais 3-pol. 841968</p> 	<p>1x Ventilführungsventil K1 bis LF M12 2er Packung 642614</p> 	<p>1x Pneumatische Steuerung 800912</p> 	<p>1x Drehmoment Messgerät 780187</p> 	<p>1x 100-1000-Taste mit 1/200-Steuer Energiespar-Schaltrelais mit 1/200-Steuer 804258</p> 
<p>1x Anschlusskabel Analog-Digital 300577</p> 	<p>1x 2-Kanal-Analog 14-10V und 14-10V-Kanal DVI-DK NPN 260021</p> 	<p>1x Pneumatische Motor-Druckluft Steuerung 2-1/2-pol. M12 390736</p> 	<p>1x Einbaueinheit Schaltrelais 821852</p> 	<p>1x 2-Kanal- Steuerung 800200</p> 	<p>1x 2-Kanal-Steuerung Steuerung 800716</p> 
<p>1x Flachkabelschaltung 1 A Stapel-Feder 266488</p> 	<p>1x Flachkabelschaltung 2 A Stapel-Feder 266495</p> 	<p>1x Flachkabelschaltung 3 A Stapel-Feder 80718</p> 	<p>1x Flachkabelschaltung 1 A 4 Stapel-Feder 80714</p> 	<p>1x Flachkabelschaltung 1.5 A Stapel-Feder 80715</p> 	<p>1x Flachkabelschaltung 1.1 A Stapel-Feder 80716</p> 



RAUER Service Case  
24 00000000  
Standard - General



# Elektrik Electrics

## BG Elektrik II | BG Electrics II



Empfohlen für | recommended for

BGs bis 2017 | BGs until 2017

24, 28, 30, 34, - H

30, 39, 42, 46, 50 - V

Träger-Geräte | Base Machines:

BS 95, 115

BT 75, 85













\* Die Werte in Klammern sind die im Koffer enthaltenen Stückzahlen.

\* Alle Komponenten sind auch einzeln erhältlich.

\* The values in brackets are the numbers of items included in the case

\* All components are also available separately.



















Bauer-ID: 1298352

Darstellung Illustration	Bauer-Best. Nr. Bauer Item No.	Darstellung Illustration	Bauer-Best. Nr. Bauer Item No.	Darstellung Illustration	Bauer-Best. Nr. Bauer Item No.
	Bezeichnung Description		Bezeichnung Description		Bezeichnung Description
	1312966 (1x)		643611 (1x)		1139596 (1x)
	Elektronischer Druckschalter 3,5 bar, M 12 Pressure Switch		Verschmutzungs-anzeiger für   for LF M 12 Dirt Indicator		Elektronischer Druckschalter 1 bar, M 12 Pressure Switch
	655091 (1x)		655092 (1x)		1139691 (1x)
	Druckmess-umformer 40 bar, M 12, 1/4" Pressure Transformer		Druckmess-umformer 250 bar, M 12, 1/4" Pressure Transformer		Elektronischer Druckschalter 5 bar, M 12 Pressure Switch
	655093 (1x)		220480 (1x)		357082 (1x)
	Druckmess-umformer 400 bar, M 12, 1/4" Pressure Transformer		Druckreduzier-ventil SW 27 schwarz Pressure Reducing Valve AF 27, Black		Wegeventil 3/2 SW 27, blau Directional Valve 3/2, AF 27, Blue
	661175 (1x)		1026505 (1x)		1037431 (2x)
	Näherungsschalter M 18 x 1 E-Anschluss M 12 Proximity Switch Connection		Magnetspule AMP 24 V Solenoid Coil		Magnetspule für Druckbegren-zungsventil Solenoid Coil for Pressure Valve

# Elektrik

















## Electrics



Darstellung Illustration	Bauer-Best. Nr. Bauer Item No.	Darstellung Illustration	Bauer-Best. Nr. Bauer Item No.	Darstellung Illustration	Bauer-Best. Nr. Bauer Item No.
	Bezeichnung Description		Bezeichnung Description		Bezeichnung Description
	466394 (1x)		738648 (1x)		1411251 (1x)
	Magnetspule AMP 1/2" Solenoid Coil		Proportional- magnet Solenoid Coil		Magnetspule AMP 16 mm Solenoid Coil
	356495 (30x)		356496 (30x)		60713 (30x)
	Flachsteck- sicherung 1 A Blade Fuse		Flachsteck- sicherung 2 A Blade Fuse		Flachsteck- sicherung 5 A Blade Fuse
	60714 (30x)		60715 (30x)		60718 (30x)
	Flachsteck- sicherung 7,5 A Blade Fuse		Flachsteck- sicherung 10 A Blade Fuse		Flachsteck- sicherung 15 A Blade Fuse
	60716 (30x)		250274 (1x)		416376 (1x)
	Flachsteck- sicherung 20 A Blade Fuse		Symboleinsatz Arbeitsschein- werfer Symbol Light Front		Symboleinsatz Frischluft Symbol Fresh Air
	1030154 (2x)		416376 (1x)		427925 (1x)
	Steckrelais 5 x 6, 3 mm Plug-in Relay		Symboleinsatz Klimaanlage Symbol Air Condition		Symboleinsatz Scheibenwischer Symbol Wiper
	36598 (1x)		724342 (3x)		380577 (1x)
	Relais 24 V, Schließer Relay Closing Contact		LED-Beleuchtung für Schalter LED Lightning for Switch		Armlehnschalter Armrest Switch

# Elektrik

## Electrics

Darstellung Illustration	Bauer-Best. Nr. Bauer Item No.	Darstellung Illustration	Bauer-Best. Nr. Bauer Item No.	Darstellung Illustration	Bauer-Best. Nr. Bauer Item No.
	Bezeichnung Description		Bezeichnung Description		Bezeichnung Description
	1277225 (1x)		260421 (2x)		984213 (1x)
	Kontaktblock 1 S Contact Block NO		Relais Ausgang 1x NO und   and 1x NC Kontakt Output Relay Contact		Not-Halt-Taster mit M 30-Hülse Emergency Stop Button with M 30 Sleeve
	1356247 (1x)		29996 (2x)		65430 (2x)
	Relaismodul Relay Module		Kfz-Halogenlampe H3, 24 V, 70 W Light Bulb		Kfz-Halogenlampe H1, 24 V, 70 W Light Bulb
	394063 (1x)		863969 (1x)		380798 (1x)
	Niveauschalter Bajonett- Anschluss Level Switch Bayonet Capling		Niveauschalter 3-polig DEUTSCH mit Kabel Level Switch 3 pole with Cable		Potentiometer Motor Drehzahl Potentiometer Engine RPM
	413038 (2x)		738387 (1x)		413438 (1x)
	Potentiometer 4,7 kOhm Potentiometer		Drehzahlsensor Speed Sensor		Drehzahl-Sensor HDD2L16 PA/20 Speed Sensor
	371767 (1x)		387784 (1x)		246667 (1x)
	Befestigungs- adapter M 22-A, 3-fach Fixed Adapter 3-fold		Gebläseschalter 4-stufig Blower Switch 4-Stage		Verdrahtungs- leitung blau, 5 m, 1 x 0,75 mm <sup>2</sup> Wiring Conductor Blue
	357023 (2x)		386944 (1x)		
	Wechselschalter rastend, 2 Schaltkreise Switch Detend, 2 Circuit		Kombischalter 1. gerastet 2. getastet Combi Switch 1. Latching 2. Tentative		



# Elektrik Electrics

## BG/GB Elektrik III | BG/GB Electrics III



Empfohlen für | recommended for  
BGs/GBs ab 2018 | BGs/GBs from 2018  
15, 18, 20, 23, 28, 33, 36, - H  
33, 36, 45, 55, 72 - V / GB 50, 80

Träger-Geräte | Base Machines:  
BS 95,115  
BT 40, 50, 60, 65, 75, 85  
BT 70D, 80

\* Die Werte in Klammern sind die im Koffer enthaltenen Stückzahlen.

\* Alle Komponenten sind einzeln erhältlich.

\* The values in brackets are the numbers of items included in the case

\* All components are available separately.





Bauer-ID: 1298513

Darstellung Illustration	Bauer-Best. Nr. Bauer Item No.	Darstellung Illustration	Bauer-Best. Nr. Bauer Item No.	Darstellung Illustration	Bauer-Best. Nr. Bauer Item No.
	Bezeichnung Description		Bezeichnung Description		Bezeichnung Description
	1139596 (1x)		1312966 (1x)		655093 (2x)
	Elektronischer Druckschalter 1 bar, M 12 Pressure Switch		Elektronischer Druckschalter 3,5 bar, M 12 Pressure Switch		Druckmessumformer 400 bar, M 12, 1/4“ Pressure Transformer
	394063 (1x)		220480 (2x)		643611 (1x)
	Niveauschalter Bajonett-Anschluss Level Switch Bayonet Capling		Druckreduzierventil SW 27 schwarz Pressure Reducing Valve AF 27, Black		Verschmutzungsanzeiger für   for LF M 12 Dirt Indicator
	1037431 (2x)		1026505 (1x)		1411251 (1x)
	Magnetspule für Druckbegrenzungsventil Solenoid Coil		Magnetspule AMP 24 V Solenoid Coil		Magnetspule AMP 16 mm Solenoid Coil
	738648 (1x)		738387 (1x)		380798 (1x)
	Proportionalmagnet Solenoid Coil		Drehzahlsensor Speed Sensor		Potentiometer Motor Drehzahl Potentiometer Engine RPM

# Elektrik

## Electrics



Darstellung Illustration	Bauer-Best. Nr. Bauer Item No.	Darstellung Illustration	Bauer-Best. Nr. Bauer Item No.	Darstellung Illustration	Bauer-Best. Nr. Bauer Item No.
	Bezeichnung Description		Bezeichnung Description		Bezeichnung Description
	260421 (2x)  Relais Ausgang 1x NO und   and 1x NC Kontakt  Output Relay Contact		36598 (1x)  Relais 24 V, Schließer  Relay Closing Contact		1030154 (2x)  Steckrelais 5 x 6, 3 mm  Plug-in Relay
	1277225 (1x)  Kontaktblock 1 S Contact Block NO		392016 (1x)  Ventilstecker kabel 2-polig AMP, 5 m  Valve Cable 2 pole		1356247 (1x)  Relaismodul Relay Module
	380577 (1x)  Armllehenschalter Armrest Switch		984213 (1x)  Not-Halt-Taster mit M 30-Hülse  Emergency Stop Button with M 30 Sleeve		863969 (1x)  Niveauschalter 3-polig DEUTSCH mit Kabel  Level Switch 3 pole with Cable
	356495 (30x)  Flachsteck- sicherung 1 A  Blade Fuse		356496 (30x)  Flachsteck- sicherung 2 A  Blade Fuse		60713 (30x)  Flachsteck- sicherung 5 A  Blade Fuse
	60714 (30x)  Flachsteck- sicherung 7,5 A  Blade Fuse		60715 (30x)  Flachsteck- sicherung 10 A  Blade Fuse	  60716 (30x)  Flachsteck- sicherung 20 A   Blade Fuse	60718 (30x)  Flachstecksicherung. 15 A   Blade Fuse
	972904 (2x)  Bolzensicherung SF 30 Midi 30 A  Pin Retainer		948309 (2x)  Bolzensicherung SF 51 Mega 100 A  Pin Retainer		948308 (2x)  Bolzensicherung SF 51 Mega 80 A  Pin Retainer

# Elektrik Electrics

## BG Elektrik IV | BG Electrics IV



Empfohlen für | recommended for

BGs ab 2014 | BGs from 2014:

15, 20 - H

26, 30, 38 - V

Träger-Geräte | Base Machines:

BT 50D, BT 80, BT 80BB, BT 70D, BT 70BB













\* Die Werte in Klammern sind die im Koffer enthaltenen Stückzahlen.

\* Alle Komponenten sind auch einzeln erhältlich.

\* The values in brackets are the numbers of items included in the case.



















\* All components are also available separately.

Bauer-ID: 1287158

Darstellung Illustration	Bauer-Best. Nr. Bauer Item No.	Darstellung Illustration	Bauer-Best. Nr. Bauer Item No.	Darstellung Illustration	Bauer-Best. Nr. Bauer Item No.
	Bezeichnung Description		Bezeichnung Description		Bezeichnung Description
	413438 (1x)		359300 (1x)		380798 (1x)
	Drehzahl-Sensor HDD2L16 PA/20  Speed Sensor		Incrementalgeber 3600 Impulse Rotary Encoder		Potentiometer Motor Drehzahl  Potentiometer Engine RPM
	36598 (1x)		1132950 (1x)		260421 (2x)
	Relais 24 V, Schließer  Relay Closing Contact		Relais SPST-NO DM 130 A  Relay		Relais Ausgang 1x NO und   and 1x NC Kontakt Output Relay Contact
	370502 (1x)		948308 (2x)		948309 (2x)
	Doppel-Schliesser- Relais Relay		Bolzensicherung SF 51 Mega 80 A  Pin Retainer		Bolzensicherung SF 51 Mega 100 A  Pin Retainer
	379212 (6x)		1121195 (2x)		972904 (2x)
	Dichtring 13 x 18  Pin Retainer		Bolzensicherung SF 51 Mega 40 A  Pin Retainer		Bolzensicherung SF 30 Midi 30 A  Pin Retainer

# Elektrik Electrics



Darstellung Illustration	Bauer-Best. Nr. Bauer Item No.	Darstellung Illustration	Bauer-Best. Nr. Bauer Item No.	Darstellung Illustration	Bauer-Best. Nr. Bauer Item No.
	Bezeichnung Description		Bezeichnung Description		Bezeichnung Description
	356495 (10x)		356496 (10x)		60713 (10x)
	Flachsteck- sicherung 1 A Blade Fuse		Flachsteck- sicherung 2 A Blade Fuse		Flachsteck- sicherung 5 A Blade Fuse
	60714 (10x)		60715 (10x)		60718 (10x)
	Flachsteck- sicherung 7,5 A Blade Fuse		Flachsteck- sicherung 10 A Blade Fuse		Flachsteck- sicherung 15 A Blade Fuse
	60720 (10x)		380577 (1x)		1139596 (1x)
	Flachsteck- sicherung 25 A Blade Fuse		Armlehnschalter Armrest Switch		Elektronischer Druckschalter 1 bar, M 12 Pressure Switch
	1312966 (1x)		643611 (1x)		655473 (1x)
	Elektronischer Druckschalter 3,5 bar, M 12 Pressure Switch		Verschmutzungs- anzeiger für   for LF M 12 Dirt Indicator		Staudruck- anzeiger für   for RF M 12 Dynamic Pressure Indicator
	1139691 (1x)		220480 (1x)		357082 (1x)
	Elektronischer Druckschalter 5 bar, M 12 Pressure Switch		Druckreduzier- ventil SW 27 schwarz Pressure Reducing Valve AF 27, Black		Wegeventil 3/2 SW 27, blau Directional Valve 3/2, AF 27, Blue
	655091 (1x)		655093 (1x)		692212 (1x)
	Druckmess- umformer 40 bar, M 12, 1/4" Pressure Transformer		Druckmess- umformer 400 bar, M 12, 1/4" Pressure Transformer		Spule Spool

# Elektrik

## Electrics

Darstellung Illustration	Bauer-Best. Nr. Bauer Item No.	Darstellung Illustration	Bauer-Best. Nr. Bauer Item No.	Darstellung Illustration	Bauer-Best. Nr. Bauer Item No.
	Bezeichnung Description		Bezeichnung Description		Bezeichnung Description
	466394 (1x) Magnetspule AMP 1/2" Solenoid Coil		472595 (1x) Magnetspule Solenoid Coil		1411251 (1x) Magnetspule AMP 16 mm Solenoid Coil
	692209 (1x) Spule Spool		738648 (1x) Proportional- magnet Solenoid Coil		1061529 (1x) Proportional- magnet AMP Solenoid Coil
	357023 (1x) Wechselschalter rastend, 2 Schaltkreise Switch Detend, 2 Circuits		386944 (1x) Kombischalter gerastet/getastet Combi Switch Latching/Tentative		371768 (1x) Front Kontaktelement M 22-K01 Öffner Front Element Opening Contact
	371769 (1x) Front Kontaktelement M 22-K01 Schließer Front Element Opening Contact		384323 (1x) Front LED-Element M 22-LED-G LED-Element Front		1277225 (1x) Kontaktblock 1 S Contact Block NO
	384666 (1x) Leuchtdrucktaste grün M 22 Illuminated Push Button Green		645295 (1x) Leuchtwahlta- sten M 22-WRLK-R Fluorescent Key		724342 (1x) LED-Beleuchtung für Schalter LED Lightning for Switch
	413038 (1x) Potentiometer 4,7 kOhm Potentiometer		371767 (1x) Befestigungs- adapter M 22-A, 3-fach Fixed Adapter 3-fold		392016 (1x) Ventilstecker- kabel 2-polig AMP, 5 m Valve Cable 2 pole
	22242 (2x) Dichtkantenring Edge Sealing Ring		393333 (2x) Gummitaster-Set für Joystickgriff Rubber Button Set for Joystick Handle		



# Elektrik Electrics

## MC Elektrik | MC Electrics



Empfohlen für | recommended for

MCs | MCs:  
64, 76, 86, 96, 128









\* Die Werte in Klammern sind die im Koffer enthaltenen Stückzahlen.

\* Alle Komponenten sind auch einzeln erhältlich.

\* The values in brackets are the numbers of items included in the case.

\* All components are also available separately.



















Bauer-ID: 1285796

Darstellung Illustration	Bauer-Best. Nr. Bauer Item No.	Darstellung Illustration	Bauer-Best. Nr. Bauer Item No.	Darstellung Illustration	Bauer-Best. Nr. Bauer Item No.
	Bezeichnung Description		Bezeichnung Description		Bezeichnung Description
	860529 (1x)		526906 (1x)		655473 (1x)
	Induktiver Näherungssensor Proximity Sensor		Temperatur- messumformer Temperature Transmitter		Staudruck- anzeiger für   for RF M 12 Dynamic Pressure Indicator
	655093 (1x)		655092 (1x)		655091 (1x)
	Druckmess- umformer 400 bar, M 12, 1/4" Pressure Transformer		Druckmess- umformer 250 bar, M 12, 1/4" Pressure Transformer		Druckmess- umformer 40 bar, M 12, 1/4" Pressure Transformer
	655452 (1x)		374439 (1x)		1139596 (1x)
	Druckmess- umformer 100 bar, M 12, 1/4" Pressure Transformer		Druckreduzier- ventil Pressure Reducing Valve		Elektronischer Druckschalter 1 bar, M 12 Pressure Switch
	643611 (1x)		36598 (1x)		370502 (2x)
	Verschmutzungs- anzeiger für   for LF M 12 Dirt Indicator		Relais 24 V, Schließer Relay Closing Contact		Doppel-Schließer- Relais Relay

# Elektrik

## Electrics



Darstellung Illustration	Bauer-Best. Nr. Bauer Item No.	Darstellung Illustration	Bauer-Best. Nr. Bauer Item No.	Darstellung Illustration	Bauer-Best. Nr. Bauer Item No.
	Bezeichnung Description		Bezeichnung Description		Bezeichnung Description
	356495 (10x)		356496 (10x)		60713 (10x)
	Flachsteck- sicherung 1 A Blade Fuse		Flachsteck- sicherung 2 A Blade Fuse		Flachsteck- sicherung 5 A Blade Fuse
	60714 (10x)		60715 (10x)		60718 (10x)
	Flachsteck- sicherung 7,5 A Blade Fuse		Flachsteck- sicherung 10 A Blade Fuse		Flachsteck- sicherung 15 A Blade Fuse
	60716 (10x)		65430 (2x)		863969 (1x)
	Flachsteck- sicherung 20 A Blade Fuse		Kfz-Halogenlampe H 1, 24 V, 70 W Light Bulb		Niveauschalter 3-polig DEUTSCH mit Kabel Level Switch 3 pole with Cable
	738387 (1x)		984213 (1x)		380798 (1x)
	Drehzahl- sensor Speed Sensor		Not-Halt-Taster mit M 30-Hülse Emergency Stop Button with M 30 Sleeve		Potentiometer Motor Drehzahl Potentiometer Engine RPM
	663080 (1x)		380577 (1x)		260421 (2x)
	Temperatur- sensor Temperature Sensor		Armlehnschalter Armrest Switch		Relais Ausgang 1x NO und   and 1x NC Kontakt Output Relay Contact
	692912 (1x)		412759 (1x)		874162 (1x)
	Proportional- magnet Solenoid Coil		Magnetspule GZ37-4 24 VDC, 22 W Solenoid Coil		Endschalter Switch

# Elektrik Electrics

## BC Elektrik I | MC Electrics I



Empfohlen für | recommended for

BCs | BCs:  
30, 32, 40









\* Die Werte in Klammern sind die im Koffer enthaltenen Stückzahlen.

\* Alle Komponenten sind auch einzeln erhältlich.

\* The values in brackets are the numbers of items included in the case

\* All components are also available separately.











Bauer-ID: 1278539

Darstellung Illustration	Bauer-Best. Nr. Bauer Item No.	Darstellung Illustration	Bauer-Best. Nr. Bauer Item No.
	Bezeichnung Description		Bezeichnung Description
	625278 (1x)		762619 (1x)
	Druckmess- umformer 20 bar, M 12, 1“ Pressure Transformer		Druckmess- umformer 2,5 bar, M 12, kpl. Pressure Transformer, cpl.
	666098 (1x)		642295 (1x)
	Druckmess- umformer 20 bar, M 12, 1/4“ Pressure Transformer		Temperatur- und Wassergehaltssensor Temperature and Water Content Sensor
	66445 (1x)		66400 (1x)
	Druckmess- umformer 40 bar, Würfel, 1/2“ Pressure Transformer, Cubic		Druckmess- umformer 250 bar, Würfel, 1/2“ Pressure Transformer, Cubic
	384897 (1x)		384899 (1x)
	Wahltaste M 22-WRK 2 Stellungen, rastend Selector Key 2 positions, latching		Wahltaste M 22-WRK 3 Stellungen, rastend Selector Key 3 positions, latching

# Elektrik

## Electrics



Darstellung Illustration	Bauer-Best. Nr. Bauer Item No.	Darstellung Illustration	Bauer-Best. Nr. Bauer Item No.
	Bezeichnung Description		Bezeichnung Description
	19535 (1x)		65652 (1x)
	Näherungsschalter L: 61 mm, M 18 x 1 Proximity Switch		Optoelektronische Niveausonde Photoelectric Level Sensor
	963851 (1x)		352878 (1x)
	Magnetspule Solenoid Coil		Winkelaufnehmer 0 - 360° Angle Sensor
	260421 (3x)		371769 (2x)
	Relais Ausgang 1x NO und   and 1x NC Kontakt Output Relay Contact		Front Kontaktelement M 22-K01 Schließer Front Element Opening Contact
	65728 (10x)		413038 (2x)
	Sicherung 2 A Fuse		Potentiometer 4,7 kOhm Potentiometer
	65415 (1x)		246978 (1x)
	Näherungs- schalter Proximity Switch		Adapterkabel kpl. - Fräse - Druckausgleich Adapter Cable cpl. - Cutter - Pressure Balance
	795846 (1x)		
	Elektrischer Installations- Näherungsschalter mit 3-poligem K-Stecker Electric Installation Proximity Switch with 3 pole K-Plug		

# Elektrik Electrics

## BC Elektrik II | MC Electrics II



Empfohlen für | recommended for

BCs | BCs:  
35, 48









\* Die Werte in Klammern sind die im Koffer enthaltenen Stückzahlen.

\* Alle Komponenten sind auch einzeln erhältlich.

\* The values in brackets are the numbers of items included in the case

\* All components are also available separately.











Bauer-ID: 1282795

Darstellung Illustration	Bauer-Best. Nr. Bauer Item No.	Darstellung Illustration	Bauer-Best. Nr. Bauer Item No.
	Bezeichnung Description		Bezeichnung Description
	625278 (1x)		759175 (1x)
	Druckmess- umformer 20 bar, M 12, 1" Pressure Transformer		Druckaufnehmerr PR 130 - 2,5 bar Pressure Transformer
	655093 (1x)		655091 (1x)
	Druckmess- umformer 400 bar, M 12, 1/4" Pressure Transformer		Druckmess- umformer 40 bar, M 12, 1/4" Pressure Transformer
	666098 (1x)		65652 (1x)
	Druckmess- umformer 20 bar, M 12, 1/4" Pressure Transformer		Optoelektronische Niveausonde Photoelectric Level Sensor
	624806 (1x)		1197721 (1x)
	Temperatur- und Wassersensor -40° - +130° C, M 12 Temperature and Water Control		Druckreduzierventil Pressure Reducing Valve

# Elektrik

## Electrics



Darstellung Illustration	Bauer-Best. Nr. Bauer Item No.	Darstellung Illustration	Bauer-Best. Nr. Bauer Item No.
	Bezeichnung Description		Bezeichnung Description
	795846 (1x)		795845 (1x)
	Elektrischer Installations-Näherungsschalter mit 3-poligem K-Stecker <a href="#">Electric Installation Proximity Switch with 3 pole K-Plug</a>		Elektrischer Installations-Näherungsschalter mit 3-poligem D-Stecker <a href="#">Electric Installation Proximity Switch with 3 pole D-Plug</a>
	1208397 (1x)		1114787 (1x)
	Elektrischer Installations-Dispo Adapter 3-polig Kom. - DT04-3P <a href="#">Electric Installation Dispo Adapter 3 pole</a>		Magneto - Induktiver Wegsensor <a href="#">Inductive Displacement Sensor</a>
	848886 (1x)		413038 (2x)
	Drehwinkelgeber <a href="#">Swing Angle Sensor</a>		Potentiometer 4,7 kOhm <a href="#">Potentiometer</a>
	384897 (1x)		384899 (1x)
	Wahl taste M 22-WRK 2 Stellungen, rastend <a href="#">Selector Key 2 positions, latching</a>		Wahl taste M 22-WRK 3 Stellungen, rastend <a href="#">Selector Key 3 positions, latching</a>
	356496 (10x)		371769 (2x)
	Flachsteck-sicherung 2 A <a href="#">Blade Fuse</a>		Front Kontaktelement M 22-K01 Schließer <a href="#">Front Element Opening Contact</a>
	65728 (10x)		
	Sicherung 2 A <a href="#">Fuse</a>		

# Elektrik Electrics



## RG/RM Elektrik | RG/RM Electrics



\* Die Werte in Klammern sind die im Koffer enthaltenen Stückzahlen.  
 \* Alle Komponenten sind auch einzeln erhältlich.  
 \* The values in brackets are the numbers of items included in the case  
 \* All components are also available separately.

Bauer-ID: 1032204









Darstellung Illustration	Bauer-Best. Nr. Bauer Item No.
	Bezeichnung Description
	655091 (1x)
	Druckmessumformer 40 bar E-Anschluss M 12 Pressure Transformer
	643611 (1x)
	Verschmutzungsanzeiger für   for LF / E-Anschluss M 12 Dust Indicator E-Connection
	276562 (1x)
	Membrandruckschalter 5 bar Pressure Switch
	738387 (1x)
	Drehzahlsensor Speed Sensor (rpm)
	36598 (1x)
	Relais Relay









Darstellung Illustration	Bauer-Best. Nr. Bauer Item No.
	Bezeichnung Description
	655093 (1x)
	Druckmessumformer 400 bar E-Anschluss M 12 Pressure Transformer
	1139691 (1x)
	Elektronischer Druckschalter 5 bar, M 12 Pressure Switch
	715884 (1x)
	Membrandruckschalter 2,5 bar Pressure Switch
	1030154 (4x)
	Kfz-Relais 1x UM Automotive Relay
	260421 (3x)
	Relais Ausgang 1x NO und 1x NC Output Relay 1x NO / 1x NC

# Elektrik

## Electrics



Darstellung Illustration	Bauer-Best. Nr. Bauer Item No.
	Bezeichnung Description
	413038 (1x)
	Potentiometer 4,7K Ohm
	38582 (1x)
	Relais 3 x UM   Relay
	60665 (5x)
	Haltefeder   Locking Spring
	661175 (1x)
	Näherungsschalter M 12 Proximity Switch
	863969 (1x)
	Niveauschalter Kühlwasser Coolant Level Switch
	65430 (2x)
	Glühlampe H1, 24 V, 70 W Light Bulb
	60713 (30x)
	Flachsicherung 5 A Blade Fuse
	60715 (30x)
	Flachsicherung 10 A Blade Fuse
	60716 (30x)
	Flachsicherung 20 A Blade Fuse

Darstellung Illustration	Bauer-Best. Nr. Bauer Item No.
	Bezeichnung Description
	380798 (1x)
	Potentiometer Motor Drehzahl Motor Speed
	385833 (1x)
	Schlüsselschalter M 22 Key Switch
	380577 (1x)
	Armlehenschalter Armrest Switch
	394063 (1x)
	Niveauschalter Diesel Fuel Level Switch
	29996 (2x)
	Glühlampe H3, 24 V, 70 W Light Bulb
	66484 (1x)
	Temperaturfühler MR Temperature Sensor MR
	60714 (30x)
	Flachsicherung 7,5 A Blade Fuse
	60718 (30x)
	Flachsicherung 15 A Blade Fuse

# Elektrik Steckverbindersortiment











## Electric Pin and Socket Connection

Standard | Standard



\* Die Werte in Klammern sind die im Koffer enthaltenen Stückzahlen.  
 \* Alle Komponenten sind auch einzeln erhältlich.  
 \* The values in brackets are the numbers of items included in the case  
 \* All components are also available separately.

Bauer-ID: 734937

Darstellung Illustration	Bauer-Best. Nr. Bauer Item No.	Darstellung Illustration	Bauer-Best. Nr. Bauer Item No.	Darstellung Illustration	Bauer-Best. Nr. Bauer Item No.
	Bezeichnung Description		Bezeichnung Description		Bezeichnung Description
Aderendhülse Conductor Sleeve		Aderendhülse Conductor Sleeve		Ringkabelschuh Ring Cable Lug	
	901382 (100x) 0,75 mm <sup>2</sup>		66054 (100x) 4 mm <sup>2</sup>		63392 (30x) M 5 2,5 mm <sup>2</sup>
	901383 (100x) 1,5 mm <sup>2</sup>		66053 (50x) 6 mm <sup>2</sup>		66050 (30x) M 6 2,5 mm <sup>2</sup>
	87213 (100x) 2,5 mm <sup>2</sup>		370403 (25x) 10 mm <sup>2</sup>		246302 (30x) M 8 2,5 mm <sup>2</sup>
Crimp-Stift Crimp Pin		Crimp-Buchse Crimp Contact		Flachsteckhülse Receptacle for Tabs	
	370475 (100x) 0,5 mm <sup>2</sup>		370476 (100x) 0,5 mm <sup>2</sup>		60031 (30x) 6,3 mm 1,5 - 2,5 mm <sup>2</sup>
	68685 (100x) 1 mm <sup>2</sup>		68687 (100x) 1 mm <sup>2</sup>		43124 (30x) 6,3 mm 4 - 6 mm <sup>2</sup>
	68686 (100x) 1,5 mm <sup>2</sup>		68688 (100x) 1,5 mm <sup>2</sup>		

# Elektrik Steckverbindersortiment











## Electric Pin and Socket Connection



Darstellung Illustration	Bauer-Best. Nr. Bauer Item No.	Darstellung Illustration	Bauer-Best. Nr. Bauer Item No.	Darstellung Illustration	Bauer-Best. Nr. Bauer Item No.
	Bezeichnung Description		Bezeichnung Description		Bezeichnung Description
	60030 (30x)		260420 (30x)		901385 (30x)
	Serienverbinder 2,5 mm <sup>2</sup> Butt Connector		Flachsteckhülse vollisoliert 6,3 mm, 2,5 mm <sup>2</sup> Receptacle for Tabs full isolated		Flachsteckhülse isoliert 6,3 mm, 2,5 mm <sup>2</sup> Receptacle for Tabs isolated
	66069 (30x)		42109 (30x)		901387 / 6,3 mm, 1,5 - 2,5 mm <sup>2</sup>
	Flachsteckhülse isoliert 4,8 mm, 2,5 mm <sup>2</sup> Receptacle for Tabs isolated		Flachsteckhülse isoliert 2,8 mm, 2,5 mm <sup>2</sup> Receptacle for Tabs isolated		66075 / 6,3 mm, 4 - 6 mm <sup>2</sup>
	63383 (5x)		63384 (5x)		66074 (5x)
	Steckergehäuse 2-polig Connector Casing 2 pole H-Form   Shape		Buchsengehäuse 2-polig Bush Housing 2 pole H-Form   Shape		Steckergehäuse 2-polig Connector Casing 2 pole T-Form   Shape
	66073 (5x)		66071 (5x)		66072 (5x)
	Buchsengehäuse 2-polig Bush Housing 2 pole T-Form   Shape		Steckergehäuse 3-polig Connector Casing 3 pole		Buchsengehäuse 3-polig Bush Housing 3 pole
	63381 (4x)		63382 (4x)		63385 (2x)
	Steckergehäuse 4-polig Connector Casing 4 pole		Buchsengehäuse 4-polig Bush Housing 4 pole		Steckergehäuse 6-polig Connector Casing 6 pole
	63386 (2x)		61204 (1x)		61205 (1x)
	Buchsengehäuse 6-polig Bush Housing 6 pole		Steckergehäuse 8-polig Connector Casing 8 pole		Buchsengehäuse 8-polig Bush Housing 8 pole

# Elektrik Steckverbindersortiment

## Electric Pin and Socket Connection

Darstellung Illustration	Bauer-Best. Nr. Bauer Item No.	Darstellung Illustration	Bauer-Best. Nr. Bauer Item No.
	Bezeichnung Description		Bezeichnung Description
	228692 (2x)		733283 (1x)
	Steckverbinder 2-polig Multipole Connector 2 pole		Crimpzange Crimping Tool
	66076 (10x)		733284 (1x)
	Elastik-Leit. Verteil 3-polig Distributor 3 pole		Crimpeinsatz Quetschverbinder isoliert Crimp Insert Terminals with Insulation Sleeves
	370970 (10x)		733286 (1x)
	Flachsteckverbinder 4-polig Plug Strip Connector 4 pole		Crimpeinsatz Quetschverbinder unisoliert Crimp Insert Terminals without Insulation Sleeves
	246649 (1x)		733285 (1x)
	Ausdrückwerkzeug Crimp-Stifte-Buchsen Harting Extraction Tool Crimp Insert Harting Connector Bushes		Crimpeinsatz Aderendhülsen Crimp Insert Core Cable Ends
	90007 (1x)		733287 (1x)
	Schraubendreher Gr. 1 Screw Driver Size 1		Crimpeinsatz Crimp-Stifte-Buchsen Harting Crimp Insert Harting Connector Pins - Bushes



## myBAUER

### *The Service Platform on the Internet*



#### Was ist myBAUER?

- 24/7 Kundenportal
- Online-Ersatzteilkatalog
- Flottenmanagement
- Warenkorb
- Informationsstelle
- Anbindung von WEB-BGM und vieles mehr



#### Vorteile für Sie:

- Sie bestellen ganz einfach über unseren Online-Ersatzteilkatalog – weltweit und rund um die Uhr
- Wir stellen Ihnen Ihre Gerätestücklisten und -dokumentationen online zur Verfügung
- Sie sparen Zeit bei der Suche nach passenden Ersatz- und Serviceteilen
- Wir archivieren Ihre Bestellungen und Sie können diese als Kopiervorlage wiederverwenden

#### *What is myBAUER?*

- *24/7 customer portal*
- *Online spare parts catalogue*
- *Fleet management*
- *Shopping cart*
- *Information source*
- *connection to WEB-BGM and much more*

#### *Benefits for you*

- *Order easily via Internet – worldwide and 24/7*
- *You have online access to your parts lists and technical documentations at any time*
- *You save time searching for the required spare parts and wear and tear parts*
- *Your orders are recorded to be reused in full or in parts of it*













# Elektrik Steckverbindersortiment Electric Pin and Socket Connection

**Spezial | Special**



\* Die Werte in Klammern sind die im Koffer enthaltenen Stückzahlen.  
\* Alle Komponenten sind auch einzeln erhältlich.  
\* The values in brackets are the numbers of items included in the case  
\* All components are also available separately.

**Bauer-ID: 734978**

Darstellung Illustration	Bauer-Best. Nr. Bauer Item No.	Darstellung Illustration	Bauer-Best. Nr. Bauer Item No.	Darstellung Illustration	Bauer-Best. Nr. Bauer Item No.
	Bezeichnung Description		Bezeichnung Description		Bezeichnung Description
	356598 (10x) Steckergehäuse mit Endkappe 2-polig Plug Case 2 pole		370481 (8x) Steckergehäuse mit Endkappe 3-polig Plug Case 3 pole		370495 (5x) Dose 4-polig Socket 4 pole
	360556 (5x) Dose 6-polig Socket 6 pole		381838 (2x) Steckergehäuse mit Endkappe 8-polig Plug Case 8 pole		381839 (2x) Steckergehäuse mit Endkappe 12-polig Plug Case 12 pole
	356599 (10x) Stecker 2-polig Plug 2 pole Keil   Wedge		370492 (8x) Stecker 3-polig Plug 3 pole Keil   Wedge		370496 (5x) Dose 4-polig Socket 4 pole Keil   Wedge
	360558 (5x) Dose 6-polig Socket 6 pole Keil   Wedge		381923 (2x) Stecker 8-polig Plug 8 pole Keil   Wedge		381924 (2x) Stecker 12-polig Plug 12 pole Keil   Wedge

# Elektrik Steckverbindersortiment

## Electric Pin and Socket Connection



Darstellung Illustration	Bauer-Best. Nr. Bauer Item No.	Darstellung Illustration	Bauer-Best. Nr. Bauer Item No.	Darstellung Illustration	Bauer-Best. Nr. Bauer Item No.
	Bezeichnung Description		Bezeichnung Description		Bezeichnung Description
	356595 (10x)		370479 (8x)		370493 (5x)
	Stecker mit Endkappe 2-polig Plug with End Cap 2 pole		Stecker mit Endkappe 3-polig Plug with End Cap 3 pole		Stecker 4-polig Plug 4 pole
	360555 (5x)		381835 (2x)		381837 (2x)
	Stecker 6-polig Plug 6 pole		Stecker 8-polig Plug 8 pole		Stecker 12-polig Plug 12 pole
	356596 (10x)		370480 (8x)		370494 (5x)
	Stecker 2-polig Plug 2 pole Keil   Wedge		Stecker 3-polig Plug 3 pole Keil   Wedge		Stecker 4-polig Plug 4 pole Keil   Wedge
	360557 (5x)		381840 (2x)		381841 (2x)
	Stecker 6-polig Plug 6 pole Keil   Wedge		Stecker 8-polig Plug 8 pole Keil   Wedge		Stecker 12-polig Plug 12 pole Keil   Wedge
	370497 (100x)		370498 (100x)		505209 (1x)
	Stiftkontakt 1 mm <sup>2</sup> Contact Pin		Buchsenkontakt 1 mm <sup>2</sup> Bushing Contact		Auspin Werkzeug Kontakte Demounting Tool Contacts
	356600 (100x)		356597 (100x)		505208 (1x)
	Stiftkontakt 1,5 mm <sup>2</sup> Contact Pin		Buchsenkontakt 1,5 mm <sup>2</sup> Bushing Contact		Auspin Werkzeug Kontakte Demounting Tool Contacts
	356601 (1x)		735455 (1x)		427154 (50x)
	Universal Press- zange Kontakte Contact Plier		Auspin Werkzeug Kontakte Demounting Tool Contacts		Dichtstecker weiß Plug White

# Messen/Analyse Hydraulisch Measure/Analysis Hydraulic

Messkoffer analog | Test Kit hydraulic analog



\* Die Werte in Klammern sind die im Koffer enthaltenen Stückzahlen.  
 \* Alle Komponenten sind auch einzeln erhältlich.  
 \* The values in brackets are the numbers of items included in the case  
 \* All components are also available separately.





Bauer-ID: 734655

Darstellung Illustration	Bauer-Best. Nr. Bauer Item No.	Bezeichnung Description
	11673	(4x) Überwurfmutter M 18 x 1,5 - 12 L   <a href="#">Box Nut</a>
	11676	(2x) Überwurfmutter M 22 x 1,5 - 15 L   <a href="#">Box Nut</a>
	240538	(4x) Überwurfmutter M 16 x 1,5 - 8 S   <a href="#">Box Nut</a>
	21489	(4x) Verschraubung 12 L   <a href="#">Screwing</a>
	36680	(2x) Verschraubung 15 L   <a href="#">Screwing</a>
	30469	(4x) Verschraubung 8 S   <a href="#">Screwing</a>
	235546	(4x) Verschlusskegel 12 S/L   <a href="#">Locking Cone</a>
	235538	(2x) Verschlusskegel 15 L   <a href="#">Locking Cone</a>
	235539	(4x) Verschlusskegel 8 S/L   <a href="#">Locking Cone</a>
		34956
27557		(2x) Minimessanschluss 15 L   <a href="#">Minimeter Connection</a>
20023		(4x) Minimessanschluss 8 S   <a href="#">Minimeter Connection</a>
	22068	(2x) Minimessanschluss 1/4"   <a href="#">Minimeter Connection</a>
	27552	(2x) Minimessanschluss 1/2"   <a href="#">Minimeter Connection</a>
	25062	(2x) Minimessanschluss 3/8"   <a href="#">Minimeter Connection</a>
	34951	(2x) Minimessanschluss 12 x 1,5   <a href="#">Minimeter Connection</a>
	27556	(2x) Minimessanschluss 14 x 1,5   <a href="#">Minimeter Connection</a>

# Messen/Analyse Hydraulisch

## Measure/Analysis Hydraulic



Darstellung Illustration	Bauer-Best. Nr. Bauer Item No.	Bezeichnung Description
	230817	(4x) L-Stutzen 8 S   <a href="#">L-Fitting</a>
	230820	(4x) L-Stutzen 12 L   <a href="#">L-Fitting</a>
	230823	(3x) L-Stutzen 15 L   <a href="#">L-Fitting</a>
	230837	(4x) T-Stutzen 8 S   <a href="#">T-Fitting</a>
	230840	(4x) T-Stutzen 12 L   <a href="#">T-Fitting</a>
	230843	(3x) T-Stutzen 15 L   <a href="#">T-Fitting</a>
	30856	(1x) Manometer Analog 10 bar G 1/4"   <a href="#">Manometer</a>
	20394	(1x) Manometer Analog 60 bar G 1/4"   <a href="#">Manometer</a>
	26603	(1x) Manometer Analog 400 bar G 1/4"   <a href="#">Manometer</a>
	27573	(3x) Minimessanschluss   <a href="#">Minimeter Connection</a> inkl. Dichtkantenring   <a href="#">incl. Edged Sealing Ring</a>
	48048	(1x) Manometeranschluss-Schlauch 1000 mm <a href="#">Manometer Connection Hose</a>
	22978	(1x) Manometeranschluss-Schlauch 2500 mm <a href="#">Manometer Connection Hose</a>
	76552	(1x) Manometeranschluss-Schlauch 5000 mm <a href="#">Manometer Connection Hose</a>

# Messen/Analyse Hydraulisch

## Measure/Analysis Hydraulic

### Messkoffer digital | Test Kit hydraulic digital



- \* Die Werte in Klammern sind die im Koffer enthaltenen Stückzahlen.
- \* Alle Komponenten sind auch einzeln erhältlich.
- \* The values in brackets are the numbers of items included in the case
- \* All components are also available separately.





Bauer-ID: 734656

Darstellung Illustration	Bauer-Best. Nr. Bauer Item No.	Bezeichnung Description
	11673	(4x) Überwurfmutter M 18 x 1,5 - 12 L   Box Nut
	11676	(2x) Überwurfmutter M 22 x 1,5 - 15 L   Box Nut
	240538	(4x) Überwurfmutter M 16 x 1,5 - 8 S   Box Nut
	21489	(4x) Verschraubung 12 L   Screwing
	36680	(2x) Verschraubung 15 L   Screwing
	30469	(4x) Verschraubung 8 S   Screwing
	235546	(4x) Verschlusskegel 12 S/L   Locking Cone
	235538	(2x) Verschlusskegel 15 L   Locking Cone
	235539	(4x) Verschlusskegel 8 S/L   Locking Cone
		34956
27557		(2x) Minimessanschluss 15 L   Minimeter Connection
20023		(4x) Minimessanschluss 8 S   Minimeter Connection
22068		(2x) Minimessanschluss 1/4"   Minimeter Connection
27552		(2x) Minimessanschluss 1/2"   Minimeter Connection
25062		(2x) Minimessanschluss 3/8"   Minimeter Connection
34951		(2x) Minimessanschluss 12 x 1,5   Minimeter Connection
27556		(2x) Minimessanschluss 14 x 1,5   Minimeter Connection

# Messen/Analyse Hydraulisch

## Measure/Analysis Hydraulic



Darstellung Illustration	Bauer-Best. Nr. Bauer Item No.	Bezeichnung Description
	230817	(4x) L-Stutzen 8 S   <a href="#">L-Fitting</a>
	230820	(4x) L-Stutzen 12 L   <a href="#">L-Fitting</a>
	230823	(3x) L-Stutzen 15 L   <a href="#">L-Fitting</a>
	230837	(4x) T-Stutzen 8 S   <a href="#">T-Fitting</a>
	230840	(4x) T-Stutzen 12 L   <a href="#">T-Fitting</a>
	230843	(3x) T-Stutzen 15 L   <a href="#">T-Fitting</a>
	966545	(1x) Digital Manometer G 1/4"   <a href="#">Manometer Digital</a>
	459111	(1x) Gummischutz für Manometer Digital <a href="#">Rubber Cover for Manometer Digital</a>
	27573	(1x) Minimessanschluss   <a href="#">Minimeter Connection</a> inkl. Dichtkantenring   <a href="#">incl. Edged Sealing Ring</a>
	48048	(1x) Manometeranschluss-Schlauch 1000 mm <a href="#">Manometer Connection Hose</a>
	22978	(1x) Manometeranschluss-Schlauch 2500 mm <a href="#">Manometer Connection Hose</a>
	76552	(1x) Manometeranschluss-Schlauch 5000 mm <a href="#">Manometer Connection Hose</a>





# Messen/Analyse Hydraulisch Measure/Analysis Hydraulic

## Überwachung Ölproben | Oil Condition Monitoring



\* Die Werte in Klammern sind die im Koffer enthaltenen Stückzahlen.  
 \* Alle Komponenten sind auch einzeln erhältlich.  
 \* The values in brackets are the numbers of items included in the case  
 \* All components are also available separately.

Bauer-ID: 812147

Darstellung Illustration	Bauer-Best. Nr. Bauer Item No.	Darstellung Illustration
	798103	Ersatz-Ölprobenbehälter ohne Deckel Replacement Oil Sample Container without Latch
	798104	Ersatz-Verschlüsse Replacement Latches
Zusätzlich verfügbar   Additionally available		
Darstellung Illustration	Bauer-Best. Nr. Bauer Item No.	Bezeichnung Description
	1097949	Analyseset BAUER Spezial grau Analysis Set BAUER Special grey
	387559	Probenpumpe passend zu Bauer-ID Sample Pump Suitable for Bauer-ID



# Hydraulische Blindkomponenten Hydraulic Blanking

## Blindkoffer DKO | Plug/Cap Blanking



\* Die Werte in Klammern sind die im Koffer enthaltenen Stückzahlen.  
 \* Alle Komponenten sind auch einzeln erhältlich.  
 \* The values in brackets are the numbers of items included in the case  
 \* All components are also available separately.

Bauer-ID: 734652

Darstellung Illustration	Bauer-Best. Nr. Bauer Item No.	Bezeichnung Description
	240609	(2x) Verschlusschraube 1/4"   Locking Screw
	240607	(2x) Verschlusschraube 1/2"   Locking Screw
	240614	(2x) Verschlusschraube 3/8"   Locking Screw
	240612	(2x) Verschlusschraube 3/4"   Locking Screw
	240615	(2x) Verschlusschraube 1"   Locking Screw
	11671	(4x) Überwurfmutter M 14 x 1,5 - 8 L   Box Nut
	240539	(4x) Überwurfmutter M 16 x 1,5 - 10 L   Box Nut
	11673	(4x) Überwurfmutter M 18 x 1,5 - 12 L   Box Nut
	11676	(4x) Überwurfmutter M 22 x 1,5 - 15 L   Box Nut
	240543	(2x) Überwurfmutter M 26 x 1,5 - 18 L   Box Nut
	36323	(2x) Überwurfmutter M 30 x 2 - 22 L   Box Nut
	255511	(2x) Überwurfmutter M 36 x 2 - 28 L   Box Nut
	70633	(4x) Verschraubung 8 L   Screwing
	40144	(4x) Verschraubung 10 L   Screwing
	21489	(4x) Verschraubung 12 L   Screwing
	36680	(4x) Verschraubung 15 L   Screwing
	70344	(2x) Verschraubung 18 L   Screwing
	70343	(2x) Verschraubung 22 L   Screwing
	70399	(2x) Verschraubung 28 L   Screwing



# Hydraulische Blindkomponenten

## Hydraulic Blanking

Darstellung Illustration	Bauer-Best. Nr. Bauer Item No.	Bezeichnung Description
	240538	(4x) Überwurfmutter M 16 x 1,5 - 8 S   <a href="#">Box Nut</a>
	240540	(4x) Überwurfmutter M 18 x 1,5 - 10 S   <a href="#">Box Nut</a>
	240541	(4x) Überwurfmutter M 20 x 1,5 - 12 S   <a href="#">Box Nut</a>
	11675	(2x) Überwurfmutter M 22 x 1,5 - 14 S   <a href="#">Box Nut</a>
	240542	(4x) Überwurfmutter M 24 x 1,5 - 16 S   <a href="#">Box Nut</a>
	25029	(4x) Überwurfmutter M 30 x 2 - 20 S   <a href="#">Box Nut</a>
	11680	(2x) Überwurfmutter M 36 x 2 - 25 S   <a href="#">Box Nut</a>
	11681	(2x) Überwurfmutter M 42 x 2 - 30 S   <a href="#">Box Nut</a>
	240544	(1x) Überwurfmutter M 52 x 2 - 38 S   <a href="#">Box Nut</a>
		30469
30458		(4x) Verschraubung 10 S   <a href="#">Screwing</a>
30465		(4x) Verschraubung 12 S   <a href="#">Screwing</a>
30750		(2x) Verschraubung 14 S   <a href="#">Screwing</a>
25544		(4x) Verschraubung 16 S   <a href="#">Screwing</a>
30749		(4x) Verschraubung 20 S   <a href="#">Screwing</a>
11514		(2x) Verschraubung 25 S   <a href="#">Screwing</a>
11515		(2x) Verschraubung 30 S   <a href="#">Screwing</a>
11516		(1x) Verschraubung 38 S   <a href="#">Screwing</a>
		235539
	235540	(8x) Verschlusskegel 10 S/L   <a href="#">Locking Cone</a>
	235546	(8x) Verschlusskegel 12 S/L   <a href="#">Locking Cone</a>
	267022	(2x) Verschlusskegel 14 S   <a href="#">Locking Cone</a>
	235538	(4x) Verschlusskegel 15 L   <a href="#">Locking Cone</a>
	14789	(4x) Verschlusskegel 16 S   <a href="#">Locking Cone</a>
	235536	(2x) Verschlusskegel 18 L   <a href="#">Locking Cone</a>
	235543	(4x) Verschlusskegel 20 S   <a href="#">Locking Cone</a>
	267020	(2x) Verschlusskegel 22 L   <a href="#">Locking Cone</a>
	235544	(2x) Verschlusskegel 25 S   <a href="#">Locking Cone</a>
202334	(2x) Verschlusskegel 28 L   <a href="#">Locking Cone</a>	
235541	(2x) Verschlusskegel 30 S   <a href="#">Locking Cone</a>	
235542	(1x) Verschlusskegel 38 S   <a href="#">Locking Cone</a>	

# Hydraulische Blindkomponenten

## Hydraulic Blanking

### SFS – klein | SAE Flange and Blanking Kit – small



\* Die Werte in Klammern sind die im Koffer enthaltenen Stückzahlen.  
 \* Alle Komponenten sind auch einzeln erhältlich.  
 \* The values in brackets are the numbers of items included in the case  
 \* All components are also available separately.

Bauer-ID: 734657

Darstellung Illustration	Bauer-Best. Nr. Bauer Item No.	Darstellung Illustration	Bauer-Best. Nr. Bauer Item No.	Darstellung Illustration	Bauer-Best. Nr. Bauer Item No.
	Bezeichnung Description		Bezeichnung Description		Bezeichnung Description
	58930 (4x) SAE-Flanschkante 1/2", DN 12 SAE-Flange Half		26990 (4x) SAE-Flanschkante 3/4", DN 20 SAE-Flange Half		26988 (4x) SAE-Flanschkante 1", DN 25 SAE-Flange Half
	246939 (16x) Zyl. Schraube mit I-6-kant 1/2" Zyl. Screw with Hexagon		219952 (16x) Zyl. Schraube mit I-6-kant 3/4" Zyl. Screw with Hexagon		237011 (16x) Zyl. Schraube mit I-6-kant 1" Zyl. Screw with Hexagon
	247656 (4x) SAE-Blindteller 1/2" SAE Plate		76758 (4x) SAE-Blindteller 3/4" SAE Plate		76759 (4x) SAE-Blindteller 1" SAE Plate
	211817 (4x) SAE-Verschluss- flansch 1/2" Sealing Flange		211818 (4x) SAE-Verschluss- flansch 3/4" Sealing Flange		211819 (4x) SAE-Verschluss- flansch 1" Sealing Flange
	72680 (50x) – 1/2" 57450 (50x) – 3/4" 45514 (50x) – 1" Dichtung Sealing		259452 (1x) I-6-kant-Einsatz mit Kugelkopf 8 mm Internal Hexagon with Ball Coupling		259453 (1x) I-6-kant-Einsatz mit Kugelkopf 10 mm Internal Hexagon with Ball Coupling

# Hydraulische Blindkomponenten

## Hydraulic Blanking











SFS – mittel – 1 1/4“ | SAE Flange and Blanking Kit – medium – 1 1/4“



- \* Die Werte in Klammern sind die im Koffer enthaltenen Stückzahlen.
- \* Alle Komponenten sind auch einzeln erhältlich.
- \* The values in brackets are the numbers of items included in the case
- \* All components are also available separately.

Bauer-ID: 734678

Darstellung Illustration	Bauer-Best. Nr. Bauer Item No.	Darstellung Illustration	Bauer-Best. Nr. Bauer Item No.	Darstellung Illustration	Bauer-Best. Nr. Bauer Item No.
	Bezeichnung Description		Bezeichnung Description		Bezeichnung Description
	38109 (4x)		211820 (4x)		15315 (2x)
	SAE-Flanshhälfte 1 1/4“, DN 32 SAE-Flange Half		SAE-Verschluss- flansch 1 1/4“ Sealing Flange		SAE-Zwischen- flansch 1 1/4“ Intermediate Flange
	76760 (4x)		57449 (50x)		254741 (8x)
	SAE-Blinderteller 1 1/4“ SAE Plate		Flanschdichtung SAE 1 1/4“, J 518 Flange Sealing		Zyl. Sechskant- mutter 1 1/4“ Hexagon Nut
	246938 (16x)		86390 (8x)		734602 (1x)
	Zyl. Schraube mit I-6-kant 1 1/4“ Zyl. Screw with Hexagon		Zyl. Schraube mit I-6-kant 1 1/4“ Zyl. Screw with Hexagon		I-6-kant-Einsatz mit Kugelkopf 12 mm Internal Hexagon with Ball Coupling









# Hydraulische Blindkomponenten Hydraulic Blanking

**SFS – gross – 1 1/2“ | SAE Flange and Blanking Kit – large – 1 1/2“**



\* Die Werte in Klammern sind die im Koffer enthaltenen Stückzahlen.  
 \* Alle Komponenten sind auch einzeln erhältlich.  
 \* The values in brackets are the numbers of items included in the case  
 \* All components are also available separately.

**Bauer-ID: 734679**

Darstellung Illustration	Bauer-Best. Nr. Bauer Item No.	Darstellung Illustration	Bauer-Best. Nr. Bauer Item No.	Darstellung Illustration	Bauer-Best. Nr. Bauer Item No.
	Bezeichnung Description		Bezeichnung Description		Bezeichnung Description
	38107 (4x)		212543 (4x)		15314 (2x)
	SAE-Flanschhälfte 1 1/2", DN 40 SAE-Flange Half		SAE-Verschluss- flansch 1 1/2" Sealing Flange		SAE-Zwischen- flansch 1 1/2" Intermediate Flange
	76761 (4x)		72736 (50x)		201984 (8x)
	SAE-Blindteller 1 1/2" SAE Plate		Flanschdichtung SAE 1 1/2" Flange Seal		Zyl. Sechskant- mutter 1 1/2" Hexagon Nut
	232180 (16x)		45255 (8x)		734603 (1x)
	Zyl. Schraube mit I-6-kant 1 1/2" Zyl. Screw with Hexagon		Zyl. Schraube mit I-6-kant 1 1/2" Zyl. Screw with Hexagon		I-6-kant-Einsatz mit Kugelkopf 14 mm Internal Hexagon with Ball Coupling

# Service-Koffer-Rack

## Service Case Rack



3-fach Rack für BAUER Service-Koffer  
Rack for up to three BAUER Service Cases  
**Bauer-ID: 850469**

5-fach Rack für BAUER Service-Koffer  
Rack for up to five BAUER Service Cases  
**Bauer-ID: 755972**

Um die praktischen BAUER Service-Koffer fachgerecht und sicher unterzubringen, bieten wir Ihnen hier zwei unterschiedliche Lösungen an: Die 3-fach Version, um bis zu drei BAUER Service-Koffer unterzubringen und die 5-fach Variante für bis zu fünf Koffer.

Das Kofferregal bietet sich als Werkstatt-Ausstattung an, lässt sich aber auch sehr einfach in einem Baustellen- oder Werkstattfahrzeug montieren. Es gibt vielfältige Verwendungsmöglichkeiten.

Die Kofferregale werden ohne die abgebildeten Koffer geliefert.

We are pleased to present you a functional addition to our well known Service Cases: The Case Rack. There are two different versions, one for up to three BAUER Service Cases and another version for up to five BAUER Service Cases.

These racks can be used as a support in any workshop or maybe as an equipment to be fitted in a mechanics/service car. The usage is most versatile.

The racks will be supplied without cases.



**BAUER**  
Service



## Werkzeug und Material Tools and Consumables



### Werkzeuge und Verbrauchsmaterialien Tools and Consumables

· HSE-Equipment HSE Equipment	352 - 353
· Service Diagnosewerkzeug Tool Kit Service Diagnostics	354 - 356
· Werkzeugkoffer Elektrik Tool Kit Electrics	358 - 359
· Werkzeugkoffer Mechanik Tool Kit Mechanics	360 - 361
· Bordwerkzeugsatz Tool Kit Machinery	362 - 365
· Ölnachfülleinheit für BC-Getriebe Oil Refilling Unit for BC Gear	366
· Seilgehänge Lifting Accessories	367 - 368
· Betriebsmittel · Klebe-/Schmierstoffe Supplies · Glue and Lubricants	369 - 370
· Druckluftzubehör Compressed Air Accessories	371 - 373
· Allgemeine Werkzeuge General Tools	374 - 376

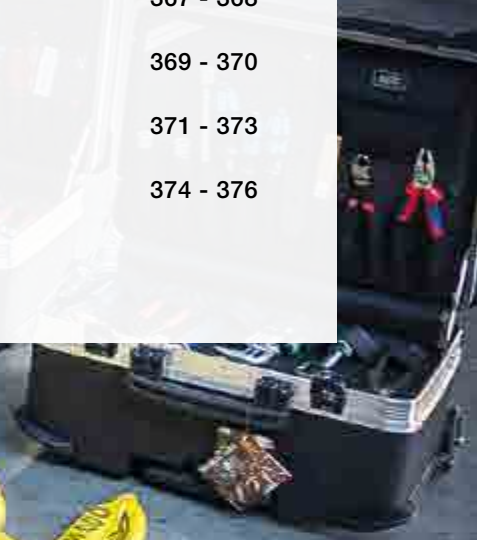



# Werkzeuge und Verbrauchsmaterialien

## Tools and Consumables

### HSE-Equipment | HSE Equipment

















Darstellung Illustration	Bauer-Best.Nr. Bauer Item No.	Bezeichnung Description	
	853787	BAUER HSE Tasche, leer   <a href="#">BAUER HSE Bag, Empty</a>	
	853788	BAUER HSE Tasche mit TSA-Schloss   <a href="#">BAUER HSE Bag with TSA-Lock</a>  Bestehend aus: (1x) Schutzhelm Standard (1x) Handschuhe Spider (1x) Kapselgehörschutz (1x) Warnweste (1x) Atemschutzmaske (1x) Auffanggurt (1x) Fallbegrenzer (1x) Anschlagpunkt – Falldämpfer (2x) Karabinerhaken (2x) Schutzbrillen: (1x) für Brennschneiden (1x) für Trennen/Schleifen	
	Schutzhandschuh Krytech 511 <a href="#">Protective Gloves Krytech 511</a>		
	-	-	
	1349368	Größe 8   <a href="#">Size 8</a>	
	1349369	Größe 9   <a href="#">Size 9</a>	
	1349370	Größe 10   <a href="#">Size 10</a>	
	1349411	Größe 11   <a href="#">Size 11</a>	
	Warnweste gelb <a href="#">Warning Vest Yellow</a>		
	1120003	Größe M   <a href="#">Size M</a>	
	1097701	Größe L   <a href="#">Size L</a>	
	1097702	Größe XL   <a href="#">Size XL</a>	
	1120005	Größe XXL   <a href="#">Size XXL</a>	
Warnweste orange <a href="#">Warning Vest Orange</a>		1120001	Größe M   <a href="#">Size M</a>
		1097703	Größe L   <a href="#">Size L</a>
		1097690	Größe XL   <a href="#">Size XL</a>
		1120002	Größe XXL   <a href="#">Size XXL</a>



# Werkzeuge und Verbrauchsmaterialien

## Tools and Consumables

Darstellung Illustration	Bauer-Best.Nr. Bauer Item No.	Bezeichnung Description
	902512	Schutzhelm Safety Helmet
	1125039	Schutzbrille Brennschneiderarbeiten Safety Goggles Flame-Cutting Work
	390384	Schutzbrille mit farbloser Polycarbonatscheibe Safety Goggles Cutting and Grinding Work
	719967	Schutzbrille Trenn- und Schleifarbeiten Safety Goggles Cutting and Grinding Work
	989458	Schutzbrille Tracker klar Safety Goggles Tracker Clear
	989459	Schutzbrille TRACPSF Safety Goggles TRACPSF
	989460	Optischer Einsatz zur Brille (passend für 989458 und 989459) Optical Insert for Safety Goggles (fits for 989458 and 989459)
	700152	Kapselgehörschutz Ear Muffs Hearing Protection
	385381	Gehörschutzstöpsel Ear Protection Plugs
	400918	Atemschutzmaske Breathing Mask
	751519	Auffanggurt Gr. M/L Safety Harness Size M/L
	751520	Auffanggurt Gr. XL Safety Harness Size XL
	751518	Fallbegrenzer Fall Arrester
	751521	Anschlagpunkt zur Befestigung von Falldämpfern Webbing Strap Anchorage Point
	877821	Karabinerhaken Oval Triple Lock Carabiner
	853789	Erste Hilfe Set First Aid Kit







# Werkzeuge und Verbrauchsmaterialien Tools and Consumables

## Service Diagnosewerkzeug | Tool Kit Service Diagnostics



BAUER Service  
Diagnosewerkzeug-Set  
BAUER Service  
Diagnostic Tool Kit











**Bauer-ID: 780457**

Darstellung Illustration	Bauer-Best.Nr. Bauer Item No.	Bezeichnung Description
	92041	Kombizange Combination Pliers
	966545	Manometer Digital G 1/4", 0 – 700 bar Manometer Digital
	200250	Manometeranschluss Manometer Connection
	1399985	Digitalmultimeter Digital Multimeter
	60045	Magnettester Magnet Testing Tool
	275465	Schraubendreher mit KS-Heft 2 x 50 Screwdriver Plastic Grip

# Werkzeuge und Verbrauchsmaterialien











## Tools and Consumables



Darstellung Illustration	Bauer-Best.Nr. Bauer Item No.	Bezeichnung Description
	92022	Kreuzschraubendreher mit Holzheft 1 x 80 Screwdriver Crosstip Wooden Grip
	230818	L-Stutzen L-Fitting
	230820	L-Stutzen 12 L L-Fitting
	27559	Minimessanschluss Minimess Measurement Connection
	34956	Minimessanschluss DKO 12 L Minimeter Connection
	40144	Rohrverschluss 10 L Pipe Plug
	21489	Rohrverschluss 12 L Pipe Plug
	235540	Verschlusskegel 10 S/L Locking Cone
	235546	Verschlusskegel 12 S/L Locking Cone
	240539	Überwurfmutter M 16 x 1,5 10 L Box Nut

# Werkzeuge und Verbrauchsmaterialien

## Tools and Consumables

Darstellung Illustration	Bauer-Best.Nr. Bauer Item No.	Bezeichnung Description
	11673	Überwurfmutter M 18 x 1,5 12 L Box Nut
	91664	Doppelmaulschlüssel 17 x 19 mm Open-End Wrench
	91667	Doppelmaulschlüssel 20 x 22 mm Open-End Wrench
	389432	Messschieber Sliding Caliper
	459111	Gummischutz für Manometer digital Digital Rubber Cover for Manometer Digital
	27573	Minimessanschluss mit IG 1/4" Minimeter Connection Female Thread
	805012	Maßband Measuring Tape
	609563	Werkzeugtasche "Bauer Service" Tool Bag "Bauer Service"
	805009	Kugelschreiber blau/gelb Pen Yellow/Blue
	456549	Memoblock farbig 7,5 x 14 cm Memo Block Coloured



  
**BAUER**

# Werkzeuge und Verbrauchsmaterialien

## Tools and Consumables

### Werkzeugkoffer Elektrik | Tool Kit Electric



Elektriker-Werkzeugkoffer / Flugkoffer  
(Empfehlung)

Electrician Tool Case / Flightcase  
(Recommendation)

**Bauer-ID: 850077**

Die Werte in Klammern sind die  
im Koffer enthaltenen Stückzahlen.

The value in brackets is the number  
of items included in the case.

Bauer-Best.Nr. Bauer Item No.	Bezeichnung Description
850782	(1x) Werkzeugkoffer rollbar Flightcase, Trolley
849927	(1x) Service Box Steckverbind.sortiment ELO Service Box Pin/Socket Connection
225339	(1x) Abisolierzange 0,5 – 4 mm <sup>2</sup> Wire Stripper
409060	(1x) Crimpzangen-Set 0,5 – 10 mm <sup>2</sup> Crimplier-Set
90038	(1x) Wasserpumpenzange gummiert 250 mm Pliers W. Rubber Covered Handles
92062	(1x) Flachrundzange abgewinkelt Acute Pliers
714999	(1x) Elektroseitenschneider Cutting Nippers (Small)
12793	(1x) Seitenschneider Cutting Nippers (Big)
17449	(1x) Elektronik-Nadelzange Electronic Needle Plier
246649	(1x) Ausdrückwerkzeug Crimp Pushing Tool
246650	(3x) Ersatzdruckhülse Spare Crimp Substitute Husk
966545	(1x) Manometer Digital LEO Manometer Digital Gage
459111	(1x) Gummischutz LEO Rubber Protection

Bauer-Best.Nr. Bauer Item No.	Bezeichnung Description
24324	(2x) Manometeranschluss 1200 mm Manometer Connection
22976	(2x) Manometeranschluss 3200 mm Manometer Connection
27573	(1x) Minimessanschluss Minimeter Connection
390206	Torx-Winkelschraubendreher-Satz 11-tlg. (1x) Star Screw Driver Set 11 pcs.
93105	Sechskantwinkelschraubendreher-Satz 9-tlg. (1x) Screw Driver/Hexagon Key Set 9 pcs.
91160	(1x) Gewindebohrer M 4 Thread Cutter
91161	(1x) Gewindebohrer M 5 Thread Cutter
91162	(1x) Gewindebohrer M 6 Thread Cutter Cutter
92413	(1x) Gewindebohrer M 8 Thread Cutter
91226	(1x) Werkzeughalter Tool Holder
352698	(1x) Schraubendreher 6,5 x 200 mm Screw Driver
90006	(1x) Schraubendreher (2) Screw Driver
90007	(1x) Schraubendreher (1) Screw Driver

# Werkzeuge und Verbrauchsmaterialien

## Tools and Consumables



Bauer-Best.Nr. Bauer Item No.	Bezeichnung Description
351244	(1x) Schraubendreher (0) Screw Driver
275465	(1x) Schraubendreher (00) Screw Driver
70922	(1x) Schraubendreher vollisoliert (4) Full Isolated Screw Driver
90010	(1x) Schraubendreher vollisoliert (3) Full Isolated Screw Driver
90009	(1x) Schraubendreher vollisoliert (2) Full Isolated Screw Driver
70918	(1x) Schraubendreher vollisoliert (0) Full Isolated Screw Driver
92020	(1x) Kreuzschlitzschraubendreher (0) Cross Screw Driver
14685	(1x) Kreuzschlitzschraubendreher (1) Cross Screw Driver
14686	(1x) Kreuzschlitzschraubendreher (2) Cross Screw Driver
78388	(1x) Schraubendreher kurz 1 x 6,5 Short Screw Driver
78402	(1x) Schraubendreher kurz 1,2 x 8 Short Screw Driver
59057	(1x) Kreuzschlitzschraubendreher kurz (0) Short Screw Driver Cross
59058	(1x) Kreuzschlitzschraubendreher kurz (1) Short Screw Driver Cross
59059	(1x) Kreuzschlitzschraubendreher kurz (2) Short Screw Driver Cross
848228	(1x) Sechskantschraubendreher (2,5) Hexagon Socket Screw
848229	(1x) Sechskantschraubendreher (3) Hexagon Socket Screw
848230	(1x) Sechskantschraubendreher (4) Hexagon Socket Screw
848241	(1x) Sechskantschraubendreher (5) Hexagon Socket Screw
225337	(1x) Jokari Abmantelmesser 4 -16 mm Jokari Cable Stripping Knife

Bauer-Best.Nr. Bauer Item No.	Bezeichnung Description
91887	(1x) Steckschlüssel Satz Wrench Set
59065	(1x) Rollgabelschlüssel 19 mm Wrench
60045	(1x) Magnettester Magnet Testing Tool
60154	(1x) Prüflampe 24 V Test Lamp
1399985	(1x) Digitalmultimeter Digital Multimeter
66107	(1x) Prüfkabel rot 1,5 m Measuring Cable Red
66106	(1x) Prüfkabel schwarz 1,5 m Measuring Cable Red
225341	(1x) Prüfspitzen schwarz Test Pin Black
225342	(1x) Prüfspitzen rot Test Pin Red
66108	(1x) Abgreifklemme schwarz Crocodile Clip Black
66109	(1x) Abgreifklemme rot Crocodile Clip Red
86464	(1x) Klemmprüfspitzen Clamp-Type Test
86463	(1x) Klemmprüfspitzen Clamp-Type Test
836036	(1x) LötKolben 24 V Piston
55307	(1x) Fluitin Lötdraht Ø 1 mm, 60 % Zinngehalt Filler Wire 60 % Tin Content
92130	(1x) Körner 120/10 Punch
91470	(1x) Kunststoffgliedermaß Plastic Ruler
356763	(1x) Rollpresszange Tongs

# Werkzeuge und Verbrauchsmaterialien

## Tools and Consumables

### Werkzeugkoffer Mechanik | Tool Kit Mechanics



Mechaniker-Werkzeugkoffer / Flugkoffer  
(Empfehlung)

Mechanic Tool Case / Flightcase  
(Recommendation)

**Bauer-ID: 850078**

Die Werte in Klammern sind die im Koffer enthaltenen Stückzahlen.

The value in brackets is the number of items included in the case.

Bauer-Best.Nr. Bauer Item No.	Bezeichnung Description
850782	(1x) Werkzeugkoffer, rollbar Flightcase, Trolley
92053	(1x) Wasserpumpenzange gummiert 250 mm Pliers W. Rubber Covered Handles
92041	(1x) Kombizange Multi-Purpose Pliers
92050	(1x) Rabetzange Nippers
92091	(1x) Seitenschneider Wire Cutter
93709	(1x) Splintreiber (Sonderqualität) 10 mm Pin Punch (Special Premium)
92127	(1x) Splintreiber 8 mm, CV, DIN 6450C Pin Punch
92107	(1x) Flachmeißel 200 mm, CV, DIN 6453 Chisel
90097	(1x) Schlagringschlüssel 46 mm Sledge Hammer Wrench
91800	(1x) Schlagringschlüssel 50 mm Sledge Hammer Wrench
355346	(1x) Doppelpmaulschlüssel-Satz 13-tlg. Open-Ended Wrench Set 13 pcs.
91702	(1x) Einmaulschlüssel 46 mm Open-Ended Wrench
485068	(1x) Doppelringschlüssel-Satz 12-tlg. Double Box Wrench Set 12 pcs.

Bauer-Best.Nr. Bauer Item No.	Bezeichnung Description
92208	(1x) Bandschlüssel 285 mm Strap Wrench
259453	(1x) Innensechskanteinsatz 1/2", 10 mm mit Kugelkopf Hexagon Bit with Ballhead
259452	(1x) Innensechskanteinsatz 1/2", 8 mm mit Kugelkopf Hexagon Bit with Ballhead
352834	(1x) Sechskantwinkelschraubendreher 12 mm Screw Driver/Hexagon Key
352835	(1x) Sechskantwinkelschraubendreher 14 mm Screw Driver/Hexagon Key
91830	(1x) Sechskantwinkelschraubendreher 12 mm Screw Driver/Hexagon Key
91831	(1x) Sechskantwinkelschraubendreher 14 mm Screw Driver/Hexagon Key
91832	(1x) Sechskantwinkelschraubendreher 17 mm Screw Driver/Hexagon Key
93105	(1x) Sechskantwinkelschraubendreher-Satz 9-tlg   Screw Driver/Hexagon Key Set 9 pcs.
390206	(1x) Torx-Winkelschraubendreher-Satz 11-tlg. Star Screw Driver Set 11 pcs.
356719	(1x) Schraubendreher-Satz 3-tlg. Pozidriv (Gr.1,2,3)   Pozidriv Screw Driver Set 3 pcs.



# Werkzeuge und Verbrauchsmaterialien

## Tools and Consumables











Bauer-Best.Nr. Bauer Item No.	Bezeichnung Description
93761	(1x) Schraubendreher-Satz 6-tlg. Schlitz <a href="#">Slot Screw Driver Set</a>
49607	(1x) Hydraulikgreifkupplung (Fettpressenaufsatz für Kettenspannventil) <a href="#">Hydraulik Coupling (Grease Pump Adapte for Crawler Tensioning Valve)</a>
50500	Ölablassschlauch 0,25 m, 90°, M 26 x 1,5 (1x) <a href="#">Oil Drain Adapter 90° with Hose</a>
360172	Ölablassschlauch 0,25 m, 90°, M 22 x 1,5 (1x) <a href="#">Oil Drain Adapter 90° with Hose</a>
30856	(1x) Manometer 10 bar, G 1/4   <a href="#">Manometer</a>
20394	(1x) Manometer 60 bar, G 1/4   <a href="#">Manometer</a>
26603	(1x) Manometer 400 bar, G 1/4   <a href="#">Manometer</a>
24324	(2x) Manometeranschluss-Schlauch 1500 mm <a href="#">Manometer Connection Hose</a>
27573	(3x) Minimesanschluss 1/4" IG <a href="#">Minimeter Connection, Female Thread</a>
91916	(1x) Knarre 1/2" <a href="#">Ratchet</a>
91918	(1x) Verlängerung 1/2", 130 mm <a href="#">Extension</a>
91919	(1x) Verlängerung 1/2", 255 mm <a href="#">Extension</a>
91921	(1x) Kardangelenk 1/2" <a href="#">Joint</a>
479074	(2x) Clip-Leiste 1/2" <a href="#">Clip-Keeper</a>
78947	(1x) Zwölfkanteinsatz 1/2", 10 mm <a href="#">Bi-Hexagon Bit</a>
92453	(1x) Zwölfkanteinsatz 1/2", 11 mm <a href="#">Bi-Hexagon Bit</a>
91922	(1x) Zwölfkanteinsatz 1/2", 13 mm <a href="#">Bi-Hexagon Bit</a>
92451	(1x) Zwölfkanteinsatz 1/2", 15 mm <a href="#">Bi-Hexagon Bit</a>
91923	(1x) Zwölfkanteinsatz 1/2", 17 mm <a href="#">Bi-Hexagon Bit</a>

Bauer-Best.Nr. Bauer Item No.	Bezeichnung Description
91924	(1x) Zwölfkanteinsatz 1/2", 19 mm <a href="#">Bi-Hexagon Bit</a>
92449	(1x) Zwölfkanteinsatz 1/2", 22 mm <a href="#">Bi-Hexagon Bit</a>
78450	(1x) Zwölfkanteinsatz 1/2", 24 mm <a href="#">Bi-Hexagon Bit</a>
92448	(1x) Zwölfkanteinsatz 1/2", 27 mm <a href="#">Bi-Hexagon Bit</a>
92447	(1x) Zwölfkanteinsatz 1/2", 30 mm <a href="#">Bi-Hexagon Bit</a>
72124	(1x) Innensechskanteinsatz 1/2", 4 mm <a href="#">Hexagon Bit</a>
72125	(1x) Innensechskanteinsatz 1/2", 5 mm <a href="#">Hexagon Bit</a>
72128	(1x) Innensechskanteinsatz 1/2", 8 mm <a href="#">Hexagon Bit</a>
72129	(1x) Innensechskanteinsatz 1/2", 10 mm <a href="#">Hexagon Bit</a>
91926	(1x) Innensechskanteinsatz 1/2", 12 mm <a href="#">Hexagon Bit</a>
92472	(1x) Innensechskanteinsatz 1/2", 14 mm <a href="#">Hexagon Bit</a>
92473	(1x) Innensechskanteinsatz 1/2", 17 mm <a href="#">Hexagon Bit</a>
92424	(1x) Innensechskanteinsatz 1/2", 19 mm <a href="#">Hexagon Bit</a>
57450	(10x) Flanschdichtung SAE 3/4", J 518 <a href="#">Flange Sealing</a>
45514	(10x) Flanschdichtung SAE 1", J 518 <a href="#">Flange Sealing</a>
57449	(20x) Flanschdichtung SAE 1 1/4", J 518 <a href="#">Flange Sealing</a>
22947	(2x) Fluiflexband <a href="#">Fluiflex Band</a>
30454	(3x) Kegelschmiernippel M 10 x 1 <a href="#">Grease Nipple</a>
20872	(3x) Kegelschmiernippel M 10 x 1, 90° <a href="#">Grease Nipple</a>

# Werkzeuge und Verbrauchsmaterialien

## Tools and Consumables













### Bordwerkzeugsatz | Tool Kit Machinery

1089989 Bauer Standardwerkzeug kpl.   Bauer Standard Tools cpl.		
Darstellung Illustration	Bauer-Best.Nr. Bauer Item No.	Bezeichnung Description
	46728	Stahlblech-Werkzeugkasten 5-tlg., L: 530 mm Sheet Steel Toolbox 5 Pcs.
	91700	Einmaulschlüssel 36 mm Open-End Wrench
	91701	Einmaulschlüssel 41 mm Open-End Wrench
	91702	Einmaulschlüssel 46 mm Open-End Wrench
	90116	Einmaulschlüssel 50 mm Open-End Wrench
	90117	Einmaulschlüssel 55 mm Open-End Wrench
	90118	Einmaulschlüssel 60 mm Open-End Wrench
	91832	Sechskantwinkelschraubendreher 17 mm Screw Driver, Hexagon Key
	91833	Sechskantwinkelschraubendreher 19 mm Screw Driver, Hexagon Key
	92202	Leichte Kettenrohrzange 3/8 - 4" Light Chain Pipe Wrench
	355346	Doppelmaulschlüssel-Satz 13-tlg. Open-end Wrench Set

# Werkzeuge und Verbrauchsmaterialien











## Tools and Consumables



Darstellung Illustration	Bauer-Best.Nr. Bauer Item No.	Bezeichnung Description
	92050	Monierzange atramentiert 280 mm Nippers
	367105	Schlosserhammer 1kg Engineer's Hammer
	93105	Sechskantwinkelschraubendreher-Satz 9-tlg. Screw Driver, Hexagon Key Set 9 pcs.
	92053	Wasserpumpenzange atramentiert 250 mm Pliers W. Rubber Covered Handles
	93749	Bandschlüssel 20/600 Ribbon Wrench
	352834	Sechskantwinkelschraubendreher Kugelkopf 12 Screw Driver, Hexagon Key, Key Ball End
	352835	Sechskantwinkelschraubendreher Kugelkopf 14 Screw Driver, Hexagon Key, Key Ball End
	92148	Vorschlaghammer 4 kg mit Fiberglas Stiel Sledge Hammer with Fiberglass Handle
	92125	Splintreiber 6 mm Pin Punch
	485068	Doppelringschlüssel-Satz 12-tlg. Double Box Wrench Set
	92041	Kombizange Combination Pliers
	661188	Schraubendreher-Sortiment Screw Extractor

# Werkzeuge und Verbrauchsmaterialien

## Tools and Consumables









Darstellung Illustration	Bauer-Best.Nr. Bauer Item No.	Bezeichnung Description
	92107	Flachmeißel L: 125, B: 16 Chisel L: 125, W: 16
	92127	Splinttreiber 8 mm Pin Punch
	92120	Splinttreiber 10 mm Pin Punch
	1190311	Hakenschlüssel mit Zapfen 8 mm Hook Spanner with Pin
<b>Zusatzwerkzeuge   Additional Tools</b>		
Darstellung Illustration	Bauer-Best.Nr. Bauer Item No.	Bezeichnung Description
	91836	Sechskantwinkelschraubendreher 22 mm Screw Driver, Hexagon Key
	111783	Bolzenausziehvorrichtung M 20 + M 30 kpl. Pin Extractor cpl.
	393057	Montagewerkzeug für Hyd. Kupplungen Baugröße 8 und 10 Assembly Tool for Hyd. Coupling Size 8 and 10
	1286154	Rohrsteckschlüssel 18 x 21, L: 160 Tubular Box Wrench
	90057	Stahldrahthandbürste Wire Brush
	92236	Dreikanthohlschaber Three-square Hollow Scraper
	92112	Nageleisen 600 mm Pry Bar 600mm

Passende Werkzeugausstattung für die verschiedenen Gerätetypen sind auf Anfrage erhältlich.  
Tool sets suiting for the various machine types are available on request.

# Werkzeuge und Verbrauchsmaterialien

## Tools and Consumables



Darstellung Illustration	Bauer-Best.Nr. Bauer Item No.	Bezeichnung Description
	242057	HD Zweihandpresse mit Gummischlauch HD Two Lever Grease Dispenser with Hose
	49607	Kupplung für Flachschiernippel Coupling for Flat Grease Nippel
	1027550	Handleuchte 6 - 24 V Hand Lamp
	50500	Ölablassschlauch 90°, M 26 x 1,5 L: 0,25 m Oil Drain Adapter Hose
	942421	Schlagringschlüssel 41 mm Solgging Ring Spanner
	623546	Schlagringschlüssel 46 mm Solgging Ring Spanner
	1086192	Schlagringschlüssel 50 mm Solgging Ring Spanner
	1086193	Schlagringschlüssel 55 mm Solgging Ring Spanner
	402820	Zurrurgurt kpl. L: 4000, B: 35 Clamping Band cpl. L: 4000, W: 35
	205413	Bolzen 60 - 316 MB, s+b Pin
	305148	U-Sicherungsstift für Ø 60 mm U-Safety Pin

Passende Werkzeugausstattung für die verschiedenen Gerätetypen sind auf Anfrage erhältlich.  
Tool sets suiting for the various machine types are available on request.

# Werkzeuge und Verbrauchsmaterialien

## Tools and Consumables

### Ölnachfülleinheit für BC-Getriebe | Oil Refilling Unit for BC Gear

Bauer-ID: 55011



- \* Die Werte in Klammern sind die im Koffer enthaltenen Stückzahlen.
- \* Alle Komponenten sind auch einzeln erhältlich.
- \* The values in brackets are the numbers of items included in the case
- \* All components are also available separately.





Ölnachfülleinheit   Oil Refilling Unit		
Darstellung Illustration	Bauer-Best.Nr. Bauer Item No.	Bezeichnung Description
	464155	(1x) Getriebeölpumpe kpl. mit 3 m HD-Schlauch Gearoil Pump cpl. with HD-Hose
	61469	(1x) Ölpumpen-Adapter M 10 x 1 Adapter Oil Pump
	34633	(4x) Fluidtechnik-O-Ring 10 x 3 Fluid Power System-O-Ring
	19984	(1x) Adapter R 3/8, blau Adapter Blue
	61468	(1x) Adapter M 16 x 1,5 gelb Adapter Yellow
	112983	(1x) Adapter M 24 x 1,5 grün Adapter Green



# Werkzeuge und Verbrauchsmaterialien



## Tools and Consumables

### Seilgehänge | Lifting Accessories

Anschlagseil   Slings Rope				
Darstellung Illustration	Bauer-Best.Nr. Bauer Item No.	0° - 45°	45° - 60°	Länge (m) Length (m)
	15331	6 to	4,25 to	2
	17818	12,6 to	9 to	2,5
	17894	10 to	7,5 to	2,5
	50171	8,5 to	6 to	2
Hebelzug, Flaschenzug, Ankerschäkel   Lever Pull Wire, Pulley Block, Shackle				
Darstellung Illustration	Bauer-Best.Nr. Bauer Item No.	Bezeichnung Description		
	61782	Hebelzug 0,75 to Lever Pull Wire		
	985258	Hebelzug 1,5 to Lever Pull Wire		
	880189	Flaschenzug 0,5 to Pulley Block		
	947132	Flaschenzug 2 to Pulley Block		
	700940	Ankerschäkel 6,5 to Shackle		
	700941	Ankerschäkel 8,5 to Shackle		
	265329	Ankerschäkel 13,5 to Shackle		
	54208	Ankerschäkel 17 to Shackle		
	54209	Ankerschäkel 25 to Shackle		
	50483	Ankerschäkel 35 to Shackle		
	259712	Ankerschäkel 55 to Shackle		

# Werkzeuge und Verbrauchsmaterialien

## Tools and Consumables

Hebebänder   Webbing Slings		
Darstellung Illustration	Bauer-Best.Nr. Bauer Item No.	Bezeichnung Description
  	1019482	Hebeband endlos, 1 m, max. 1000 kg Webbing Sling, Endless
	730300	Hebeband endlos, 1,5 m, max. 3000 kg Webbing Sling, Endless
	951594	Hebeband endlos, 3 m, max. 3000 kg Webbing Sling, Endless
	235002	Hebeband endlos, 4 m, max. 3000 kg Webbing Sling, Endless
	225605	Hebeband 2-lagig, 1,5 m, mit Schlaufe, max. 3000 kg Two-Layer Webbing Sling, with Straps
	239094	Hebeband 2-lagig, 1,5 m, mit Schlaufe, max. 1000 kg Two-Layer Webbing Sling, with Straps
	225606	Hebeband 2-lagig, 3 m, mit Schlaufe, max. 3000 kg Two-Layer Webbing Sling, with Straps
	261114	Hebeband 2-lagig, 3 m, mit Schlaufe, max. 1000 kg Two-Layer Webbing Sling, with Straps
	515387	Polytex Hebeband endlos, 4 m Polytex Sling Band



# Werkzeuge und Verbrauchsmaterialien

## Tools and Consumables









### Betriebsmittel • Klebe-/Schmierstoffe | Supplies • Glue and Lubricants



Bauer-Best.Nr. Bauer Item No.	Bezeichnung Description
229973	Loctite 243 Schraubensicherung mittelfest, 10 ml   <a href="#">Threadlocker, Medium Strength</a>
60466	Loctite 243 Schraubensicherung mittelfest, 50 ml   <a href="#">Threadlocker, Medium Strength</a>
56574	Loctite 243 Schraubensicherung mittelfest, 250 ml   <a href="#">Threadlocker, Medium Strength</a>
245862	Loctite 245 Schraubensicherung mittelfest, 50 ml   <a href="#">Threadlocker, Medium Strength</a>
429201	Loctite 270 Schraubensicherung hochfest, 10 ml   <a href="#">Threadlocker, High Strength</a>
23557	Loctite 270 Schraubensicherung hochfest, 50 ml   <a href="#">Threadlocker, High Strength</a>
266903	Loctite 270 Schraubensicherung hochfest, 250 ml   <a href="#">Threadlocker, High Strength</a>
900723	Loctite 275 Schraubensicherung hochfest, 50 ml   <a href="#">Threadlocker, High Strength</a>
30808	Loctite 401 Sekundenkleber 5 g   <a href="#">CA Glue</a>
901328	Loctite 401 Sekundenkleber 50 g   <a href="#">CA Glue</a>
901244	Loctite 573 Flächendichtung 50 g   <a href="#">Flange Sealant</a>
353462	Loctite 574 Flächendichtung 50 g   <a href="#">Flange Sealant</a>
86157	Loctite 574 Flächendichtung 250 g   <a href="#">Flange Sealant</a>
76177	Loctite 586 Gewindedichtung 50 g   <a href="#">Thread Sealant</a>
96800	Loctite 586 Gewindedichtung 250 g   <a href="#">Thread Sealant</a>
39272	Loctite 638 Fügen Welle-Nabe 50 g   <a href="#">Retaining Compound</a>
88617	Loctite 640 Fügen Welle-Nabe langsam härtend, 50 g   <a href="#">Retaining Compound, Slow Curing</a>
60525	Loctite 641 Fügen Welle-Nabe mittelfest, 50 g   <a href="#">Retaining Compound, Medium Strength</a>
365916	Loctite 5926 Flächendichtung 100 g   <a href="#">Blue Silicon Gasket</a>
1284991	Rostlöser   <a href="#">Rust Dissolver</a>
1147708	Schnellreiniger   <a href="#">Fast Cleaner</a>

# Werkzeuge und Verbrauchsmaterialien

## Tools and Consumables







Darstellung Illustration	Bauer-Best.Nr. Bauer Item No.	Bezeichnung Description
<b>Schmierfett für statische Lagerung (nicht geeignet für Zentralschmieranlage)</b> <b>Grease for Static Bearing Lubrication (not suitable for central lubrication systems)</b>		
	241882	Langzeit EP-Fett, wasserbeständig, 0,5 kg, Kartusche Long Life-EP Grease, Water Resistant, Cartridge
	362644	Langzeit EP-Fett, wasserbeständig, 5 kg Eimer Long Life-EP Grease, Water Resistant, Bucket
<b>Schmierfett für dynamische Lagerung/Zentralschmierung   Grease for Dynamic Bearing / Central Lubrication</b>		
	241884	Fett, 0,4 kg, Tube Grease, Tube
	373373	Fett, 0,5 kg, Kartusche Grease, Cartridge
	373374	Fett, 18 kg, Eimer Grease, Bucket
	394891	Fließfett, wasserbeständig, 5 kg, Eimer Semi Fluid-Water Resistant Grease, Bucket
	934219	Fließfett, wasserbeständig, 25 kg, Eimer Semi Fluid-Water Resistant Grease, Bucket
<b>Schmierfett für offene Verzahnung   Grease for Open Gearing</b>		
	1024219	Schmierfett 0,3 kg, Kartusche Heavy Duty Grease, Cartridge
	700851	Fett-Spray für offene Getriebe, 0,4 l Heavy Duty Grease-Spray, Can
<b>Hilfsmittel   Accessories</b>		
	377471	Befüllpresse für Zentralschmierung (BG, MC) Filling Gun for Central Lubrication (BG, MC)
	477926	Befüllpresse für Zentralschmierung (RG, RM) Filling Gun for Central Lubrication (RG, RM)



# Werkzeuge und Verbrauchsmaterialien





## Tools and Consumables

### Druckluftzubehör | Compressed Air Accessories

Darstellung Illustration	Bauer-Best.Nr. Bauer Item No.	Bezeichnung Description
<b>Kupplung   Coupling</b>		
	279639	Pneumatik Schnellverschlusskupplung 1/4" AG Pneumatic Quick Coupling 1/4" External Thread
	43734	Pneumatik Schnellverschlusskupplung 3/8" AG Pneumatic Quick Coupling 3/8" External Thread
	72596	Pneumatik Schnellverschlusskupplung 1/2" AG Pneumatic Quick Coupling 1/2" External Thread
	72597	Pneumatik Schnellverschlusskupplung 1/4" IG Pneumatic Quick Coupling 1/4" Internal Thread
	43733	Pneumatik Schnellverschlusskupplung 3/8" IG Pneumatic Quick Coupling 3/8" Internal Thread
	72598	Pneumatik Schnellverschlusskupplung 1/2" IG Pneumatic Quick Coupling 1/2" Internal Thread
<b>Stecktüllen   Plug Sockets</b>		
	217270	Pneumatik Stecknippel LW 6 Pneumatic Nipple
	22990	Pneumatik Schlauchanschluss LW 6 Pneumatic Hose
<b>Stecknippel   Nipple</b>		
	279601	Pneumatik Stecknippel 1/4" AG Pneumatic Nipple 1/4" External Thread
	86606	Pneumatik Stecknippel 3/8" AG Pneumatic Nipple 3/8" External Thread
	279602	Pneumatik Stecknippel 1/4" IG Pneumatic Nipple 1/4" Internal Thread
	22986	Pneumatik Stecknippel 3/8" IG Pneumatic Nipple 3/8" Internal Thread
	22947	Fluiflexband 12,5 m x 12,5 mm x 0,07 mm Fluiflex Band

# Werkzeuge und Verbrauchsmaterialien





## Tools and Consumables

Darstellung Illustration	Bauer-Best.Nr. Bauer Item No.	Bezeichnung Description
Schlauchklemmen   <a href="#">Hose Clamp</a>		
	36856	Schlauchklemme 7 - 9 mm   <a href="#">Clamp</a>
	36858	Schlauchklemme 9 - 11 mm   <a href="#">Clamp</a>
	36855	Schlauchklemme 11 - 13 mm   <a href="#">Clamp</a>
	36857	Schlauchklemme 13 - 15 mm   <a href="#">Clamp</a>
	36854	Schlauchklemme 15 - 17 mm   <a href="#">Clamp</a>
	36853	Schlauchklemme 16 - 18 mm   <a href="#">Clamp</a>
	36860	Schlauchklemme 20 - 23 mm   <a href="#">Clamp</a>
	36859	Schlauchklemme 23 - 27 mm   <a href="#">Clamp</a>
	36863	Schlauchklemme 25 - 28 mm   <a href="#">Clamp</a>
	36864	Schlauchklemme 27 - 31 mm   <a href="#">Clamp</a>
	36862	Schlauchklemme 31 - 34 mm   <a href="#">Clamp</a>
	36861	Schlauchklemme 34 - 37 mm   <a href="#">Clamp</a>
Verteiler und Zubehör   <a href="#">Distributors and Accessories</a>		
	22985	Pneumatik-Y-Verteiler 3/8" <a href="#">Pneumatic-Y-Distributor</a>
	696030	Pneumatik-Y-Verteiler 1/2" <a href="#">Pneumatic-Y-Distributor</a>
	658770	Pneumatik-Y-Verteiler 1/4" <a href="#">Pneumatic-Y-Distributor</a>
	72599	Pneumatik Blaspistole <a href="#">Pneumatic Blow Pistol</a>
	21436	Pneumatik Blaspistole mit Stecknippel <a href="#">Pneumatic Blow Pistol with Nipple</a>

# Werkzeuge und Verbrauchsmaterialien

## Tools and Consumables









Darstellung Illustration	Bauer-Best.Nr. Bauer Item No.	Bezeichnung Description
	72600	Verlängerungseinsätze für Pistole 100 mm Extension for Spraygun
	72601	Verlängerungseinsätze für Pistole 250 mm Extension for Spraygun
	887516	Schlauchaufrollvorrichtung Hose Reel
	865626	Schlauchaufrollvorrichtung für Schlauchlänge 15 m bis max. 45 bar, DN 20 – 3/4" Hose Reel for Hose Length 15 m until max. 45 bar
	354951	Hydraulikkompressor Piston Compressor
	387336	Luftwendel Spiral

# Werkzeuge und Verbrauchsmaterialien

## Tools and Consumables

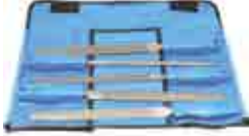







### Allgemeine Werkzeuge | General Tools

Darstellung Illustration	Bauer-Best.Nr. Bauer Item No.	Bezeichnung Description
	92595	Steckschlüsselsatz 46 - 80 mm Socket Set
	433446	Steckschlüssel-Set 1/4" Vierkant Socket Set 1/4" Square
	622901	Werkzeugsortiment Tool Set
	630984	Werkzeugsortiment VDE-isoliert Tool Set VDE-Insulated
	838733	Steckschlüsselset 1/4" und 1/2" Vierkant Socket Set 1/4" and 1/2" Square
	91530	Feilenset File Set
	849331	Torx-Schlüsselsatz Torx Key Set

# Werkzeuge und Verbrauchsmaterialien



## Tools and Consumables



Darstellung Illustration	Bauer-Best.Nr. Bauer Item No.	Bezeichnung Description
	450722	Sechskantschlüsselsatz Allen Key Set
	78393	Splinttreiberset Punch Set
	93934	Durchschlägerset Punch Set
	93695	Spiralbohrersatz Drill Set
	849336	Leatherman „Wave“ Leatherman „Wave“
	849332	Ölfiterkralle Oil Filter Claw
	849362	LED-Taschenlampe LED Lamp
	444999	Adapter für Bolzenauszieher M 30 auf M 24 Reduction for Pin Extractor M 30 to M 24

# Werkzeuge und Verbrauchsmaterialien

## Tools and Consumables

Darstellung Illustration	Bauer-Best.Nr. Bauer Item No.	Bezeichnung Description
	59826	Plastiköler Plastic Oiler
	6865	Messbecher 0,25 l   Measuring Jug
	701064	Messbecher 1 l   Measuring Jug
	701065	Messbecher 2 l   Measuring Jug
	701085	Messbecher 3 l   Measuring Jug
	75166	Messbecher 5 l   Measuring Jug
	701066	Kanne 1 l   Can
	701067	Kanne 2 l   Can
	59291	Trichter Ø 80 mm   Funnel
	59289	Trichter Ø 120 mm   Funnel
	59288	Trichter Ø 160 mm   Funnel
	59287	Trichter Ø 200 mm   Funnel
	701063	Trichter Ø 250 mm   Funnel
	382010	Trichter oval mit Sieb   Funnel Oval with Sieve
	59292	Trichter mit Flex Auslauf   Funnel with Flexible Discharge Pipe
	48482	Eimer, Plastik   Plastic Bucket
228450	Mörtelkasten   Mortar Trough	
-	955025	Ölförderpumpe   Oil Pump
-	955027	Deckel   Cover
-	955029	Behälter 10 l   Box



## Service- und Maintenance-Container *Service and Maintenance Container*

Lassen Sie sich ein individuelles Angebot bezüglich der Werkzeugausstattung Ihres Service und Maintenance Containers unterbreiten. Kontaktieren Sie uns unter [BMA-Parts-and-Service@bauer.de](mailto:BMA-Parts-and-Service@bauer.de).

### Beispielausstattung:

- 10 Fuß, 20 Fuß oder 40 Fuß mit Doppelflügeltür
- Sonderdiebstahlsicherung mit Zylinderschloss
- CSC-Plakette
- Elektroinstallation und Beleuchtung
- Regale oder Schränke
- Schubladenrollschränke
- Werkbank (verschraubt/mobil) und -Schraubstock
- Kranschiene, Flaschenhalter, Zurrösen
- Maschinen- oder projektspezifische Werkzeugauswahl
- Hydraulik-Schlauchpressausrüstung
- Kompressor, (Schweiß-)Generator
- Ersatzteile, Verschraubungen u. v. m.

*Let us submit an individual offer regarding tools and equipment for your service and maintenance container. Contact us under [BMA-Parts-and-Service@bauer.de](mailto:BMA-Parts-and-Service@bauer.de).*

### Sample features:

- 10 feet, 20 feet or 40 feet with double wing door
- Special theft protection with cylinder lock
- CSC badge
- Electric installation and lighting
- Racks or cabinets
- Cabinets with roller drawers
- Workbench (fixed/rolling) and vice
- Crane rail, bottle holders, lashings
- Rig or project specific tools, special tool range
- Hydraulic hose press equipment
- Compressor, (welding) generator
- Spare parts, fittings, ...



Merchandising  
Merchandising







Merchandising-Produkte  
Merchandising Products

380 - 381



# Merchandising Merchandising















Darstellung Illustration	Bezeichnung Description	Maßstab Scale
	<p>RG 21 T mit Hydraulikrüttler with Hydraulic Vibrator</p>	
	<p>GB 50 Hydraulischer Greifer Hydraulic Gripper</p>	
	<p>MC96 + BC35 + HDS-T</p>	1:50
	<p>BG 28 H</p>	
	<p>BCS 185</p>	

Diese und noch mehr Modelle und Merchandising-Produkte können im Bauer-Shop bestellt werden: [www.bauer-products.de](http://www.bauer-products.de)  
 All of these and many other merchandising products can be ordered through our online shop [www.bauer-products.de](http://www.bauer-products.de)

# Merchandising

## Merchandising



Darstellung Illustration	Größe Size	Darstellung Illustration	Größe Size
	Jacke wetterfest von Schöffel  Jacket Wheater Proof by Schöffel		Jacke Clearwater, dunkelblau von Schöffel  Jacket Clearwater, Dark Blue by Schöffel
	Sauna-Tuch, dunkelblau von Möve  Towel, Dark Blue by Möve		Jacke Zweijahreszeiten, schwarz von Schöffel  Two Seasons Jacket, Black by Schöffel
	Umhängetasche grau  Shoulder Bag Grey		Softshelljacke Damen, schwarz von Engelbert Strauss  Softshell Jacket, Ladies, Black by Engelbert Strauss
	Fußball  Football		Softshelljacke Herren, schwarz von Engelbert Strauss  Softshell Jacket, Gentlemen, Black by Engelbert Strauss
	Carrybag dunkelblau von Reisetel  Carrybag Dark Blue by Reisetel		Polo-Shirts, blau für Damen und Herren  Polo Shirts, Blue for Men and Women
	Powerbank weiß  Powerband White		BAUER-Cap blau  BAUER Caps Blue
	Zippo-Feuerzeug  Zippo Lighter		Multicase schwarz von Reisetel  Multicase Black by Reisetel

Diese und noch mehr Modelle und Merchandising-Produkte können im Bauer-Shop bestellt werden: [www.bauer-products.de](http://www.bauer-products.de)  
 All of these and many other merchandising products can be ordered through our online shop [www.bauer-products.de](http://www.bauer-products.de)





## International Service Hotline

*We follow the sun*

**+800 1000 1200\***

**+49 8252 97-2888**  
**BMA-Service@bauer.de**

\*toll-free number, where available

Um eine schnelle Hilfe zu gewährleisten, stehen Ihnen englischsprachige und temporär auch deutschsprachige Ansprechpartner zur Verfügung. Wir bieten Ihnen technischen Support sowie Ersatzteillieferungen bei Maschinenstillstand in Notfällen, auch außerhalb der Geschäftszeiten. Ausfallkosten und Baustellenstillstände lassen sich somit erheblich reduzieren.

*To ensure quick assistance, there are English speaking and temporarily German speaking contact partners available. We offer technical support and spare parts delivery during machine breakdown in urgent cases, subject to processing fee. Breakdown costs and stand stills at the sites can herewith be reduced significantly.*

**24/7**





BAUER Maschinen GmbH  
BAUER-Strasse 1  
86529 Schrobenhausen  
Germany  
Phone: +49 8252 97-0  
[bma-parts-and-service@bauer.de](mailto:bma-parts-and-service@bauer.de)  
[www.bauer.de](http://www.bauer.de)

Die Materialien und Spezifikationen können ohne vorherige Ankündigung geändert werden. Die Abbildungen enthalten möglicherweise optionale Ausstattungen und zeigen nicht alle möglichen Konfigurationen. Diese Angaben und die technischen Daten dienen als Anhaltspunkte. Irrtümer und Druckfehler sind vorbehalten.

Materials and specifications are subject to change without notice. Illustrations may include optional equipment and not show all possible configurations. These and the technical data are provided as indicative information only, with any errors and misprints reserved.